

# Partial Differential Equations

**Victor Ivrii**

Department of Mathematics,  
University of Toronto

© by Victor Ivrii, 2022,  
Toronto, Ontario, Canada

# Contents

|  |           |
|--|-----------|
| <b>Contents</b>  | <b>i</b>  |
| Preface . . . . .  | v         |
| <b>1 Introduction</b>  | <b>1</b>  |
| 1.1 PDE motivations and context . . . . .                              | 1         |
| 1.2 Initial and boundary value problems . . . . .                      | 7         |
| 1.3 Classification of equations . . . . .                              | 9         |
| 1.4 Origin of some equations . . . . .                                 | 13        |
| Problems to Chapter 1 . . . . .  | 18        |
| <b>2 1-Dimensional Waves</b>   | <b>20</b> |
| 2.1 First order PDEs . . . . .   | 20        |
| Derivation of a PDE describing traffic flow . . . . .                  | 26        |
| Problems to Section 2.1 . . . . .                                      | 29        |
| 2.2 Multidimensional equations . . . . .                               | 32        |
| Problems to Section 2.2 . . . . .                                      | 35        |
| 2.3 Homogeneous 1D wave equation . . . . .                             | 36        |
| Problems to Section 2.3 . . . . .                                      | 40        |
| 2.4 1D-Wave equation reloaded: characteristic coordinates . . . . .    | 45        |
| Problems to Section 2.4 . . . . .                                      | 50        |
| 2.5 Wave equation reloaded (continued) . . . . .                       | 52        |
| 2.6 1D Wave equation: IBVP . . . . .                                   | 59        |
| Problems to Section 2.6 . . . . .                                      | 75        |
| 2.7 Energy integral . . . . .  | 79        |
| Problems to Section 2.7 . . . . .                                      | 82        |
| 2.8 Hyperbolic first order systems with one spatial variable . . . . . | 86        |
| Problems to Section 2.8 . . . . .                                      | 89        |

|          |  |            |
|----------|--|------------|
| <b>3</b> | <b>Heat equation in 1D</b>   | <b>91</b>  |
| 3.1      | Heat equation . . . . .  | 91         |
| 3.2      | Heat equation (miscellaneous) . . . . .  | 98         |
| 3.A      | Project: Walk problem . . . . .  | 106        |
| 3.B      | Self-similar solutions . . . . .   | 108        |
| 3.C      | Schrödinger equation . . . . .   | 110        |
|          | Problems to Chapter 3 . . . . .  | 111        |
| <br>     |  |            |
| <b>4</b> | <b>Separation of Variables and Fourier Series</b>  | <b>118</b> |
| 4.1      | Separation of variables (the first blood) . . . . .  | 118        |
| 4.2      | Eigenvalue problems . . . . .  | 122        |
|          | Problems to Sections 4.1 and 4.2 . . . . .   | 130        |
| 4.3      | Orthogonal systems . . . . .   | 134        |
| 4.4      | Orthogonal systems and Fourier series . . . . .  | 141        |
| 4.5      | Other Fourier series . . . . .   | 148        |
|          | Problems to Sections 4.3–4.5 . . . . .   | 154        |
|          | Appendix 4.A. Negative eigenvalues in Robin problem . . .                                      | 158        |
|          | Appendix 4.B. Multidimensional Fourier series . . . . .  | 161        |
|          | Appendix 4.C. Harmonic oscillator . . . . .  | 164        |
| <br>     |  |            |
| <b>5</b> | <b>Fourier transform</b>   | <b>167</b> |
| 5.1      | Fourier transform, Fourier integral . . . . .  | 167        |
|          | Appendix 5.1.A. Justification . . . . .  | 171        |
|          | Appendix 5.1.A. Discussion: pointwise convergence of<br>Fourier integrals and series . . . . . | 173        |
| 5.2      | Properties of Fourier transform . . . . .  | 175        |
|          | Appendix 5.2.A. Multidimensional Fourier transform,<br>Fourier integral . . . . .              | 179        |
|          | Appendix 5.2.B. Fourier transform in the complex domain  | 181        |
|          | Appendix 5.2.C. Discrete Fourier transform . . . . .   | 184        |
|          | Problems to Sections 5.1 and 5.2 . . . . .   | 185        |
| 5.3      | Applications of Fourier transform to PDEs . . . . .  | 188        |
|          | Problems to Section 5.3 . . . . .  | 195        |
| <br>     |  |            |
| <b>6</b> | <b>Separation of variables</b>   | <b>200</b> |
| 6.1      | Separation of variables for heat equation . . . . .  | 200        |
| 6.2      | Separation of variables: miscellaneous equations . . . . .                                     | 204        |
| 6.3      | Laplace operator in different coordinates . . . . .  | 210        |

|           |   |            |
|-----------|---|------------|
| 6.4       | Laplace operator in the disk . . . . .  | 217        |
| 6.5       | Laplace operator in the disk. II . . . . .                                    | 221        |
| 6.6       | Multidimensional equations . . . . .  | 226        |
|           | Appendix 6.A. Linear second order ODEs . . . . .                              | 229        |
|           | Problems to Chapter 6 . . . . .   | 232        |
| <b>7</b>  | <b>Laplace equation</b>   | <b>236</b> |
| 7.1       | General properties of Laplace equation . . . . .                              | 236        |
| 7.2       | Potential theory and around . . . . .   | 238        |
| 7.3       | Green's function . . . . .  | 245        |
|           | Problems to Chapter 7 . . . . .   | 250        |
| <b>8</b>  | <b>Separation of variables</b>  | <b>256</b> |
| 8.1       | Separation of variables in spherical coordinates . . . . .                    | 256        |
| 8.2       | Separation of variables in polar and cylindrical coordinates . . . . .        | 261        |
|           | Separation of variable in elliptic and parabolic coordinates . . . . .        | 263        |
|           | Problems to Chapter 8 . . . . .   | 265        |
| <b>9</b>  | <b>Wave equation</b>  | <b>268</b> |
| 9.1       | Wave equation in dimensions 3 and 2 . . . . .                                 | 268        |
| 9.2       | Wave equation: energy method . . . . .  | 276        |
|           | Problems to Chapter 9 . . . . .   | 280        |
| <b>10</b> | <b>Variational methods</b>  | <b>282</b> |
| 10.1      | Functionals, extremums and variations . . . . .                               | 282        |
| 10.2      | Functionals, Eextremums and variations (continued) . . . . .                  | 287        |
| 10.3      | Functionals, extremums and variations (multidimensional) . . . . .            | 293        |
| 10.4      | Functionals, extremums and variations (multidimensional, continued) . . . . . | 297        |
| 10.5      | Variational methods in physics . . . . .                                      | 304        |
|           | Appendix 10.A. Nonholonomic mechanics . . . . .                               | 310        |
|           | Problems to Chapter 10 . . . . .  | 311        |
| <b>11</b> | <b>Distributions and weak solutions</b>                                       | <b>317</b> |
| 11.1      | Distributions . . . . .   | 317        |
| 11.2      | Distributions: more . . . . .   | 322        |
| 11.3      | Applications of distributions . . . . .                                       | 327        |
| 11.4      | Weak solutions . . . . .  | 332        |

|   |            |
|---|------------|
| <b>12 Nonlinear equations</b>                         | <b>334</b> |
| 12.1 Burgers equation . . . . .                       | 334        |
| <b>13 Eigenvalues and eigenfunctions</b>              | <b>341</b> |
| 13.1 Variational theory . . . . .                     | 341        |
| 13.2 Asymptotic distribution of eigenvalues . . . . . | 345        |
| 13.3 Properties of eigenfunctions . . . . .           | 353        |
| 13.4 About spectrum . . . . .                         | 363        |
| 13.5 Continuous spectrum and scattering . . . . .     | 370        |
| <b>14 Miscellaneous</b>                               | <b>375</b> |
| 14.1 Conservation laws . . . . .                      | 375        |
| 14.2 Maxwell equations . . . . .                      | 379        |
| 14.3 Some quantum mechanical operators . . . . .      | 380        |
| <b>A Appendices</b>                                   | <b>383</b> |
| A.1 Field theory . . . . .                            | 383        |
| A.2 Some notations . . . . .                          | 387        |

## Preface

This is a snapshot of June 7, 2021 of my online Textbook,

<http://www.math.toronto.edu/ivrii/PDE-textbook/>

This online Textbook based on half-year course APM346 “Partial Differential Equations” at Faculty of Arts and Science, University of Toronto. This is a junior class for all but Math Specialist students.

This Textbook is *free* and *open* (which means that anyone can use it without any permission or fees) and *open-source* (which means that anyone can easily modify it for his or her own needs) and it will remain this way forever. Source (in the form of [Markdown](#)) of each page could be downloaded: this page’s URL is

<http://www.math.toronto.edu/ivrii/PDE-textbook/Chapter0/S0.html>

and its source’s URL is

<http://www.math.toronto.edu/ivrii/PDE-textbook/Chapter0/S0.md>

and for all other pages respectively.

The [Source](#) of the whole book could be downloaded as well. Also could be downloaded [Textbook in pdf format](#) and [TeX Source](#).

Moreover, it will remain free and freely available. Since it free it does not cost anything adding more material, graphics and so on.

This textbook is *maintained*. It means that it could be modified almost instantly if some of students find some parts either not clear enough or contain misprints or errors. PDF version is updated once in few years.

This textbook is *truly digital*. It contains what a printed textbook cannot contain in principle: clickable hyperlinks (both internal and external) and a bit of animation (external). On the other hand, CouseSmart and its ilk provide only a poor man’s digital copy of the printed textbook.

One should remember that you need an internet connection. Even if you save web pages to parse mathematical expression you need MathJax which is loaded from the cloud. However you can print every page to pdf to keep on you computer (or download pdf copy of the whole textbook).

Due to html format it *reflows* and can accommodate itself to the smaller screens of the tablets without using too small fonts. One can read it on smart phones (despite too small screens). On the other hand, pdf does not

reflow but has a *fidelity*: looks exactly the same on any screen. Each version has its own advantages and disadvantages.

True, it is less polished than available printed textbooks but *it is maintained* (which means that errors are constantly corrected, material, especially problems, added).

At Spring of 2019 I was teaching APM346 together with [Richard Derryberry](#) who authored some new problems (and the ideas of some of the new problems as well) and some animations and the idea of adding animations, produced by Mathematica, belongs to him. These animations (animated gifs) are hosted on the webserver of [Department of Mathematics, University of Toronto](#).

## What one needs to know?

### Subjects

#### Required:

1. Multivariable Calculus
2. Ordinary Differential Equations

#### Assets: (useful but not required)

3. Complex Variables,
4. Elements of (Real) Analysis,
5. Any courses in Physics, Chemistry etc using PDEs (taken previously or now).

### 1. Multivariable Calculus

#### Differential Calculus

- (a) Partial Derivatives (first, higher order), differential, gradient, chain rule;
- (b) Taylor formula;
- (c) Extremums, stationary points, classification of stationart points using second derivatives; *Asset*: Extremums with constrains.
- (d) Familiarity with some notations Section A.2.

#### Integral Calculus

- (e) Multidimensional integral, calculations in Cartesian coordinates;
- (f) Change of variables, Jacobian, calculation in polar, cylindrical, spherical coordinates;
- (g) Path, Line, Surface integrals, calculations;



- (h) Green, Gauss, Stokes formulae;
- (i)  $\nabla u$ ,  $\nabla \times A$ ,  $\nabla \cdot A$ ,  $\Delta u$  where  $u$  is a scalar field and  $A$  is a vector field.

## 2. Ordinary Differential Equations

### First order equations

- (a) Definition, Cauchy problem, existence and uniqueness;
- (b) Equations with separating variables, integrable, linear.

### Higher order equations

- (c) Definition, Cauchy problem, existence and uniqueness;

### Linear equations of order $\geq 2$

- (d) General theory, Cauchy problem, existence and uniqueness;
- (e) Linear homogeneous equations, fundamental system of solutions, Wronskian;
- (f) Method of variations of constant parameters.

### Linear equations of order $\geq 2$ with constant coefficients

- (g) Fundamental system of solutions: simple, multiple, complex roots;
- (h) Solutions for equations with quasipolynomial right-hand expressions; method of undetermined coefficients;
- (i) Euler's equations: reduction to equation with constant coefficients. Solving without reduction.

### Systems

- (j) General systems, Cauchy problem, existence and uniqueness;
- (k) Linear systems, linear homogeneous systems, fundamental system of solutions, Wronskian;
- (l) Method of variations of constant parameters;
- (m) Linear systems with constant coefficients.

**Assets**

- (a) ODE with singular points.
- (b) Some special functions.
- (c) Boundary value problems.

# Chapter 1

## Introduction

### 1.1 PDE motivations and context

The aim of this is to introduce and motivate partial differential equations (PDE). The section also places the scope of studies in APM346 within the vast universe of mathematics. A *partial differential equation (PDE)* is an *gather* involving *partial derivatives*. This is not so informative so let's break it down a bit.

#### 1.1.1 What is a differential equation?

An *ordinary differential equation (ODE)* is an equation for a function which depends on one independent variable which involves the independent variable, the function, and derivatives of the function:

$$F(t, u(t), u'(t), u^{(2)}(t), u^{(3)}(t), \dots, u^{(m)}(t)) = 0.$$

This is an example of an ODE of *order*  $m$  where  $m$  is a highest order of the derivative in the equation. Solving an equation like this on an interval  $t \in [0, T]$  would mean finding a function  $t \mapsto u(t) \in \mathbb{R}$  with the property that  $u$  and its derivatives satisfy this equation for all values  $t \in [0, T]$ .

The problem can be enlarged by replacing the real-valued  $u$  by a vector-valued one  $\mathbf{u}(x, y) = (u_1(t), u_2(t), \dots, u_N(t))$ . In this case we usually talk about *system of ODEs*.

Even in this situation, the challenge is to find functions depending upon exactly one variable which, together with their derivatives, satisfy the equation.

### What is a partial derivative?

When you have function that depends upon several variables, you can differentiate with respect to either variable while holding the other variable constant. This spawns the idea of *partial derivatives*. As an example, consider a function depending upon two real variables taking values in the reals:

$$u: \mathbb{R}^n \rightarrow \mathbb{R}.$$

As  $n = 2$  we sometimes visualize a function like this by considering its *graph* viewed as a surface in  $\mathbb{R}^3$  given by the collection of points

$$\{(x, y, z) \in \mathbb{R}^3 : z = u(x, y)\}.$$

We can calculate the derivative with respect to  $x$  while holding  $y$  fixed. This leads to  $u_x$ , also expressed as  $\partial_x u$ ,  $\frac{\partial u}{\partial x}$ , and  $\frac{\partial}{\partial x} u$ . Similarly, we can hold  $x$  fixed and differentiate with respect to  $y$ .

### What is PDE?

A *partial differential equation* is an equation for a function which depends on more than one independent variable which involves the independent variables, the function, and partial derivatives of the function:

$$F(x, y, u(x, y), u_x(x, y), u_y(x, y), u_{xx}(x, y), u_{xy}(x, y), u_{yx}(x, y), u_{yy}(x, y)) = 0.$$

This is an example of a *PDE of order 2*. Solving an equation like this would mean finding a function  $(x, y) \rightarrow u(x, y)$  with the property that  $u$  and its derivatives satisfy this equation for all admissible arguments.

Similarly to ODE case this problem can be enlarged by replacing the real-valued  $u$  by a vector-valued one  $\mathbf{u}(x, y) = (u_1(x, y), u_2(x, y), \dots, u_N(x, y))$ . In this case we usually talk about *system of PDEs*.

### Where PDEs are coming from?

PDEs are often referred as *Equations of Mathematical Physics* (or *Mathematical Physics* but it is incorrect as Mathematical Physics is now a separate field of mathematics) because many of PDEs are coming from different

domains of physics (acoustics, optics, elasticity, hydro and aerodynamics, electromagnetism, quantum mechanics, seismology etc).

However PDEs appear in other fields of science as well (like quantum chemistry, chemical kinetics); some PDEs are coming from economics and financial mathematics, or computer science.

Many PDEs are originated in other fields of mathematics.

### Examples of PDEs

(Some are actually systems)

#### Simplest first order equation

$$u_x = 0.$$

#### Transport equation

$$u_t + cu_x = 0.$$

#### $\bar{\partial}$ equation

$$\bar{\partial}f := \frac{1}{2}(f_x + if_y) = 0,$$

( $\bar{\partial}$  is known as “di-bar” or Wirtinger derivatives), or as  $f = u + iv$

$$\begin{cases} u_x - v_y = 0, \\ u_y + v_x = 0. \end{cases}$$

Those who took *Complex variables* know that those are *Cauchy-Riemann equations*.

#### Laplace’s equation (in 2D)

$$\Delta u := u_{xx} + u_{yy} = 0$$

or similarly in the higher dimensions.

**Heat equation**

$$u_t = k\Delta u;$$

(The expression  $\Delta$  is called the *Laplacian* (*Laplace operator*) and is defined as  $\partial_x^2 + \partial_y^2 + \partial_z^2$  on  $\mathbb{R}^3$ ).

**Schrödinger equation (quantum mechanics)**

$$i\hbar\partial_t\psi = \left(-\frac{\hbar^2}{2m}\Delta + V\right)\psi.$$

Here  $\psi$  is a complex-valued function.

**Wave equation**

$$u_{tt} - c^2\Delta u = 0;$$

sometimes  $\square := c^{-2}\partial_t^2 - \Delta$  is called (*d'Alembertian* or *d'Alembert operator*). It appears in elasticity, acoustics, electromagnetism and so on.

One-dimensional wave equation

$$u_{tt} - c^2u_{xx} = 0$$

often is called *string equation* and describes f.e. a vibrating string.

**Oscillating rod or plate (elasticity)** Equation of vibrating rod (with one spatial variable)

$$u_{tt} + Ku_{xxxx} = 0$$

or vibrating plate (with two spatial variables)

$$u_{tt} + K\Delta^2u = 0.$$

**Maxwell equations (electromagnetism) in vacuum**

$$\begin{cases} \mathbf{E}_t - c\nabla \times \mathbf{H} = 0, \\ \mathbf{H}_t + c\nabla \times \mathbf{E} = 0, \\ \nabla \cdot \mathbf{E} = \nabla \cdot \mathbf{H} = 0. \end{cases}$$

Here  $\mathbf{E}$  and  $\mathbf{H}$  are vectors of electric and magnetic intensities, so the first two lines are actually  $6 \times 6$  system. The third line means two more equations, and we have  $8 \times 6$  system. Such systems are called *overdetermined*.

**Dirac equations (relativistic quantum mechanics)**

$$i\hbar\partial_t\psi = \left(\beta mc^2 - \sum_{1\leq k\leq 3} i\hbar\alpha_k\partial_{x_k}\right)\psi$$

with *Dirac*  $4 \times 4$ -matrices  $\alpha_1, \alpha_2, \alpha_3, \beta$ . Here  $\psi$  is a complex 4-vector, so in fact we have  $4 \times 4$  system.

**Elasticity equations (homogeneous and isotropic)**

$$\mathbf{u}_{tt} = \lambda\Delta\mathbf{u} + \mu\nabla(\nabla \cdot \mathbf{u}).$$

*homogeneous* means “the same in all places” (an opposite is called *inhomogeneous*) and *isotropic* means “the same in all directions” (an opposite is called *anisotropic*).

**Navier-Stokes equation (hydrodynamics for incompressible liquid)**

$$\begin{cases} \rho\mathbf{v}_t + (\mathbf{v} \cdot \nabla)\rho\mathbf{v} - \nu\Delta\mathbf{v} = -\nabla p, \\ \nabla \cdot \mathbf{v} = 0, \end{cases}$$

where  $\rho$  is a (constant) density,  $\mathbf{v}$  is a velocity and  $p$  is the pressure; when viscosity  $\nu = 0$  we get *Euler equation*

$$\begin{cases} \rho\mathbf{v}_t + (\mathbf{v} \cdot \nabla)\rho\mathbf{v} = -\nabla p, \\ \nabla \cdot \mathbf{v} = 0. \end{cases}$$

Both of them are  $4 \times 4$  systems.

**Yang-Mills equation (elementary particles theory)**

$$\begin{aligned} \partial_{x_j}F_{jk} + [A_j, F_{jk}] &= 0, \\ F_{jk} &:= \partial_{x_j}A_k - \partial_{x_k}A_j + [A_j, A_k], \end{aligned}$$

where  $A_k$  are traceless skew-Hermitian matrices. Their matrix elements are unknown functions. This is a 2nd order system.

**Einstein equation for general relativity**

$$G_{\mu\nu} + \Lambda g_{\mu\nu} = \kappa T_{\mu\nu},$$

where  $G_{\mu\nu} = R_{\mu\nu} - \frac{1}{2}g_{\mu\nu}$  is the *Einstein tensor*,  $g_{\mu\nu}$  is the *metric tensor* (unknown functions),  $R_{\mu\nu}$  is the *Ricci curvature tensor*, and  $R$  is the *scalar curvature*,  $T_{\mu\nu}$  is the *stress–energy tensor*,  $\Lambda$  is the *cosmological constant* and  $\kappa$  is the *Einstein gravitational constant*. Components of Ricci curvature tensor are expressed through the components of the metric tensor, their first and second derivatives. This is a 2nd order system.

**Black-Scholes equation** [Black-Scholes Equation](#) (Financial mathematics) is a partial differential equation (PDE) governing the price evolution of a European call or European put under the Black–Scholes model. Broadly speaking, the term may refer to a similar PDE that can be derived for a variety of options, or more generally, derivatives:

$$\frac{\partial V}{\partial t} + \frac{1}{2}\sigma^2 S^2 \frac{\partial^2 V}{\partial S^2} + rS \frac{\partial V}{\partial S} - rV = 0$$

where  $V$  is the price of the option as a function of stock price  $S$  and time  $t$ ,  $r$  is the risk-free interest rate, and  $\sigma$  is the volatility of the stock.

Do not ask me what this means!

*Remark 1.1.1.* (a) Some of these examples are actually not single PDEs but the systems of PDEs.

(b) In all these examples there are *spatial variables*  $x, y, z$  and often *time variable*  $t$  but it is not necessarily so in all PDEs. Equations, not including time, are called *stationary* (an opposite is called *nonstationary*).

(c) Equations could be of different order with respect to different variables and it is important. However if not specified the order of equation is the highest order of the derivatives invoked.

(d) In this class we will deal mainly with the wave equation, heat equation and Laplace equation in their simplest forms.



## 1.2 Initial and boundary value problems

### 1.2.1 Problems for PDEs

We know that solutions of ODEs typically depend on one or several constants. For PDEs situation is more complicated. Consider simplest equations

$$u_x = 0, \quad (1.2.1)$$

$$v_{xx} = 0 \quad (1.2.2)$$

$$w_{xy} = 0 \quad (1.2.3)$$

with  $u = u(x, y)$ ,  $v = v(x, y)$  and  $w = w(x, y)$ . Equation (1.2.1) could be treated as an ODE with respect to  $x$  and its solution is a constant but this is not a genuine constant as *it is constant only with respect to  $x$  and can depend on other variables*; so  $u(x, y) = \phi(y)$ .

Meanwhile, for solution of (1.2.2) we have  $v_x = \phi(y)$  where  $\phi$  is an arbitrary function of one variable and it could be considered as ODE with respect to  $x$  again; then  $v(x, y) = \phi(y)x + \psi(y)$  where  $\psi(y)$  is another arbitrary function of one variable.

Finally, for solution of (1.2.3) we have  $w_y = \phi(y)$  where  $\phi$  is an arbitrary function of one variable and it could be considered as ODE with respect to  $y$ ; then  $(w - g(y))_y = 0$  where  $g(y) = \int \phi(y) dy$ , and therefore  $w - g(y) = f(x) \implies w(x, y) = f(x) + g(y)$  where  $f, g$  are *arbitrary functions* of one variable.

Considering these equations again but assuming that  $u = u(x, y, z)$ ,  $v = v(x, y, z)$  we arrive to  $u = \phi(y, z)$ ,  $v = \phi(y, z)x + \psi(y, z)$  and  $w = f(x, z) + g(y, z)$  where  $f, g$  are arbitrary functions of two variables.

Solutions to PDEs typically depend not on several arbitrary constants but on one or several arbitrary functions of  $n - 1$  variables. For more complicated equations this dependence could be much more complicated and implicit. To select a right solutions we need to use some extra conditions.

The sets of such conditions are called *Problems*. Typical problems are

- (a) IVP (*Initial Value Problem*): one of variables is interpreted as *time*  $t$  and conditions are imposed at some moment; f.e.  $u|_{t=t_0} = u_0$ ;
- (b) BVP (*Boundary Value Problem*) conditions are imposed on the boundary of the spatial domain  $\Omega$ : f.e.  $u|_{\partial\Omega} = \phi$  where  $\partial\Omega$  is a boundary of  $\Omega$  and  $\phi$  is defined on  $\partial\Omega$ ;

- (c) IVBP (*Initial-Boundary Value Problem* a.k.a. *mixed problem*): one of variables is interpreted as *time*  $t$  and some conditions are imposed at some moment but other conditions are imposed on the boundary of the spatial domain.

*Remark 1.2.1.* In the course of ODEs students usually consider IVP only. F.e. for the second-order equation like

$$u_{xx} + a_1 u_x + a_2 u = f(x)$$

such problem is  $u|_{x=x_0} = u_0$ ,  $u_x|_{x=x_0} = u_1$ . However one could consider BVPs like

$$\begin{aligned}(\alpha_1 u_x + \beta_1 u)|_{x=x_1} &= \phi_1, \\(\alpha_2 u_x + \beta_2 u)|_{x=x_2} &= \phi_2,\end{aligned}$$

where solutions are sought on the interval  $[x_1, x_2]$ . Such are covered in advanced chapters of some of ODE textbooks (but not covered by a typical ODE class). We will need to cover such problems later in this class.

### 1.2.2 Notion of “well-posedness”

We want that our PDE (or the system of PDEs) together with all these conditions satisfied the following requirements:

- (a) Solutions must exist for all right-hand expressions (in equations and conditions)—*existence*;
- (b) Solution must be unique—*uniqueness*;
- (c) Solution must depend on these right-hand expressions continuously, which means that small changes in the right-hand expressions lead to small changes in the solution.

Such problems are called *well-posed*. PDEs are usually studied together with the problems which are well-posed for these PDEs. Different types of PDEs *admit* different problems.

Sometimes however one needs to consider *ill-posed* problems. In particular, *inverse problems* of PDEs are almost always ill-posed.

## 1.3 Classification of equations

### 1.3.1 Linear and nonlinear equations

Equations of the form

$$Lu = f(\mathbf{x}) \quad (1.3.1)$$

where  $Lu$  is a partial differential expression linear with respect to unknown function  $u$  is called *linear equation* (or *linear system*). This equation is *linear homogeneous equation* if  $f = 0$  and *linear inhomogeneous equation* otherwise. For example,

$$Lu := a_{11}u_{xx} + 2a_{12}u_{xy} + a_{22}u_{yy} + a_1u_x + a_2u_y + au = f(\mathbf{x}) \quad (1.3.2)$$

is linear; if all coefficients  $a_{jk}$ ,  $a_j$ ,  $a$  are constant, we call it *linear equation with constant coefficients*; otherwise we talk about *variable coefficients*.

Otherwise equation is called *nonlinear*. However there is a more subtle classification of such equations. Equations of the type (1.3.1), where the right-hand expression  $f$  depends on the solution and its lower-order derivatives, are called *semilinear*, equations where both coefficients and right-hand expression depend on the solution and its lower-order derivatives are called *quasilinear*. For example,

$$Lu := a_{11}(x, y)u_{xx} + 2a_{12}(x, y)u_{xy} + a_{22}(x, y)u_{yy} = f(x, y, u, u_x, u_y) \quad (1.3.3)$$

is semilinear, and

$$Lu := a_{11}(x, y, u, u_x, u_y)u_{xx} + 2a_{12}(x, y, u, u_x, u_y)u_{xy} + a_{22}(x, y, u, u_x, u_y)u_{yy} = f(x, y, u, u_x, u_y) \quad (1.3.4)$$

is quasilinear, while

$$F(x, y, u, u_x, u_y, u_{xx}, u_{xy}, u_{yx}) = 0 \quad (1.3.5)$$

is general nonlinear.

### 1.3.2 Elliptic, hyperbolic and parabolic equations

**General** Consider second order equation (1.3.2):

$$Lu := \sum_{1 \leq i, j \leq n} a_{ij}u_{x_i x_j} + \text{l.o.t.} = f(\mathbf{x}) \quad (1.3.6)$$

where l.o.t. means *lower order terms* (that is, terms with  $u$  and its lower order derivatives) with  $a_{ij} = a_{ji}$ . Let us change variables  $\mathbf{x} = \mathbf{x}(\mathbf{x}')$ . Then the *matrix of principal coefficients*

$$A = \begin{pmatrix} a_{11} & \cdots & a_{1n} \\ \vdots & \ddots & \vdots \\ a_{n1} & \cdots & a_{nn} \end{pmatrix}$$

in the new coordinate system becomes  $A' = Q^* A Q$  where  $Q = T^{*-1}$  and  $T = \left( \frac{\partial x_i}{\partial x'_j} \right)_{i,j=1,\dots,n}$  is a Jacobi matrix. The proof easily follows from the *chain rule* (Calculus II).

Therefore if the principal coefficients are real and constant, by a linear change of variables matrix of the principal coefficients could be reduced to the diagonal form, where diagonal elements could be either 1, or  $-1$  or 0. Multiplying equation by  $-1$  if needed we can assume that there are at least as many 1 as  $-1$ . In particular, for  $n = 2$  the principal part becomes either  $u_{xx} + u_{yy}$ , or  $u_{xx} - u_{yy}$ , or  $u_{xx}$  and such equations are called *elliptic*, *hyperbolic*, and *parabolic* respectively (there will be always second derivative since otherwise it would be the first order equation).

This terminology comes from the curves of the second order *conical sections*: if  $a_{11}a_{22} - a_{12}^2 > 0$  equation

$$a_{11}\xi^2 + 2a_{12}\xi\eta + a_{22}\eta^2 + a_1\xi + a_2\eta = c$$

generically defines an ellipse, if  $a_{11}a_{22} - a_{12}^2 < 0$  this equation generically defines a hyperbole and if  $a_{11}a_{22} - a_{12}^2 = 0$  it defines a parabole.

Let us consider equations in different dimensions:

**2D** If we consider only 2-nd order equations with constant real coefficients then in appropriate coordinates they will look like either

$$u_{xx} + u_{yy} + \text{l.o.t} = f \tag{1.3.7}$$

or

$$u_{xx} - u_{yy} + \text{l.o.t} = f, \tag{1.3.8}$$

where l.o.t. mean *lower order terms*, and we call such equations *elliptic* and *hyperbolic* respectively.

What to do if one of the 2-nd derivatives is missing? We get *parabolic equations*

$$u_{xx} - cu_y + \text{l.o.t.} = f. \quad (1.3.9)$$

with  $c \neq 0$  (we do not consider  $cu_y$  as a lower order term here) and IVP  $u|_{y=0} = g$  is well-posed in the direction of  $y > 0$  if  $c > 0$  and in direction  $y < 0$  if  $c < 0$ . We can dismiss  $c = 0$  as not-interesting.

However this classification leaves out very important Schrödinger equation

$$u_{xx} + icu_y = 0 \quad (1.3.10)$$

with real  $c \neq 0$ . For it IVP  $u|_{y=0} = g$  is well-posed in both directions  $y > 0$  and  $y < 0$  but it lacks many properties of parabolic equations (like maximum principle or mollification; still it has interesting properties on its own).

**3D** Again, if we consider only 2-nd order equations with constant real coefficients, then in appropriate coordinates they will look like either

$$u_{xx} + u_{yy} + u_{zz} + \text{l.o.t} = f \quad (1.3.11)$$

or

$$u_{xx} + u_{yy} - u_{zz} + \text{l.o.t.} = f, \quad (1.3.12)$$

and we call such equations *elliptic* and *hyperbolic* respectively.

Also we get *parabolic equations* like

$$u_{xx} + u_{yy} - cu_z + \text{l.o.t.} = f. \quad (1.3.13)$$

What about

$$u_{xx} - u_{yy} - cu_z + \text{l.o.t.} = f? \quad (1.3.14)$$

Algebraist-formalist would call it parabolic-hyperbolic but since this equation exhibits no interesting analytic properties (unless one considers lack of such properties interesting; in particular, IVP is ill-posed in both directions) it would be a perversion.

Yes, there will be Schrödinger equation

$$u_{xx} + u_{yy} + icu_z = 0 \quad (1.3.15)$$

with real  $c \neq 0$  but  $u_{xx} - u_{yy} + icu_z = 0$  would also have IVP  $u|_{z=0} = g$  well-posed in both directions.

**4D** Here we would get also *elliptic*

$$u_{xx} + u_{yy} + u_{zz} + u_{tt} + \text{l.o.t.} = f, \quad (1.3.16)$$

*hyperbolic*

$$u_{xx} + u_{yy} + u_{zz} - u_{tt} + \text{l.o.t.} = f, \quad (1.3.17)$$

but also *ultrahyperbolic*

$$u_{xx} + u_{yy} - u_{zz} - u_{tt} + \text{l.o.t.} = f, \quad (1.3.18)$$

which exhibits some interesting analytic properties but these equations are way less important than elliptic, hyperbolic or parabolic.

Parabolic and Schrödinger will be here as well.

*Remark 1.3.1.* (a) The notions of elliptic, hyperbolic or parabolic equations are generalized to higher dimensions (trivially) and to higher-order equations, but most of the randomly written equations do not belong to any of these types and there is no reason to classify them.

(b) There is no complete classifications of PDEs and cannot be because any reasonable classification should not be based on how equation looks like but on the reasonable analytic properties it exhibits (which IVP or BVP are well-posed etc).

**Equations of the variable type** To make things even more complicated there are equations changing types from point to point, f.e. [Tricomi equation](#)

$$u_{xx} + xu_{yy} = 0 \quad (1.3.19)$$

which is elliptic as  $x > 0$  and hyperbolic as  $x < 0$  and at  $x = 0$  has a “parabolic degeneration”. It is a toy-model describing stationary transsonic flow of gas. These equations are called *equations of the variable type* (a.k.a. *mixed type equations*).

Our purpose was not to give exact definitions but to explain a situation.

### 1.3.3 Scope of this Textbook

- We mostly consider *linear* PDE problems.
- We mostly consider *well-posed problems*.
- We mostly consider problems with *constant coefficients*.
- We do not consider *numerical methods*.

## 1.4 Origin of some equations

### 1.4.1 Wave equation

*Example 1.4.1.* Consider a string as a curve  $y = u(x, t)$  (so its shape depends on time  $t$ ) with a tension  $T$  and with a linear density  $\rho$ . We assume that  $|u_x| \ll 1$ .

Observe that at point  $x$  the part of the string to the left from  $x$  pulls it up with a force  $-F(x) := -Tu_x$ .

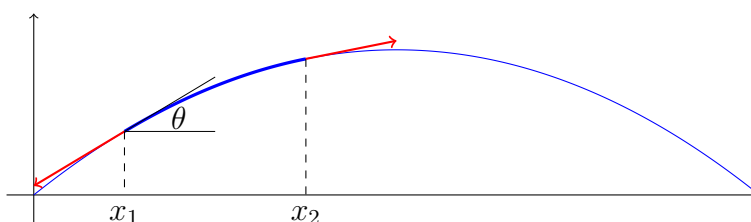

Indeed, the force  $T$  is directed along the curve and the slope of angle  $\theta$  between the tangent to the curve and the horizontal line is  $u_x$ ; so  $\sin(\theta) = u_x / \sqrt{1 + u_x^2}$  which under our assumption we can replace by  $u_x$ .

*Example 1.4.1 (continued).* On the other hand, at point  $x$  the part of the string to the right from  $x$  pulls it up with a force  $F(x) := Tu_x$ . Therefore the total  $y$ -component of the force applied to the segment of the string between  $J = [x_1, x_2]$  equals

$$F(x_2) - F(x_1) = \int_J \partial_x F(x) dx = \int_J Tu_{xx} dx.$$

According to Newton's law it must be equal to  $\int_J \rho u_{tt} dx$  where  $\rho dx$  is the mass and  $u_{tt}$  is the acceleration of the infinitesimal segment  $[x, x + dx]$ :

$$\int_J \rho u_{tt} dx = \int_J Tu_{xx} dx.$$

Since this equality holds for any segment  $J$ , the integrands coincide:

$$\rho u_{tt} = Tu_{xx}. \quad (1.4.1)$$

*Example 1.4.2.* Consider a membrane as a surface  $z = u(x, y, t)$  with a tension  $T$  and with a surface density  $\rho$ . We assume that  $|u_x|, |u_y| \ll 1$ .

Consider a domain  $D$  on the plane, its boundary  $L$  and a small segment of the length  $ds$  of this boundary. Then the outer domain pulls this segment up with the force  $-T\mathbf{n} \cdot \nabla u ds$  where  $\mathbf{n}$  is the *inner* unit normal to this segment.

Indeed, the total force is  $T ds$  but it pulls along the surface and the slope of the surface in the direction of  $\mathbf{n}$  is  $\approx \mathbf{n} \cdot \nabla u$ .

Therefore the total  $z$ -component of force applied to  $D$  due to Gauss formula in dimension 2 (A.1.1) equals

$$-\int_L T\mathbf{n} \cdot \nabla u ds = \iint_D \nabla \cdot (T\nabla u) dx dy.$$

According to Newton's law it must be equal to  $\iint_D \rho u_{tt} dx dy$  where  $\rho dx dy$  is the mass and  $u_{tt}$  is the acceleration of the element of the area:

$$\iint_D \rho u_{tt} dx dy = \iint_D T \Delta u dx$$

because  $\nabla \cdot (T\nabla u) = T\nabla \cdot \nabla u = T\Delta u$ . Since this equality holds for any domain, the integrands coincide:

$$\rho u_{tt} = T \Delta u. \quad (1.4.2)$$

*Example 1.4.3.* Consider a gas and let  $\mathbf{v}$  be its velocity and  $\rho$  its density. Then

$$\rho \mathbf{v}_t + \rho(\mathbf{v} \cdot \nabla)\mathbf{v} = -\nabla p, \quad (1.4.3)$$

$$\rho_t + \nabla \cdot (\rho \mathbf{v}) = 0 \quad (1.4.4)$$

where  $p$  is the pressure. Indeed, in (1.4.3) the left-hand expression is  $\rho \frac{d\mathbf{v}}{dt}$  (the mass per unit of the volume multiplied by acceleration) and the right hand expression is the force of the pressure; no other forces are considered.

problem Further, (1.4.4) is *continuity equation* which means the mass conservation since the flow of the mass through the surface element  $dS$  in the direction of the normal  $\mathbf{n}$  for time  $dt$  equals  $\rho \mathbf{n} \cdot \mathbf{v}$ .

*Remark 1.4.1.* According to the chain rule

$$\frac{du}{dt} = \frac{\partial u}{\partial t} + (\nabla u) \cdot \frac{d\mathbf{x}}{dt} = u_t + (\nabla u) \cdot \mathbf{v}$$

is a *derivative of  $u$  along trajectory* which does not coincide with the *partial derivative*  $u_t$ ;  $\mathbf{v} \cdot \nabla u$  is called *convection term*. However in the linearization with  $|\mathbf{v}| \ll 1$  it is negligible.



*Remark 1.4.2.* Consider any domain  $V$  with a border  $\Sigma$ . The flow of the gas inwards for time  $dt$  equals

$$\iint_{\Sigma} \rho \mathbf{v} \cdot \mathbf{n} \, dS dt = - \iiint_V \nabla \cdot (\rho \mathbf{v}) \, dx dy dz \times dt$$

again due to Gauss formula (A.1.2). This equals to the increment of the mass in  $V$

$$\partial_t \iiint_V \rho \, dx dy dz \times dt = \iiint_V \rho_t \, dx dy dz \times dt.$$

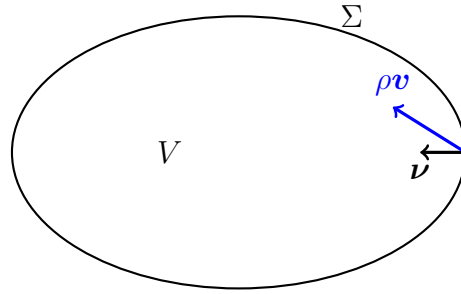

*Remark 1.4.3 (continued).* Therefore

$$- \iiint_V \nabla \cdot (\rho \mathbf{v}) \, dx dy dz = \iiint_V \rho_t \, dx dy dz$$

Since this equality holds for *any* domain  $V$  we can drop integral and arrive to

$$\rho_t + \nabla \cdot (\rho \mathbf{v}) = 0. \quad (4)$$

*Example 1.4.3 (continued).* We need to add  $p = p(\rho, T)$  where  $T$  is the temperature, but we assume  $T$  is constant. Assuming that  $\mathbf{v}$ ,  $\rho - \rho_0$  and their first derivatives are small ( $\rho_0 = \text{const}$ ) we arrive instead to

$$\rho_0 \mathbf{v}_t = -p'(\rho_0) \nabla \rho, \quad (1.4.5)$$

$$\rho_t + \rho_0 \nabla \cdot \mathbf{v} = 0 \quad (1.4.6)$$

and then applying  $\nabla \cdot$  to (1.4.5) and  $\partial_t$  to (1.4.6) we arrive to

$$\rho_{tt} = c^2 \Delta \rho \quad (1.4.7)$$

with  $c = \sqrt{p'(\rho_0)}$  is the speed of sound.

### 1.4.2 Diffusion equation

*Example 1.4.4 (Diffusion Equation).* Let  $u$  be a concentration of perfume in the still air. Consider some volume  $V$ , then the quantity of the perfume in  $V$  at time  $t$  equals  $\iiint_V u \, dx \, dy \, dz$  and its increment for time  $dt$  equals

$$\iiint_V u_t \, dx \, dy \, dz \times dt.$$

On the other hand, the law of diffusion states that the flow of perfume through the surface element  $dS$  in the direction of the normal  $\mathbf{n}$  for time  $dt$  equals  $-k \nabla u \cdot \mathbf{n} \, dS \, dt$  where  $k$  is a *diffusion coefficient* and therefore the flow of the perfume into  $V$  from outside for time  $dt$  equals

$$- \iint_{\Sigma} k \nabla u \cdot \mathbf{n} \, dS \times dt = \iiint_V \nabla \cdot (k \nabla u) \, dx \, dy \, dz \times dt$$

due to Gauss formula (A.1.1.2).

Therefore if there are neither sources nor sinks (negative sources) in  $V$  these two expression must be equal

$$\iiint_V u_t \, dx \, dy \, dz = \iiint_V \nabla \cdot (k \nabla u) \, dx \, dy \, dz$$

where we divided by  $dt$ . Since these equalities must hold for any volume the integrands must coincide and we arrive to *continuity equation*:

$$u_t = \nabla \cdot (k \nabla u). \quad (1.4.8)$$

If  $k$  is constant we get

$$u_t = k \Delta u. \quad (1.4.9)$$

*Example 1.4.5 (Heat Equation).* Consider heat propagation. Let  $T$  be a temperature. Then the heat energy contained in the volume  $V$  equals  $\iiint_V Q(T) \, dx \, dy \, dz$  where  $Q(T)$  is a *heat energy density*. On the other hand, the heat flow (the flow of the heat energy) through the surface element  $dS$  in the direction of the normal  $\mathbf{n}$  for time  $dt$  equals  $-k \nabla T \cdot \mathbf{n} \, dS \, dt$  where  $k$  is a *thermoconductivity coefficient*. Applying the same arguments as above we arrive to

$$Q_t = \nabla \cdot (k \nabla T). \quad (1.4.10)$$

which we rewrite as

$$cT_t = \nabla \cdot (k\nabla T). \quad (1.4.11)$$

where  $c = \frac{\partial Q}{\partial T}$  is a *thermcapacity coefficient*.

If both  $c$  and  $k$  are constant we get

$$cT_t = k\Delta T. \quad (1.4.12)$$

In the real life  $c$  and  $k$  depend on  $T$ . Further,  $Q(T)$  has jumps at *phase transition temperature*. For example to melt an ice to a water (both at  $0^\circ$ ) requires a lot of heat and to boil the water to a vapour (both at  $100^\circ$ ) also requires a lot of heat.

### 1.4.3 Laplace equation

*Example 1.4.6.* Considering all examples above and assuming that unknown function does not depend on  $t$  (and thus replacing corresponding derivatives by 0), we arrive to the corresponding *stationary equations* the simplest of which is Laplace equation

$$\Delta u = 0. \quad (1.4.13)$$

*Example 1.4.7.* In the theory of complex variables one studies holomorphic (analytic) *complex-valued* function  $f(z)$  satisfying a Cauchy-Riemann equation  $\partial_{\bar{z}}f = 0$ . Here  $z = x + iy$ ,  $f = u(x, y) + iv(x, y)$  with *real-valued*  $u = u(x, y)$  and  $v = v(x, y)$  and  $\partial_{\bar{z}} = \frac{1}{2}(\partial_x + i\partial_y)$ ; then this equation could be rewritten as

$$\partial_x u - \partial_y v = 0, \quad (1.4.14)$$

$$\partial_x v + \partial_y u = 0, \quad (1.4.15)$$

which imply that both  $u, v$  satisfy Laplace equation (1.4.13).

Indeed, differentiating the first equation by  $x$  and the second by  $y$  and adding we get  $\Delta u = 0$ , and differentiating the second equation by  $x$  and the first one by  $y$  and subtracting we get  $\Delta v = 0$ .

## Problems to Chapter 1

*Problem 1.* Consider first order equations and determine if they are linear homogeneous, linear inhomogeneous, or nonlinear ( $u$  is an unknown function); for nonlinear equations, indicate if they are also semilinear, or quasilinear<sup>1)</sup>:

$$\begin{array}{ll} u_t + xu_x = 0; & u_t + uu_x = 0; \\ u_t + xu_x - u = 0; & u_t + uu_x + x = 0; \\ u_t + u_x - u^2 = 0; & u_t^2 - u_x^2 - 1 = 0; \\ u_x^2 + u_y^2 - 1 = 0; & xu_x + yu_y + zu_z = 0; \\ u_x^2 + u_y^2 + u_z^2 - 1 = 0; & u_t + u_x^2 + u_y^2 = 0. \end{array}$$

*Problem 2.* Consider equations and determine their order; determine if they are linear homogeneous, linear inhomogeneous or non-linear ( $u$  is an unknown function); you need to provide *the most precise* (that means the narrow, but still correct) description:

$$\begin{array}{ll} u_t + (1 + x^2)u_{xx} = 0; & u_t - (1 + u^2)u_{xx} = 0; \\ u_t + u_{xxx} = 0, & u_t + uu_x + u_{xxx} = 0; \\ u_{tt} + u_{xxxx} = 0; & u_{tt} + u_{xxxx} + u = 0; \\ u_{tt} + u_{xxxx} + \sin(x) = 0; & u_{tt} + u_{xxxx} + \sin(x) \sin(u) = 0. \end{array}$$

*Problem 3.* Find the general solutions to the following equations:

$$\begin{array}{ll} u_{xy} = 0; & u_{xy} = 2u_x; \\ u_{xy} = e^{x+y} & u_{xy} = 2u_x + e^{x+y}. \end{array}$$

*Hint.* Introduce  $v = u_x$  and find it first.

---

<sup>1)</sup>  $F(x, y, u, u_x, u_y) = 0$  is *non-linear* unless

$$F := au_x + bu_y + cu - f \tag{1.16}$$

with  $a = a(x, y)$ ,  $b = b(x, y)$ ,  $c = c(x, y)$  and  $f = f(x, y)$ , when it is *linear homogeneous* for  $f(x, y) = 0$  and *linear inhomogeneous* otherwise. If

$$F := au_x + bu_y - f \tag{1.17}$$

with  $a = a(x, y, u)$ ,  $b = b(x, y, u)$  and  $f = f(x, y, u)$  (so it is linear with respect to (highest order) derivatives, it is called *quasilinear*, and if in addition  $a = a(x, y)$ ,  $b = b(x, y)$ , it is called *semilinear*. This definition obviously generalizes to higher dimensions and orders.

*Problem 4.* Find the general solutions to the following equations:

$$uu_{xy} = u_x u_y; \quad uu_{xy} = 2u_x u_y; \quad u_{xy} = u_x u_y.$$

*Hint.* Divide two first equations by  $uu_x$  and observe that both the right and left-hand expressions are derivative with respect to  $y$  of  $\ln(u_x)$  and  $\ln(u)$  respectively. Divide the last equation by  $u_x$ .

*Problem 5.* Find the general solutions to the following *linear homogeneous equations*:

$$\begin{array}{ll} u_{xxy} = 0, & u_{xxyy} = 0, \\ u_{xxy} = 0, & u_{xyz} = 0, \\ u_{xyzz} = 0, & u_{xxy} = \sin(x) \sin(y), \\ u_{xxy} = \sin(x) + \sin(y), & u_{xxyy} = \sin(x) \sin(y), \\ u_{xxyy} = \sin(x) + \sin(y), & u_{xxyy} = \sin(x) \sin(y), \\ u_{xxyy} = \sin(x) + \sin(y), & u_{xyz} = \sin(x) \sin(y) \sin(z), \\ u_{xyz} = \sin(x) + \sin(y) + \sin(z), & u_{xyz} = \sin(x) + \sin(y) \sin(z). \end{array}$$

*Problem 6.* Find the general solutions to the following *overdetermined systems*:

$$\begin{array}{ll} \begin{cases} u_{xx} = 0, \\ u_y = 0; \end{cases} & \begin{cases} u_{xy} = 0, \\ u_{xz} = 0; \end{cases} \\ \begin{cases} u_{xy} = 0, \\ u_{xz} = 0, \\ u_{yz} = 0; \end{cases} & \begin{cases} u_{xx} = 6xy, \\ u_y = x^3; \end{cases} \\ \begin{cases} u_{xx} = 6xy, \\ u_y = -x^3. \end{cases} & \end{array}$$

*Hint.* Solve one of the equations and plugging the result to another, specify an arbitrary function (or functions) in it, and write down the final answer. Often overdetermined systems do not have solutions; f.e.

$$\begin{cases} u_x = M(x, y), \\ u_y = N(x, y) \end{cases} \quad (1.18)$$

has a solution iff  $M_y - N_x = 0$ .

# Chapter 2

## 1-Dimensional Waves

In this Chapter we first consider first order PDE and then move to 1-dimensional wave equation which we analyze by the *method of characteristics*.

### 2.1 First order PDEs

#### 2.1.1 Introduction

Consider PDE

$$au_t + bu_x = 0. \quad (2.1.1)$$

Note that the left-hand expression is a *derivative of  $u$  along vector field  $\ell = (a, b)$* . Consider an *integral lines* of this vector field:

$$\frac{dt}{a} = \frac{dx}{b}. \quad (2.1.2)$$

*Remark 2.1.1.* (a) Recall from ODE course that an *integral line* of the vector field is a line, tangent to it in each point.

(b) Often it is called *directional derivative* but also often then  $\ell$  is *normalized*, replaced by the unit vector of the same direction  $\ell^0 = \ell/|\ell|$ .

#### 2.1.2 Constant coefficients

If  $a$  and  $b$  are constant then integral curves are just straight lines  $t/a - x/b = C$  where  $C$  is a constant along integral curves and it labels them (at least as

long as we consider the whole plane  $(x, t)$ . Therefore  $u$  depends *only* on  $C$ :

$$u = \phi\left(\frac{t}{a} - \frac{x}{b}\right) \quad (2.1.3)$$

where  $\phi$  is an arbitrary function.

This is a *general solution* of our equation.

Consider initial value condition  $u|_{t=0} = f(x)$ . It allows us define  $\phi$ :  $\phi(-x/b) = f(x) \implies \phi(x) = f(-bx)$ . Plugging in  $u$  we get

$$u = f(x - ct) \quad \text{with } c = b/a. \quad (2.1.4)$$

It is a solution of IVP

$$\begin{cases} au_t + bu_x = 0, \\ u(x, 0) = f(x). \end{cases} \quad (2.1.5)$$

Obviously we need to assume that  $a \neq 0$ .

Also we can rewrite general solution in the form  $u(x, t) = f(x - ct)$  where now  $f(x)$  is another arbitrary function.

**Definition 2.1.1.** Solutions  $u = \chi(x - ct)$  are *running waves* where  $c$  is a *propagation speed*.

### visual examples

### 2.1.3 Variable coefficients

If  $a$  and/or  $b$  are not constant these integral lines are curves.

*Example 2.1.1.* Consider equation  $u_t + tu_x = 0$ . Then equation of the integral curve is  $\frac{dt}{1} = \frac{dx}{t}$  or equivalently  $t dt - dx = 0$  which solves as  $x - \frac{1}{2}t^2 = C$  and therefore  $u = \phi(x - \frac{1}{2}t^2)$  is a general solution to this equation.

One can see easily that  $u = f(x - \frac{1}{2}t^2)$  is a solution of IVP.

*Example 2.1.2.* (a) Consider the same equation  $u_t + tu_x = 0$  but let us consider IVP as  $x = 0$ :  $u(0, t) = g(t)$ . However it is not a good problem: first, some integral curves intersect line  $x = 0$  more than once and if in different points of intersection of the same curve initial values are different we get a contradiction (therefore problem is not solvable for  $g$  which are not even functions).

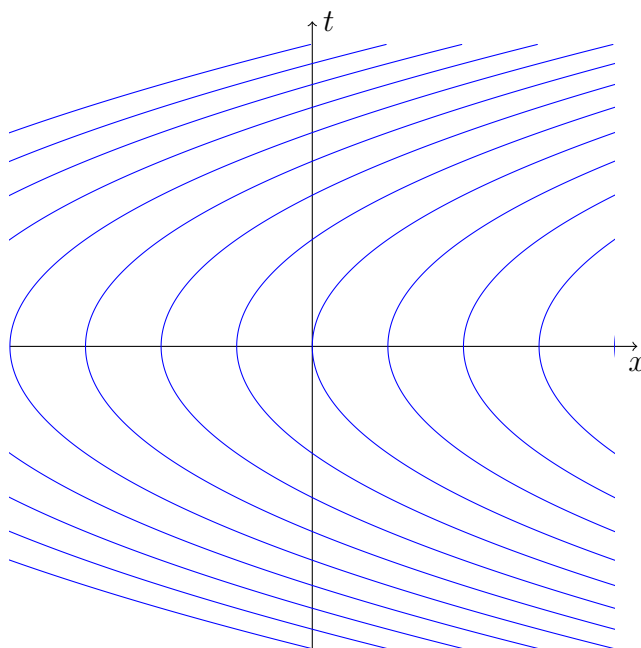

(b) On the other hand, if we consider even function  $g$  (or equivalently impose initial condition only for  $t > 0$ ) then  $u$  is not defined on the curves which are not intersecting  $x = 0$  (which means that  $u$  is not defined for  $x > \frac{1}{2}t^2$ .)

In Part (a) of this example both *solvability* and *uniqueness* are broken; in Part (b) only *uniqueness* is broken. But each integral line intersects  $\{(x, t) : t = 0\}$  exactly once, so IVP of Example 2.1.1 is *well-posed*.

### 2.1.4 Right-hand expression

Consider the same equation albeit with the right-hand expression

$$au_t + bu_x = f, \quad f = f(x, t, u). \quad (2.1.6)$$

Then as  $\frac{dt}{a} = \frac{dx}{b}$  we have  $du = u_t dt + u_x dx = (au_t + bu_x) \frac{dt}{a} = f \frac{dt}{a}$  and therefore we expand our ordinary equation (2.1.2) to

$$\frac{dt}{a} = \frac{dx}{b} = \frac{du}{f}. \quad (2.1.7)$$



*Example 2.1.3.* Consider problem  $u_t + u_x = x$ . Then  $\frac{dx}{1} = \frac{dt}{1} = \frac{du}{x}$ .

Then  $x - t = C$  and  $u - \frac{1}{2}x^2 = D$  and we get  $u - \frac{1}{2}x^2 = \phi(x - t)$  as relation between  $C$  and  $D$  both of which are constants along integral curves. Here  $\phi$  is an arbitrary function. So  $u = \frac{1}{2}x^2 + \phi(x - t)$  is a *general solution*.

Imposing initial condition  $u|_{t=0} = 0$  (sure, we could impose another condition) we have  $\phi(x) = -\frac{1}{2}x^2$  and plugging into  $u$  we get

$$u(x, t) = \frac{1}{2}x^2 - \frac{1}{2}(x - t)^2 = xt - \frac{1}{2}t^2.$$

*Example 2.1.4.* Consider  $u_t + xu_x = xt$ . Then  $\frac{dt}{1} = \frac{dx}{x} = \frac{du}{xt}$ . Solving the first equation  $t - \ln(x) = -\ln(C) \implies x = Ce^t$  we get integral curves.

Now we have

$$\begin{aligned} \frac{du}{xt} = dt &\implies du = xt dt = Cte^t dt \\ &\implies u = C(t - 1)e^t + D = x(t - 1) + D \end{aligned}$$

where  $D$  must be constant along integral curves and therefore  $D = \phi(xe^{-t})$  with an arbitrary function  $\phi$ . So  $u = x(t - 1) + \phi(xe^{-t})$  is a general solution of this equation.

Imposing initial condition  $u|_{t=0} = 0$  (sure, we could impose another condition) we have  $\phi(x) = x$  and then  $u = x(t - 1 + e^{-t})$ .

### 2.1.5 Linear and semilinear equations

**Definition 2.1.2.** (a) If  $a = a(x, t)$  and  $b = b(x, t)$  equation is *semilinear*. In this case we first define integral curves which do not depend on  $u$  and then find  $u$  as a solution of ODE along these curves.

(b) Furthermore if  $f$  is a linear function of  $u$ :  $f = c(x, t)u + g(x, t)$  original equation is *linear*. In this case the last ODE is also linear.

*Example 2.1.5.* Consider  $u_t + xu_x = u$ . Then  $\frac{dt}{1} = \frac{dx}{x} = \frac{du}{u}$ . Solving the first equation  $t - \ln(x) = -\ln(C) \implies x = Ce^t$  we get integral curves. Now we have

$$\frac{du}{u} = dt \implies \ln(u) = t + \ln(D) \implies u = De^t = \phi(xe^{-t})e^t$$

which is a general solution of this equation.

Imposing initial condition  $u|_{t=0} = x^2$  (sure, we could impose another condition) we have  $\phi(x) = x^2$  and then  $u = x^2e^{-t}$ .

*Example 2.1.6.* Consider  $u_t + xu_x = -u^2$ . Then  $\frac{dt}{1} = \frac{dx}{x} = -\frac{du}{u^2}$ . Solving the first equation we get integral curves  $x = Ce^t$ . Now we have

$$-\frac{du}{u^2} = dt \implies u^{-1} = t + D \implies u = (t + \phi(xe^{-t}))^{-1}.$$

which is a general solution of this equation.

Imposing initial condition  $u|_{t=0} = -1$  we get  $\phi = -1$  and then  $u = (t - 1)^{-1}$ . This solution “blows up” as  $t = 1$  (no surprise, we got it, solving *non-linear* ODE).

## 2.1.6 Quasilinear equations

**Definition 2.1.3.** If  $a$  and/or  $b$  depend on  $u$  this is *quasilinear* equation.

For such equations integral curves depend on the solution which can lead to breaking of solution. Indeed, while equations (2.1.7)

$$\frac{dt}{a} = \frac{dx}{b} = \frac{du}{f}.$$

define curves in 3-dimensional space of  $(t, x, u)$ , which do not intersect, their projections on  $(t, x)$ -plane can intersect and then  $u$  becomes a multivalued function, which is not allowed.

*Example 2.1.7.* Consider Burgers equation  $u_t + uu_x = 0$  (which is an extremely simplified model of gas dynamics). We have  $\frac{dt}{1} = \frac{dx}{u} = \frac{du}{0}$  and therefore  $u = \text{const}$  along integral curves and therefore integral curves are  $x - ut = C$ .

Consider initial problem  $u(x, 0) = g(x)$ . We take initial point  $(y, 0)$ , find here  $u = g(y)$ , then  $x - g(y)t = y$  (because  $x = y + ut$  and  $u$  is constant along integral curves) and we get  $u = g(y)$  where  $y = y(x, t)$  is a solution of equation  $x = g(y)t + y$ .

The trouble is that by implicit function theorem we can define  $y$  for all  $x$  only if  $\frac{\partial}{\partial y}(y + g(y)t)$  does not vanish. So,

$$g'(y)t + 1 \neq 0. \tag{2.1.8}$$

This is possible for all  $t > 0$  if and only if  $g'(y) \geq 0$  i.e.  $f$  is a monotone non-decreasing function.

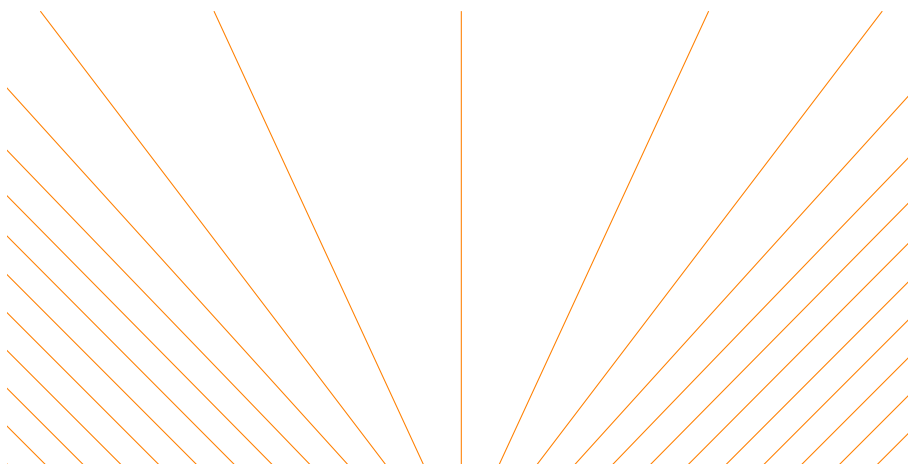

Figure 2.1: Integral lines for Burgers equation if  $f(x) = \tanh(x)$ .

Equivalently,  $u$  is defined as an implicit function by

$$u = g(x - ut). \quad (2.1.9)$$

Then the implicit function theorem could be applied iff

$$\frac{\partial}{\partial u}(u - g(x - ut)) = 1 + g'(x - ut)t \neq 0,$$

which leads us to the previous conclusion.

So, *classical solution* breaks for some  $t > 0$  if  $g$  is not a monotone non-decreasing function. A proper understanding of the *global solution* for such equation goes well beyond our course. Some insight is provided by the analysis in Section 12.1

*Example 2.1.8.* Traffic flow is considered in Appendix 2.1.A.

### 2.1.7 IBVP

Consider IBVP (initial-boundary value problem) for constant coefficient equation

$$\begin{cases} u_t + cu_x = 0, & x > 0, t > 0, \\ u|_{t=0} = f(x) & x > 0. \end{cases} \quad (2.1.10)$$

The general solution is  $u = \phi(x - ct)$  and plugging into initial data we get  $\phi(x) = f(x)$  (as  $x > 0$ ).

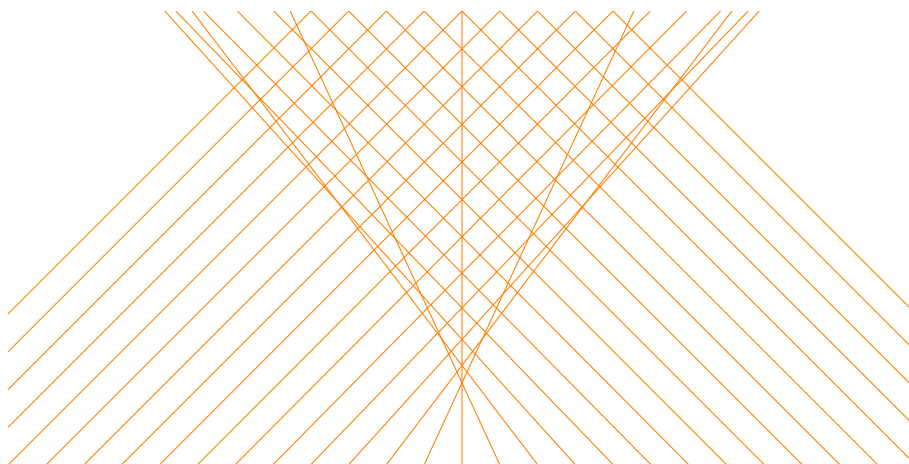
Figure 2.2: Integral lines for Burgers equation if  $f(x) = -\tanh(x)$ .

So,  $u(x, t) = f(x - ct)$ . Done!—Not so fast:  $f$  is defined only for  $x > 0$  so  $u$  is defined for  $x - ct > 0$  (or  $x > ct$ ). It covers the whole quadrant if  $c \leq 0$  (so waves run to the left) and only in this case we are done.

On the other hand, if  $c > 0$  (waves run to the right)  $u$  is not defined as  $x < ct$  and to define it here we need a *boundary condition* at  $x = 0$ .

So we get IBVP (initial-boundary value problem)

$$\begin{cases} u_t + cu_x = 0, & x > 0, t > 0, \\ u|_{t=0} = f(x) & x > 0, \\ u|_{x=0} = g(t) & t > 0. \end{cases} \quad (2.1.11)$$

Then we get  $\phi(-ct) = g(t)$  as  $t > 0$  which implies  $\phi(x) = g(-\frac{1}{c}x)$  as  $x < 0$  and then  $u(x, t) = g(-\frac{1}{c}(x - ct)) = g(t - \frac{1}{c}x)$  as  $x < ct$ .

So solution is

$$u = \begin{cases} f(x - ct) & x > ct, \\ g(t - \frac{1}{c}x) & x < ct. \end{cases} \quad (2.1.12)$$

*Remark 2.1.2.* Unless  $f(0) = g(0)$  this solution is discontinuous as  $x = ct$ . Therefore it is not a classical solution—derivatives do not exist. However it is still a *weak solution* (see Section 11.4) and *solution in the sense of distributions* (see Section 11.1).

### 2.1.A Derivation of a PDE describing traffic flow

The purpose of this discussion is to derive a toy-model PDE that describes a congested one-dimensional highway (in one direction). Let

- (a)  $\rho(x, t)$  denote the *traffic density*: the number of cars per kilometre at time  $t$  located at position  $x$ ;
- (b)  $q(x, t)$  denote the *traffic flow*: the number of cars per hour passing a fixed place  $x$  at time  $t$ ;
- (c)  $N(t, a, b)$  denote the number of cars between position  $x = a$  and  $x = b$  at time  $t$ .

It is directly implied by definition of  $\rho(x, t)$  is

$$N(t, a, b) = \int_a^b \rho(t, x) dx. \quad (2.1.A.1)$$

By definition of  $q$  and conservation of cars we have:

$$\begin{aligned} \frac{\partial N}{\partial t}(t, a, b) &= \lim_{h \rightarrow 0} \frac{N(t+h, a, b) - N(t, a, b)}{h} \\ &= \lim_{h \rightarrow 0} \frac{h(q(t, a) - q(t, b))}{h} = q(t, a) - q(t, b). \end{aligned} \quad (2.1.A.2)$$

Differentiating (2.1.A.1) with respect to  $t$

$$\frac{\partial N}{\partial t} = \int_a^b \rho_t(t, x) dx$$

and making it equal to (2.1.A.2) we get the integral form of “conservation of cars”:

$$\int_a^b \rho_t(t, x) dx = q(t, a) - q(t, b).$$

Since  $a$  and  $b$  are arbitrary, it implies that  $\rho_t = -q_x$ . The PDE

$$\rho_t + q_x = 0 \quad (2.1.A.3)$$

is conservation of cars equation.

After equation (2.1.A.3) or more general equation

$$\rho_t + \rho_x = f(x, t) \quad (2.1.A.4)$$

(where  $f = f_{in} - f_{out}$ ,  $f_{in}dxdt$  and  $f_{out}dxdt$  are numbers of cars entering/exiting highway for time  $dt$  at the segment of the length  $dx$ ) has been derived we need to connect  $\rho$  and  $q$ .

The simplest is  $q = c\rho$  with a constant  $c$ : all cars are moving with the same speed  $c$ . Then (2.1.A.3) becomes

$$\rho_t + c\rho_x = 0. \quad (2.1.A.5)$$

However more realistic would be  $c = c(\rho)$  being monotone decreasing function of  $\rho$  with  $c(0) = c_0$  (speed on empty highway) and  $c(\bar{\rho}) = 0$  where  $\bar{\rho}$  is a density where movement is impossible.

Assume that  $q(\rho) = c(\rho)\rho$  has a single maximum at  $\rho^*$ . Then

$$\rho_t + v\rho_x = 0. \quad (2.1.A.6)$$

with

$$v = v(\rho) = q'(\rho) = c(\rho) + c'(\rho)\rho \quad (2.1.A.7)$$

where  $'$  is a derivative with respect to  $\rho$ . Therefore  $\rho$  remains constant along *integral line*  $x - v(\rho)t = \text{const}$ .

$v = v(\rho)$  is the *phase velocity*, namely the velocity, with which point where density equals given density  $\rho$ , is moving. Here  $v(\rho) < c(\rho)$  (because  $c'(\rho) < 0$ ), so phase velocity is less than the *group velocity*  $c(\rho)$ , which means the velocity of the cars (simply cars may join the congestion from behind and leave it from its front). Further,  $v(\rho) > 0$  as  $\rho < \rho^*$  and  $v(\rho) < 0$  as  $\rho > \rho^*$ ; in the latter case the congestion moves backward: the jam grows faster than it moves.

Also the integral lines may intersect (loose and faster moving congestion catches up with dense and slower congestion). When it happens  $\rho$  becomes discontinuous, (2.1.A.3) still holds but (2.1.A.6) fails (it is no more equivalent to (2.1.A.3)) and the theory becomes really complicated.

*Remark 2.1.A.3.* (a) The notions of *phase velocity* and *group velocity* are important in study of waves, either nonlinear waves as in this case, but also *multidimensional linear waves* and *dispersive waves*.

(b) In the toy-model of gas dynamics  $c(\rho) = \rho$ , or more general  $c'(\rho) > 0$  and  $v(\rho) > c(\rho)$ .

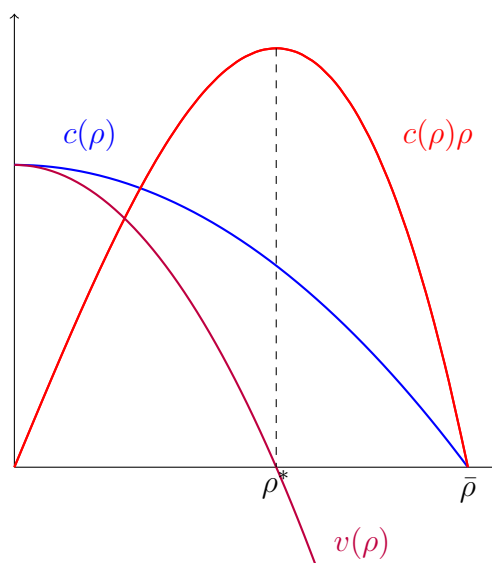

### Problems to Section 2.1

*Problem 1.* (a) Draw characteristics and find the general solution to each of the following equations

$$2u_t + 3u_x = 0;$$

$$u_t + tu_x = 0;$$

$$u_t - tu_x = 0;$$

$$u_t + t^2u_x = 0;$$

$$u_t + xu_x = 0;$$

$$u_t + txu_x = 0;$$

$$u_t + x^2u_x = 0;$$

$$u_t + (x^2 + 1)u_x = 0;$$

$$u_t + (t^2 + 1)u_x = 0;$$

$$(x + 1)u_t + u_x = 0;$$

$$(x + 1)^2u_t + u_x = 0;$$

$$(x^2 + 1)u_t + u_x = 0;$$

$$(x^2 - 1)u_t + u_x = 0.$$

(b) Consider IVP problem  $u|_{t=0} = f(x)$  as  $-\infty < x < \infty$ ; does solution always exist? If not, what conditions should satisfy  $f(x)$ ? Consider separately  $t > 0$  and  $t < 0$ .

(c) Where this solution is uniquely determined? Consider separately  $t > 0$  and  $t < 0$ .

(d) Consider this equation in  $\{t > 0, x > 0\}$  with the initial condition  $u|_{t=0} = f(x)$  as  $x > 0$ ; where this solution defined? Is it defined everywhere

in  $\{t > 0, x > 0\}$  or do we need to impose condition at  $x = 0$ ? In the latter case impose condition  $u|_{x=0} = g(t)$  ( $t > 0$ ) and solve this IVBP;

(e) Consider this equation in  $\{t > 0, x < 0\}$  with the initial condition  $u|_{t=0} = f(x)$  as  $x < 0$ ; where this solution defined? Is it defined everywhere in  $\{t > 0, x < 0\}$  or do we need to impose condition at  $x = 0$ ? In the latter case impose condition  $u|_{x=0} = g(t)$  ( $t > 0$ ) and solve this IVBP;

(f) Consider problems (d) as  $t < 0$ ;

(g) Consider problems (e) as  $t < 0$ ;

*Problem 2.* (a) Find the general solution to each of the following equations

$$\begin{aligned}xu_x + yu_y &= 0, \\xu_x - yu_y &= 0\end{aligned}$$

in  $\{(x, y) \neq (0, 0)\}$ ; when this solution is continuous at  $(0, 0)$ ? Explain the difference between these two cases;

(b) Find the general solution to each of the following equations

$$\begin{aligned}yu_x + xu_y &= 0, \\yu_x - xu_y &= 0\end{aligned}$$

in  $\{(x, y) \neq (0, 0)\}$ ; when this solution is continuous at  $(0, 0)$ ? Explain the difference between these two cases;

*Problem 3.* In the same way consider equations

$$\begin{aligned}(x^2 + 1)yu_x + (y^2 + 1)xu_y &= 0; \\(x^2 + 1)yu_x - (y^2 + 1)xu_y &= 0.\end{aligned}$$

*Problem 4.* Find the solutions of

$$\begin{cases} u_x + 3u_y = xy, \\ u|_{x=0} = 0; \end{cases} \quad \begin{cases} u_x + 3u_y = u, \\ u|_{x=0} = y. \end{cases}$$

*Problem 5.* Find the general solutions to each of

$$\begin{aligned}yu_x - xu_y &= x; & yu_x - xu_y &= x^2; \\yu_x + xu_y &= x; & yu_x + xu_y &= x^2.\end{aligned}$$

In one instance solution does not exist. Explain why.



*Problem 6.* Solve IVP

$$\begin{cases} u_t + uu_x = 0, & t > 0; \\ u|_{t=0} = f(x) \end{cases}$$

and describe domain in  $(x, t)$  where this solution is properly defined with one of the following initial data

$$\begin{aligned} f(x) &= \tanh(x); & f(x) &= -\tanh(x); \\ f(x) &= \begin{cases} -1 & x < -a, \\ \frac{x}{a} & -a \leq x \leq a, \\ 1 & x > a; \end{cases} & f(x) &= \begin{cases} 1 & x < -a, \\ -\frac{x}{a} & -a \leq x \leq a, \\ -1 & x > a; \end{cases} \\ f(x) &= \begin{cases} -1 & x < 0, \\ 1 & x > 0; \end{cases} & f(x) &= \sin(x). \\ f(x) &= \begin{cases} \sin(x) & |x| < \pi, \\ 0 & |x| > \pi, \end{cases} & f(x) &= \begin{cases} -\sin(x) & |x| < \pi, \\ 0 & |x| > \pi, \end{cases} \end{aligned}$$

Here  $a > 0$  is a parameter.

*Problem 7.* Find the largest strip

$$\Pi = \{(x, t): -\infty < x < \infty, T_1 < t < T_2\}$$

with  $-\infty \leq T_1 \leq 0 \leq T_2 \leq \infty$  such that

$$\begin{aligned} u_t + uu_x &= 0 & -\infty < x < \infty, \\ u|_{t=0} &= f(x) \end{aligned}$$

has a smooth solution in  $\Pi$ , where

$$\begin{aligned} f(x) &= 2\sin(2x); & f(x) &= -\frac{1}{2}\arctan(x); \\ f(x) &= 2\tanh(x); & f(x) &= \sinh(x). \end{aligned}$$

*Problem 8.* Find largest  $A \geq 0$  such that

$$\begin{aligned} u_t + uu_x &= -u & -\infty < x < \infty, \\ u|_{t=0} &= Af(x) \end{aligned}$$

has a smooth solution in  $\{(x, t): -\infty < x < \infty, T_1 < t < T_2\}$ , where

$$\begin{aligned} f(x) &= \cos(2x), & T_1 &= 0, & T_2 &= \infty; \\ f(x) &= \tanh(x), & T_1 &= -\infty, & T_2 &= \infty; \\ f(x) &= -\arctan(4x), & T_1 &= -\infty, & T_2 &= \infty; \\ f(x) &= \sinh(3x), & T_1 &= -\infty, & T_2 &= \infty. \end{aligned}$$

## 2.2 Multidimensional equations

### 2.2.1 Multidimensional linear and semilinear equations

*Remark 2.2.1.* Multidimensional equations (from linear to semilinear)

$$au_t + \sum_{j=1}^n b_j u_{x_j} = f(x_1, \dots, x_n, t, u) \quad (2.2.1)$$

and even quasilinear (with  $a = a(x_1, \dots, x_n, t, u)$  and  $b_j = b_j(x_1, \dots, x_n, t, u)$ ) could be solved by the same methods.

*Example 2.2.1.*  $a = 1$ ,  $b_j = \text{const}$  and  $f = 0$  the general solution of (2.2.1) is  $u = \phi(x_1 - b_1 t, \dots, x_n - b_n t)$  where  $\phi$  is an arbitrary function of  $n$  variables.

*Example 2.2.2.* Find the general solution of

$$u_t + 2tu_x + xu_y = 0.$$

Finding integral curves

$$\frac{dt}{1} = \frac{dx}{2t} = \frac{dy}{x} = \frac{du}{0}$$

from the first equation we conclude that  $x - t^2 = C$  and then  $dy = xdt = (C + t^2)dt \implies y - Ct - \frac{t^3}{3} = D$ . Then  $D = y - (x - t^2)t - \frac{t^3}{3} = y - xt + \frac{2t^3}{3}$ . Therefore

$$u(x, y, t) = \phi\left(x - t^2, y - xt + \frac{2t^3}{3}\right)$$

is the general solution.

*Example 2.2.3.* Find the general solution of

$$u_t + 2tu_x + xu_y = 12xtu.$$

Finding integral curves

$$\frac{dt}{1} = \frac{dx}{2t} = \frac{dy}{x} = \frac{du}{12xtu}$$

from Example 2.2.2 we know that  $x = t^2 + C$  and  $y = Ct + \frac{t^3}{3}$ . Then

$$\begin{aligned} \frac{du}{u} &= 12xt dt = (4t^3 + 12Ct)dt \implies \ln(u) = (t^4 + 6Ct^2) + \ln(E) \\ &\implies u = E \exp(t^4 + 6Ct^2) = \exp(-5t^4 + 6xt^2)E \\ &\implies u = \exp(-5t^4 + 6xt^2)\phi(x - t^2, y - xt + \frac{2t^3}{3}) \end{aligned}$$

is the general solution.

## 2.2.2 Multidimensional non-linear equations (optional)

We consider fully non-linear multidimensional equation in  $\mathbb{R}^n$

$$F(x, u, \nabla u) = 0 \quad (2.2.2)$$

(we prefer such notations here) with  $x = (x_1, \dots, x_n)$ ,  $\nabla u = (u_{x_1}, \dots, u_{x_n})$  and the *initial condition*

$$u|_{\Sigma} = g \quad (2.2.3)$$

where  $\Sigma$  is a hypersurface. If  $F = u_{x_1} - f(x, u, u_{x_2}, \dots, u_{x_n})$  and  $\Sigma = \{x_1 = 0\}$  then such problem has a *local solution* and it is unique. However we consider a general form under assumption

$$\sum_{1 \leq j \leq n} F_{p_j}(x, u, p) \Big|_{p=\nabla u} \nu_j \neq 0 \quad (2.2.4)$$

where  $\nu = \nu(x) = (\nu_1, \dots, \nu_n)$  is a normal to  $\Sigma$  at point  $x$ .

Consider  $p = \nabla u$  and consider a *characteristic curve* in  $x$ -space ( $n$ -dimensional)  $\frac{dx_j}{dt} = F_{p_j}$  which is exactly (2.2.7) below. Then by the chain rule

$$\frac{dp_j}{dt} = \sum_k p_{j,x_k} \frac{dx_k}{dt} = \sum_k u_{x_j x_k} F_{p_k} \quad (2.2.5)$$

and

$$\frac{du}{dt} = \sum_k u_{x_k} \frac{dx_k}{dt} = \sum_k p_k F_{p_k}. \quad (2.2.6)$$

The last equation is exactly (2.2.9) below. To deal with (2.2.5) we differentiate (2.2.2) by  $x_j$ ; by the chain rule we get

$$0 = \partial_{x_j}(F(x, u, \nabla u)) = F_{x_j} + F_u u_{x_j} + \sum_k F_{p_k} p_{k,x_j} = F_{x_j} + F_u u_{x_j} + \sum_k F_{p_k} u_{x_k x_j}$$

and therefore the r.h.e. in (2.2.5) is equal to  $-F_{x_j} - F_u u_{x_j}$  and we arrive exactly to equation (2.2.8) below.

So we have a system defining a *characteristic trajectory* which lives in  $(2n + 1)$ -dimensional space:

$$\frac{dx_j}{dt} = F_{p_j}, \quad (2.2.7)$$

$$\frac{dp_j}{dt} = -F_{x_j} - F_u p_j, \quad (2.2.8)$$

$$\frac{du}{dt} = \sum_{1 \leq j \leq n} F_{p_j} p_j. \quad (2.2.9)$$

*Characteristic curve* is  $n$ -dimensional  $x$ -projection of the *characteristic trajectory*. Condition (2.2.4) simply means that characteristic curve is *transversal* (i. e. is not tangent) to  $\Sigma$ .

Therefore, to solve (2.2.2)-(2.2.3) we need to

- (a) Find  $\nabla_{\Sigma} u = \nabla_{\Sigma} g$  at  $\Sigma$  (i.e. we find gradient of  $u$  along  $\Sigma$ ; if  $\Sigma = \{x_1 = 0\}$ , then we just calculate  $u_{x_2}, \dots, u_{x_n}$ ).
- (b) From (2.2.2) we find the remaining normal component of  $\nabla u$  at  $\Sigma$ ; so we have  $(n - 1)$ -dimensional surface  $\Sigma^* = \{(x, u, \nabla u), x \in \Sigma\}$  in  $(2n + 1)$ -dimensional space.
- (c) From each point of  $\Sigma^*$  we issue a characteristic trajectory described by (2.2.7)-(2.2.9). These trajectories together form  $n$ -dimensional hypersurface  $\Lambda$  in  $(2n + 1)$ -dimensional space.

(d) Locally (near  $t = 0$ ) this surface  $\Lambda$  has one-to-one  $x$ -projection and we can restore  $u = u(x)$  (and  $\nabla u = p(x)$ ).

*Remark 2.2.2.* (a) However this property 4 is just local. Globally projection can stop be one-to-one, and points where it is not one-to-one even locally (that means, it is not one to one even in the small vicinity of such point) have a special role. Their projection to  $x$ -space are called *caustics*.

(b) We have not proved directly that this construction always gives us a solution but if we know that solution exists then our arguments imply that it is unique and could be found this way. Existence could be proven either directly or by some other arguments.

*Remark 2.2.3.* (a) Important for application case is when  $F$  does not depend on  $u$  (only on  $x, p = \nabla u$ ) and (2.2.7)–(2.2.9) become highly symmetrical with respect to  $(x, p)$ :

$$\frac{dx_j}{dt} = F_{p_j}, \quad (2.2.10)$$

$$\frac{dp_j}{dt} = -F_{x_j}, \quad (2.2.11)$$

$$\frac{du}{dt} = \sum_{1 \leq j \leq n} p_j F_{p_j}. \quad (2.2.12)$$

This is so called *Hamiltonian system* with the *Hamiltonian*  $F(x, p)$ .

(b) In this case we can drop  $u$  from the consideration and consider only (2.2.10)–(2.2.11) describing  $(x, p)$ -projections of  $\Sigma^*$  and  $\Lambda$ , finding  $u$  afterwards from (2.2.12). Typical example: *Hamiltonian mechanics*, with the *generalized coordinates*  $x$  and *generalized momenta*  $p$ .

## Problems to Section 2.2

*Problem 1.* (a) Find the general solution to each of the following equations

$$\begin{aligned} u_t + 3u_x - 2u_y &= 0; & u_t + xu_x + yu_y &= 0; \\ u_t + xu_x - yu_y &= 0; & u_t + yu_x + xu_y &= 0; \\ u_t + yu_x - xu_y &= 0. \end{aligned}$$

(b) Solve IVP  $u(x, y, 0) = f(x, y)$ .

*Problem 2.* (a)

$$\begin{aligned} u_t + 3u_x - 2u_y &= x; & u_t + xu_x + yu_y &= x; \\ u_t + xu_x - yu_y &= x; & u_t + yu_x + xu_y &= x; \\ u_t + yu_x - xu_y &= x. \end{aligned}$$

(b) Solve IVP  $u(x, y, 0) = 0$ .

*Problem 3.* (a) Find the general solution to each of the following equations

$$\begin{aligned} u_t + 3u_x - 2u_y &= u; & u_t + xu_x + yu_y &= u; \\ u_t + xu_x - yu_y &= u; & u_t + yu_x + xu_y &= u; \\ u_t + yu_x - xu_y &= u; & u_t + 3u_x - 2u_y &= xyu. \end{aligned}$$

(b) Solve IVP  $u(x, y, 0) = f(x, y)$ .

## 2.3 Homogeneous 1D wave equation

### 2.3.1 Physical examples

Consider equation

$$u_{tt} - c^2 u_{xx} = 0. \quad (2.3.1)$$

*Remark 2.3.1.* (a) As we mentioned in Subsection 1.4.1 this equation describes a lot of things.

(b)  $c$  has a dimension of the speed. In the example above  $c$  is a *speed of sound*.

*Example 2.3.1.* (a) This equation describes oscillations of the string Example 1.4.1.

(b) It also describes 1-dimensional gas oscillations (see Example 1.4.3).

(c) Further, this equation with  $c = c_{\parallel}$  also describes *compression-rarefaction waves* in the elastic 1-dimensional media. Then  $u(x, t)$  is displacement along  $x$ .

(d) And also this equation with  $c = c_{\perp} < c_{\parallel}$  also describes *sheer waves* in the elastic 1-dimensional media. Then  $u(x, t)$  is displacement in the direction, perpendicular to  $x$ .

### 2.3.2 General solution

Let us rewrite formally equation (2.3.1) as

$$(\partial_t^2 - c^2 \partial_x^2)u = (\partial_t - c\partial_x)(\partial_t + c\partial_x)u = 0. \quad (2.3.2)$$

Denoting  $v = (\partial_t + c\partial_x)u = u_t + cu_x$  and  $w = (\partial_t - c\partial_x)u = u_t - cu_x$  we have

$$v_t - cv_x = 0, \quad (2.3.3)$$

$$w_t + cw_x = 0. \quad (2.3.4)$$

But from Section 2.1 we know how to solve these equations

$$v = 2c\phi'(x + ct), \quad (2.3.5)$$

$$w = -2c\psi'(x - ct) \quad (2.3.6)$$

where  $\phi'$  and  $\psi'$  are arbitrary functions. We find convenient to have factors  $2c$  and  $-2c$  and to denote by  $\phi$  and  $\psi$  their primitives (a.k.a. indefinite integrals).

Recalling definitions of  $v$  and  $w$  we have

$$u_t + cu_x = 2c\phi'(x + ct),$$

$$u_t - cu_x = -2c\psi'(x - ct).$$

Observe that the right-hand side of (2.3.5) equals to  $(\partial_t + c\partial_x)\phi(x + ct)$  and therefore  $(\partial_t + c\partial_x)(u - \phi(x + ct)) = 0$ . Then  $u - \phi(x + ct)$  must be a function of  $x - ct$ :  $u - \phi(x + ct) = \chi(x - ct)$  and plugging into (2.3.6) we conclude that  $\chi = \psi$  (up to a constant, but both  $\phi$  and  $\psi$  are defined up to some constants).

Therefore

$$u = \phi(x + ct) + \psi(x - ct) \quad (2.3.7)$$

is a *general solution* to (2.3.1). This solution is a superposition of two waves  $u_1 = \phi(x + ct)$  and  $u_2 = \psi(x - ct)$  running to the left and to the right respectively with the speed  $c$ . So  $c$  is a *propagation speed*.

*Remark 2.3.2.* Adding constant  $C$  to  $\phi$  and  $-C$  to  $\psi$  we get the same solution  $u$ . However it is the only arbitrariness.

[Visual examples \(animation\)](#)

### 2.3.3 Cauchy problem

Let us consider IVP (*initial-value problem*, aka *Cauchy problem*) for (2.3.1):

$$u_{tt} - c^2 u_{xx} = 0, \quad (2.3.8)$$

$$u|_{t=0} = g(x), \quad u_t|_{t=0} = h(x). \quad (2.3.9)$$

Plugging (2.3.7)  $u = \phi(x + ct) + \psi(x - ct)$  into initial conditions we have

$$\phi(x) + \psi(x) = g(x), \quad (2.3.10)$$

$$c\phi'(x) - c\psi'(x) = h(x) \implies \phi(x) - \psi(x) = \frac{1}{c} \int^x h(y) dy. \quad (2.3.11)$$

Then

$$\phi(x) = \frac{1}{2}g(x) + \frac{1}{2c} \int^x h(y) dy, \quad (2.3.12)$$

$$\psi(x) = \frac{1}{2}g(x) - \frac{1}{2c} \int^x h(y) dy. \quad (2.3.13)$$

Plugging into (2.3.7)

$$u(x, t) = \frac{1}{2}g(x + ct) + \frac{1}{2c} \int_{x-ct}^{x+ct} h(y) dy + \frac{1}{2}g(x - ct) - \frac{1}{2c} \int^{x-ct} h(y) dy$$

we get *D'Alembert formula*

$$u(x, t) = \frac{1}{2}[g(x + ct) + g(x - ct)] + \frac{1}{2c} \int_{x-ct}^{x+ct} h(y) dy. \quad (2.3.14)$$

*Remark 2.3.3.* Later we generalize it to the case of inhomogeneous equation (with the right-hand expression  $f(x, t)$  in (2.3.8)).

### 2.3.1 Running wave solutions

Running wave solutions

We know that *string equation*

$$u_{tt} - c^2 u_{xx} = 0$$

has *running wave solutions*

$$u(x, t) = f(x - ct) \quad (2.3.A.1)$$



with an arbitrary function  $f(\cdot)$ .

In some equations arising in applications such solutions would be interesting. F.e. consider [Korteweg–De Vries equation](#) from the theory of 1D–water waves:

$$u_t + u_{xxx} - 6uu_x = 0 \quad (2.3.A.2)$$

with the second term describing dispersion.

Plugging (2.3.A.1) into (2.3.A.2) we get

$$-cf' + f''' - 6ff' = 0;$$

integrating it we get

$$-cf + f'' - 3f^2 = A$$

where  $A$  is a constant. This is autonomous ODE and to solve it we denote  $z = f'$ ; then

$$z \frac{dz}{df} = f + 3f^2 + A$$

and integrating we get

$$z^2 = f^2 + 2f^3 + Af + B$$

and

$$x = \int \frac{df}{\sqrt{f^2 + 2f^3 + Af + B}}.$$

Taking  $A = 0$  we get

$$u(x, t) = -\frac{1}{2} \cosh^{-2} \left( \frac{\sqrt{c}}{2} (x - ct - a) \right) \quad (2.3.A.3)$$

describing *solitons* (solitary waves). Here  $a$  is arbitrary.

We took  $A = 0$  to get solutions decaying as  $x \rightarrow \pm\infty$ ; otherway we would get periodic solutions.

In contrast to wave equation shape of solutions (that is function  $f$ ) is not arbitrary and different solitons have different speed of propagation  $c$ . Further, due to non-linearity sum of solutions is not a solution.

Theory of this equation and similiary equation was extensively developed in 1970th.

**Problems to Section 2.3**

*Problem 1.* Find the general solutions of

$$\begin{aligned} u_{tt} - u_{xx} &= 0; & u_{tt} - 4u_{xx} &= 0; \\ u_{tt} - 9u_{xx} &= 0; & 4u_{tt} - u_{xx} &= 0; \\ u_{tt} - 9u_{xx} &= 0. \end{aligned}$$

*Problem 2.* Solve IVP

$$\begin{cases} u_{tt} - c^2 u_{xx} = 0, \\ u|_{t=0} = g(x), \quad u_t|_{t=0} = h(x) \end{cases} \quad (2.C.1)$$

with

$$g(x) = \begin{cases} 0 & x < 0, \\ 1 & x \geq 0, \end{cases} \quad h(x) = 0;$$

$$g(x) = \begin{cases} 1 & |x| < 1, \\ 0 & |x| \geq 1, \end{cases} \quad h(x) = 0;$$

$$g(x) = \begin{cases} 1 - |x| & |x| < 1, \\ 0 & |x| \geq 1, \end{cases} \quad h(x) = 0;$$

$$g(x) = \begin{cases} 1 - x^2 & |x| < 1, \\ 0 & |x| \geq 1, \end{cases} \quad h(x) = 0;$$

$$g(x) = \begin{cases} \cos(x) & |x| < \pi/2, \\ 0 & |x| \geq \pi/2, \end{cases} \quad h(x) = 0;$$

$$g(x) = \begin{cases} \cos^2(x) & |x| < \pi/2, \\ 0 & |x| \geq \pi/2, \end{cases} \quad h(x) = 0;$$

$$g(x) = \begin{cases} \sin(x) & |x| < \pi, \\ 0 & |x| \geq \pi, \end{cases} \quad h(x) = 0;$$

$$g(x) = \begin{cases} \sin^2(x) & |x| < \pi, \\ 0 & |x| \geq \pi, \end{cases} \quad h(x) = 0;$$

$$g(x) = 0, \quad h(x) = \begin{cases} 0 & x < 0, \\ 1 & x \geq 0; \end{cases}$$

$$g(x) = 0, \quad h(x) = \begin{cases} 1 - x^2 & |x| < 1, \\ 0 & |x| \geq 1; \end{cases}$$

$$g(x) = 0, \quad h(x) = \begin{cases} 1 & |x| < 1, \\ 0 & |x| \geq 1; \end{cases}$$

$$g(x) = 0, \quad h(x) = \begin{cases} \cos(x) & |x| < \pi/2, \\ 0 & |x| \geq \pi/2; \end{cases}$$

$$g(x) = 0, \quad h(x) = \begin{cases} \sin(x) & |x| < \pi, \\ 0 & |x| \geq \pi. \end{cases}$$

*Problem 3.* Find solution  $u = u(x, t)$  and describe domain, where it is uniquely defined

$$\begin{aligned} u_{tt} - u_{xx} &= 0; \\ u|_{t=x^2/2} &= x^3; \\ u_t|_{t=x^2/2} &= 2x. \end{aligned}$$

*Problem 4.* (a) Prove that if  $u$  solves the problem

$$\begin{cases} u_{tt} - c^2 u_{xx} = 0 & -\infty < x < \infty, \\ u|_{t=0} = g(x), \\ u_t|_{t=0} = 0, \end{cases} \quad (2.C.2)$$

then  $v = \int_0^t u(x, t') dt'$  solves

$$\begin{cases} v_{tt} - c^2 v_{xx} = 0 & -\infty < x < \infty, \\ v|_{t=0} = 0, \\ v_t|_{t=0} = g(x). \end{cases} \quad (2.C.3)$$

(b) Also prove that if  $v$  solves (2.C.3) then  $u = v_t$  solves (2.C.2).

(c) From formula

$$u(x, t) = \frac{1}{2}(g(x + ct) + g(x - ct)) \quad (2.C.4)$$

for the solution of (2.C.2) derive

$$v(x, t) = \frac{1}{2c} \int_{x-ct}^{x+ct} g(x') dx' \quad (2.C.5)$$

for the solution of (2.C.3).

(d) Conversely, from (2.C.5) for the solution of (2.C.3) derive (2.C.4) for the solution of (2.C.2).

*Problem 5.* Find solution to equation

$$Au_{tt} + 2Bu_{tx} + Cu_{xx} = 0 \quad (2.C.6)$$

as

$$u = f(x - c + 1t) + g(x - c + 2t) \quad (2.C.7)$$

with arbitrary  $f, g$  and real  $c + 1 < c_2$ .

(a) What equation should satisfy  $c_1$  and  $c_2$ ?

(b) When this equation has such roots?

*Problem 6.* A spherical wave is a solution of the three-dimensional wave equation of the form  $u(r, t)$ , where  $r$  is the distance to the origin (the spherical coordinate). The wave equation takes the form

$$u_{tt} = c^2 \left( u_{rr} + \frac{2}{r} u_r \right) \quad (\text{spherical wave equation}). \quad (2.C.8)$$

(a) Change variables  $v = ru$  to get the equation for  $v$ :  $v_{tt} = c^2 v_{rr}$ .

(b) Solve for  $v$  using

$$v = f(r + ct) + g(r - ct) \quad (2.C.9)$$

and thereby solve the spherical wave equation.

(c) Use

$$v(r, t) = \frac{1}{2}[\phi(r + ct) + \phi(r - ct)] + \frac{1}{2c} \int_{r-ct}^{r+ct} \psi(s) ds \quad (2.C.10)$$

with  $\phi(r) = v(r, 0)$ ,  $\psi(r) = v + t(r, 0)$  to solve it with initial conditions  $u(r, 0) = \Phi(r)$ ,  $u + t(r, 0) = \Psi(r)$ .

(d) Find the general form of solution  $u$  to (2.C.8) which is continuous as  $r = 0$ .

*Problem 7.* Find formula for solution of the *Goursat problem*

$$u_{tt} - c^2 u_{xx} = 0, \quad x > c|t|; \quad (2.C.11)$$

$$u|_{x=-ct} = g(t), \quad t < 0; \quad (2.C.12)$$

$$u|_{x=ct} = h(t), \quad t > 0. \quad (2.C.13)$$

as long as  $g(0) = h(0)$ .

*Problem 8.* Find solution  $u = u(x, t)$  and describe domain, where it is uniquely defined

$$u + tt - u + xx = 0, \quad (2.C.14)$$

$$u|_{t=0} = x^2/2 = x^3, \quad |x| \leq 1, \quad (2.C.15)$$

$$u + t|_{x=0} = x^2/2 = 2x \quad |x| \leq 1. \quad (2.C.16)$$

Explain, why we imposed restriction  $|x| \leq 1$ ?

*Problem 9.* Often solution in the form of *travelling wave*  $u = \phi(x - vt)$  is sought for more general equations. Here we are interested in the bounded solutions, especially in those with  $\phi(x)$  either tending to 0 as  $|x| \rightarrow \infty$  (solitons) or periodic (kinks). Plugging such solution to equation we get ODE for function  $\phi$ , which could be either solved or at least explored. Sure we are not interested in the trivial solution which is identically equal to 0.

(a) Find such solutions for each of the following equations

$$u + tt - c^2 u + xx + m^2 u = 0; \quad (2.C.17)$$

$$u + tt - c^2 u + xx - m^2 u = 0; \quad (2.C.18)$$

the former is *Klein-Gordon equation*. Describe all possible velocities  $v$ .

(b) Find such solutions for each of the following equations

$$u_t - Ku_{xxx} = 0; \quad (2.C.19)$$

$$u_t - iKu_{xx} = 0; \quad (2.C.20)$$

$$u_{tt} + Ku_{xxxx} = 0. \quad (2.C.21)$$

*Problem 10.* Look for solutions in the form of travelling wave for sine-Gordon equation

$$u_{tt} - c^2u_{xx} + \sin(u) = 0. \quad (2.C.22)$$

observe that resulting ODE is describing *mathematical pendulum* which could be explored. Describe all possible velocities  $v$ .

*Problem 11.* Look for solutions in the form of travelling wave for each of the following equations

$$u_{tt} - u_{xx} + u - 2u^3 = 0; \quad (2.C.23)$$

$$u_{tt} - u_{xx} - u + 2u^3 = 0; \quad (2.C.24)$$

(a) Describe such solutions (they are called kinks). Describe all possible velocities  $v$ .

(b) Find solitons. Describe all possible velocities  $v$ .

*Problem 12.* For a solution  $u(x, t)$  of the wave equation  $u_{tt} = c^2u_{xx}$ , the *energy density* is defined as  $e = \frac{1}{2}(u_t^2 + c^2u_x^2)$  and the *momentum density* as  $p = cu_tu_x$ .

(a) Show that

$$\frac{\partial e}{\partial t} = c \frac{\partial p}{\partial x} \quad \text{and} \quad \frac{\partial p}{\partial t} = c \frac{\partial e}{\partial x}. \quad (2.C.25)$$

(b) Show that both  $e(x, t)$  and  $p(x, t)$  also satisfy the same wave equation.

*Problem 13.* (a) Consider wave equation  $u_{tt} - u_{xx} = 0$  in the rectangle  $0 < x < a$ ,  $0 < t < b$  and prove that if  $a$  and  $b$  are not *commensurable* (i.e.  $a : b$  is not rational) then Dirichlet problem  $u|_{t=0} = u|_{t=b} = u|_{x=0} = u|_{x=a} = 0$  has only trivial solution.

(b) On the other hand, prove that if  $a$  and  $b$  are *commensurable* then there exists a nontrivial solution  $u = \sin(px/a) \sin(qt/b)$ .

*Problem 14.* Generalize Problem 6: A spherical wave is a solution of the  $n$ -dimensional wave equation of the form  $u(r, t)$ , where  $r$  is the distance to the origin (the spherical coordinate). The wave equation takes the form

$$u_{tt} = c^2 \left( u_{rr} + \frac{n-1}{r} u_r \right) \quad (\text{spherical wave equation}) \quad (2.C.26)$$

(a) Show that if  $u$  satisfies (2.C.26), then  $r^{-1} \partial_r u(r, t)$  also satisfies (2.C.26) but with  $n$  replaced by  $n + 2$ .

(b) Using this and Problem 6: write down spherical wave for odd  $n$ .

(c) Describe spherical wave for  $n = 1$ .

*Remark 2.C.4.* For even  $n$  spherical waves do not exist.

## 2.4 1D-Wave equation reloaded: characteristic coordinates

### 2.4.1 Characteristic coordinates

We realize that lines  $x + ct = \text{const}$  and  $x - ct = \text{const}$  play a very special role in our analysis. We call these lines *characteristics*. Let us introduce *characteristic coordinates*

$$\begin{cases} \xi = x + ct, \\ \eta = x - ct. \end{cases} \quad (2.4.1)$$

**Proposition 2.4.1.** *The following equality holds:*

$$u_{tt} - c^2 u_{xx} = -4c^2 u_{\xi\eta}. \quad (2.4.2)$$

*Proof.* From (2.4.1) we see that  $x = \frac{1}{2}(\xi + \eta)$  and  $t = \frac{1}{2c}(\xi - \eta)$  and therefore due to chain rule  $v_\xi = \frac{1}{2}v_x + \frac{1}{2c}v_t$  and  $v_\eta = \frac{1}{2}v_x - \frac{1}{2c}v_t$  and therefore

$$-4c^2 u_{\xi\eta} = -(c\partial_x + \partial_t)(c\partial_x - \partial_t)u = u_{tt} - c^2 u_{xx}.$$

□

Therefore wave equation (2.3.1) becomes in the characteristic coordinates

$$u_{\xi\eta} = 0 \tag{2.4.3}$$

which we rewrite as  $(u_{\xi})_{\eta} = 0 \implies u_{\xi} = \phi'(\xi)$  (really,  $u_{\xi}$  should not depend on  $\eta$  and it is convenient to denote by  $\phi(\xi)$  the primitive of  $u_{\xi}$ ). Then  $(u - \phi(\xi))_{\xi} = 0 \implies u - \phi(\xi) = \psi(\eta)$  (due to the same arguments) and therefore

$$u = \phi(\xi) + \psi(\eta) \tag{2.4.4}$$

is the *general solution* to (2.4.3).

## 2.4.2 Application of characteristic coordinates

*Example 2.4.1.* Consider *Goursat problem* for (2.4.3):

$$\begin{aligned} u_{\xi\eta} &= 0 && \text{as } \xi > 0, \eta > 0 \\ u|_{\eta=0} &= g(\xi) && \text{as } \xi > 0, \\ u|_{\xi=0} &= h(\eta) && \text{as } \eta > 0 \end{aligned}$$

where  $g$  and  $h$  must satisfy *compatibility condition*  $g(0) = h(0)$  (really  $g(0) = u(0, 0) = h(0)$ ).

Then one can see easily that  $u(\xi, \eta) = g(\xi) + h(\eta) - g(0)$  solves Goursat problem. Plugging (2.4.1) into (2.4.4) we get for a general solution to (2.3.1)

$$u = \phi(x + ct) + \psi(x - ct) \tag{2.4.5}$$

which is exactly (2.3.7).

## 2.4.3 D'Alembert formula

So far we achieved nothing new. Consider now IVP:

$$u_{tt} - c^2 u_{xx} = f(x, t), \tag{2.4.6}$$

$$u|_{t=0} = g(x), \tag{2.4.7}$$

$$u_t|_{t=0} = h(x). \tag{2.4.8}$$



It is convenient for us to assume that  $g = h = 0$ . Later we will get rid of this assumption. Rewriting (2.4.6) as

$$\tilde{u}_{\xi\eta} = -\frac{1}{4c^2} \tilde{f}(\xi, \eta)$$

(where  $\tilde{u}$  etc means that we use characteristic coordinates) we get after integration

$$\tilde{u}_\xi = -\frac{1}{4c^2} \int^\eta \tilde{f}(\xi, \eta') d\eta' = -\frac{1}{4c^2} \int_\xi^\eta \tilde{f}(\xi, \eta') d\eta' + \phi'(\xi)$$

with an indefinite integral in the middle.

Note that  $t = 0$  means exactly that  $\xi = \eta$ , but then  $u_\xi = 0$  there. Really,  $u_\xi$  is a linear combination of  $u_t$  and  $u_x$  but both of them are 0 as  $t = 0$ . Therefore  $\phi'(\xi) = 0$  and

$$\tilde{u}_\xi = \frac{1}{4c^2} \int_\eta^\xi \tilde{f}(\xi, \eta') d\eta'$$

where we flipped limits and changed sign.

Integrating with respect to  $\xi$  we arrive to

$$\tilde{u} = \frac{1}{4c^2} \int^\xi \left[ \int_\eta^{\xi'} \tilde{f}(\xi', \eta') d\eta' \right] d\xi' = \frac{1}{4c^2} \int_\eta^\xi \left[ \int_\eta^{\xi'} \tilde{f}(\xi', \eta') d\eta' \right] d\xi' + \psi(\eta)$$

and  $\psi(\eta)$  also must vanish because  $u = 0$  as  $t = 0$  (i.e.  $\xi = \eta$ ). So

$$\tilde{u}(\xi, \eta) = \frac{1}{4c^2} \int_\eta^\xi \left[ \int_\eta^{\xi'} \tilde{f}(\xi', \eta') d\eta' \right] d\xi'. \quad (2.4.9)$$

We got a solution as a *double integral* but we want to write it down as *2-dimensional integral*

$$\tilde{u}(\xi, \eta) = \frac{1}{4c^2} \iint_{\tilde{\Delta}(\xi, \eta)} \tilde{f}(\xi', \eta') d\eta' d\xi'. \quad (2.4.10)$$

But what is  $\tilde{\Delta}$ ? Consider  $\xi > \eta$ . Then  $\xi'$  should run from  $\eta$  to  $\xi$  and for fixed  $\xi'$ ,  $\eta < \xi' < \xi$  eta should run from  $\eta$  to  $\xi'$ . So, we get a triangle bounded by  $\xi' = \eta'$ ,  $\xi' = \xi$  and  $\eta' = \eta$ :

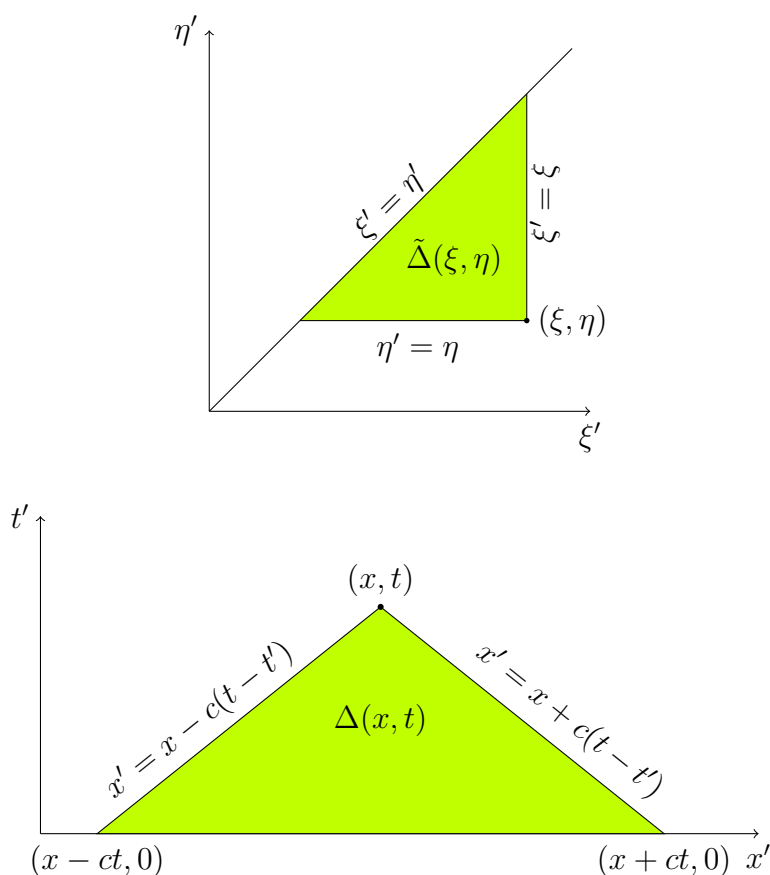

But in coordinates  $(x, t)$  this domain  $\Delta(x, t)$  is bounded by  $t = 0$  and two characteristics passing through  $(x, t)$ :

So, we get

$$u(x, t) = \frac{1}{2c} \iint_{\Delta(x, t)} f(x', t') dx' dt'. \quad (2.4.11)$$

because we need to replace  $d\xi' d\eta'$  by  $|J| dx' dt'$  with *Jacobian*  $J$ .

*Exercise 2.4.1.* Calculate  $J$  and justify factor  $2c$ .

*Remark 2.4.1.* (a) Formula (2.4.11) solves IVP for inhomogeneous wave equation with homogeneous (that means equal 0) initial data, while (2.3.14) solved IVP for homogeneous equation with inhomogeneous initial data. Due to linearity we will be able to combine those formulae!

(b) Both (2.4.11) and (2.3.14) are valid for  $t > 0$  and for  $t < 0$ .

*Example 2.4.2.* (a) Find solution  $u(x, t)$  to

$$4u_{tt} - 9u_{xx} = \frac{x}{t+1} \quad -\infty < x < \infty, \quad -1 < t < \infty, \quad (2.4.12)$$

$$u|_{t=0} = 0, \quad u_t|_{t=0} = 0. \quad (2.4.13)$$

(b) If (2.4.12)–(2.4.13) are fulfilled for  $-3 < x < 3$  only, where solution is uniquely defined?

*Solution.* (a) Using D'Alembert formula

$$\begin{aligned} u(x, t) &= \frac{1}{12} \int_0^t \int_{x-\frac{3}{2}(t-\tau)/2}^{x+\frac{3}{2}(t-\tau)/2} \frac{\xi}{\tau+1} d\xi d\tau \\ &= \frac{1}{24} \int_0^t \frac{\left(x + \frac{3}{2}(t-\tau)\right)^2 - \left(x - \frac{3}{2}(t-\tau)\right)^2}{\tau+1} d\tau \\ &= \frac{1}{4} \int_0^t \frac{x(t-\tau)}{\tau+1} d\tau \\ &= \frac{1}{4} x \left( (t+1) \ln(t+1) - t \right). \end{aligned}$$

(b) Solution is uniquely defined at points  $(x, t)$  such that the base of the characteristic triangle is contained in  $[-3, 3]$ :

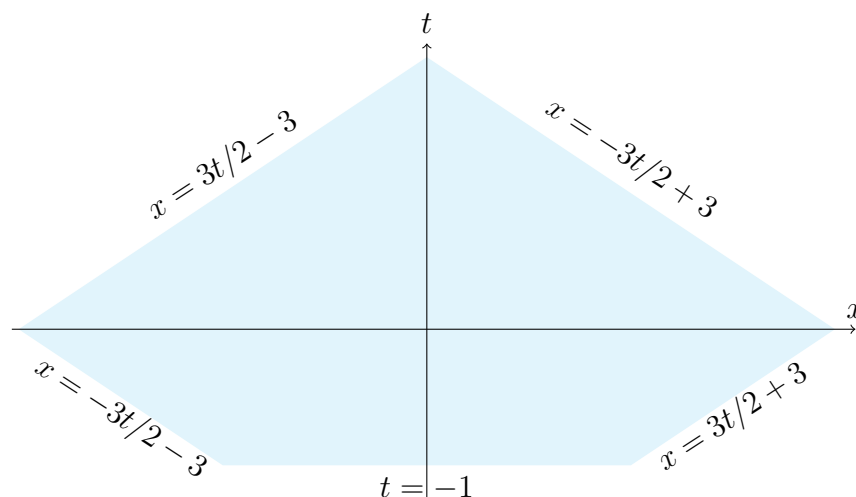

□

*Example 2.4.3.* Find solution  $u(x, t)$  to

$$u_{tt} - 4u_{xx} = \sin(x) \sin(2t) \quad -\infty < x < \infty, \quad -1 < t < \infty, \quad (2.4.14)$$

$$u|_{t=0} = 0, \quad u_t|_{t=0} = 0. \quad (2.4.15)$$

*Solution.* Using D'Alembert formula

$$\begin{aligned} u(x, t) &= \frac{1}{4} \int_0^t \int_{x-2(t-\tau)}^{x+2(t-\tau)} \sin(\xi) \sin(2\tau) d\xi d\tau \\ &= \frac{1}{4} \int_0^t \sin(2\tau) \left( \cos(x - 2t + 2\tau) - \cos(x + 2t - 2\tau) \right) d\tau \\ &= \frac{1}{2} \int_0^t \sin(2\tau) \sin(x) \sin(2t - 2\tau) d\tau \end{aligned}$$

where we used  $\cos(\alpha) - \cos(\beta) = 2 \sin\left(\frac{\beta+\alpha}{2}\right) \sin\left(\frac{\beta-\alpha}{2}\right)$ .

Then

$$\begin{aligned} u(x, t) &= \frac{1}{2} \int_0^t \sin(2\tau) \sin(x) \sin(2t - 2\tau) d\tau \\ &= \sin(x) \int_0^t \left( \cos(2t - 4\tau) - \cos(2t) \right) d\tau \\ &= \sin(x) \left[ -\frac{1}{4} \sin(2t - 4\tau) - \tau \cos(2t) \right]_{\tau=0}^{\tau=t} \\ &= \sin(x) \left[ \frac{1}{2} \sin(2t) - t \cos(2t) \right]. \end{aligned}$$

□

## Problems to Section 2.4

*Problem 1.* Solve IVP

$$\begin{cases} u_{tt} - c^2 u_{xx} = f(x, t); \\ u|_{t=0} = g(x), \\ u_t|_{t=0} = h(x) \end{cases}$$

with

$$\begin{aligned} f(x, t) &= \sin(\alpha x), & g(x) &= 0, & h(x) &= 0; \\ f(x, t) &= \sin(\alpha x) \sin(\beta t), & g(x) &= 0; & h(x) &= 0; \\ f(x, t) &= f(x), & g(x) &= 0, & h(x) &= 0; & \text{(a)} \\ f(x, t) &= f(x)t, & g(x) &= 0, & h(x) &= 0, & \text{(b)} \end{aligned}$$

in the case (a) assume that  $f(x) = F''(x)$  and in the case (b) assume that  $f(x) = F'''(x)$ .

*Problem 2.* Find formula for solution of the *Goursat problem*

$$\begin{cases} u_{tt} - c^2 u_{xx} = f(x, t), & x > c|t|, \\ u|_{x=-ct} = g(t), & t < 0, \\ u|_{x=ct} = h(t), & t > 0 \end{cases}$$

provided  $g(0) = h(0)$ .

*Hint.* Contribution of the right-hand expression will be

$$-\frac{1}{4c^2} \iint_{R(x,t)} f(x', t') dx' dt'$$

with  $R(x, t) = \{(x', t') : 0 < x' - ct' < x - ct, 0 < x' + ct' < x + ct\}$ .

*Problem 3.* Find the general solutions of the following equations:

$$\begin{cases} u_{xy} = u_x u_y u^{-1}; \\ u_{xy} = u_x u_y; \\ u_{xy} = \frac{u_x u_y u}{u^2 + 1}; \end{cases}$$

*Problem 4.* (a) Find solution  $u(x, t)$  to

$$\begin{cases} u_{tt} - u_{xx} = (x^2 - 1)e^{-\frac{x^2}{2}}, \\ u|_{t=0} = -e^{-\frac{x^2}{2}}, \quad u_t|_{t=0} = 0. \end{cases}$$

(b) Find  $\lim_{t \rightarrow +\infty} u(x, t)$ .

## 2.5 Wave equation reloaded (continued)

### 2.5.1 D'Alembert formula

We solved IVP with homogeneous ( $= 0$ ) initial data for inhomogeneous wave equation. Before this we solved IVP with inhomogeneous initial data for homogeneous wave equation. Now consider both inhomogeneous data and equation. So we consider problem (2.4.6)–(2.4.8)

$$u_{tt} - c^2 u_{xx} = f(x, t), \quad (2.5.1)$$

$$u|_{t=0} = g(x), \quad (2.5.2)$$

$$u_t|_{t=0} = h(x) \quad (2.5.3)$$

when neither  $f$ , nor  $g, h$  are necessarily equal to 0.

The good news is that our equation is linear and therefore  $u = u_2 + u_1$  where  $u_1$  satisfies problem with right-hand function  $f(x, t)$  but with  $g$  and  $h$  replaced by 0 and  $u_2$  satisfies the same problem albeit with  $f$  replaced by 0 and original  $g, h$ :

$$\begin{array}{ll} u_{1tt} - c^2 u_{1xx} = f(x, t), & u_{2tt} - c^2 u_{2xx} = 0, \\ u_1|_{t=0} = 0, & u_2|_{t=0} = g(x), \\ u_{1t}|_{t=0} = 0 & u_{2t}|_{t=0} = h(x). \end{array}$$

*Exercise 2.5.1.* Prove it.

Then  $u_1$  is given by (2.4.11) and  $u_2$  is given by (2.4.14) (with  $(f, g) \mapsto (g, h)$ ) and adding them we arrive to the final

$$u(x, t) = \underbrace{\frac{1}{2}[g(x+ct) + g(x-ct)] + \frac{1}{2c} \int_{x-ct}^{x+ct} h(y) dy}_{=u_2} + \underbrace{\frac{1}{2c} \iint_{\Delta(x,t)} f(x', t') dx dt'}_{=u_1}. \quad (2.5.4)$$

where recall that  $\Delta(x, t)$  is a *characteristic triangle*:

This formula (2.5.4) is also called *D'Alembert formula*.

*Remark 2.5.1.* Note that integral of  $h$  in  $u_2$  is taken over base of the characteristic triangle  $\Delta(x, t)$  and  $g$  is taken in the ends of this base.

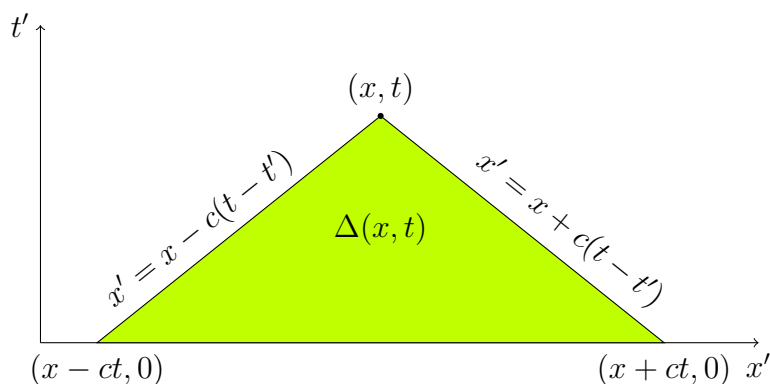

## 2.5.2 Duhamel integral

We discuss formula (2.5.4) in details in the next lecture and now let us derive it by a completely different method. Again, in virtue of (2.3.14) we need to consider only the case when  $g = h = 0$ . Let us define an auxiliary function  $U(x, t, \tau)$  ( $0 < \tau < t$ ) as a solution of an auxiliary problem

$$U_{tt} - c^2 U_{xx} = 0, \quad (2.5.5)$$

$$U|_{t=\tau} = 0, \quad (2.5.6)$$

$$U_t|_{t=\tau} = f(x, \tau). \quad (2.5.7)$$

We claim that

**Proposition 2.5.1.**

$$u(x, t) = \int_0^t U(x, t, \tau) d\tau \quad (2.5.8)$$

is a required solution.

*Proof.* Note first that we can differentiate (2.5.8) by  $x$  easily:

$$u_x = \int_0^t U_x(x, t, \tau) d\tau, \quad u_{xx} = \int_0^t U_{xx}(x, t, \tau) d\tau \quad (2.5.9)$$

and so on. Let us find  $u_t$ . Note that  $u$  depends on  $t$  through its upper limit and through integrand. We apply formula

$$\begin{aligned} \frac{d}{dt} \left( \int_{\alpha(t)}^{\beta(t)} F(t, \tau) d\tau \right) = \\ - F(t, \alpha(t))\alpha'(t) + F(t, \beta(t))\beta'(t) + \int_{\alpha(t)}^{\beta(t)} \frac{\partial F}{\partial t}(t, \tau) d\tau \end{aligned} \quad (2.5.10)$$

which you should know but we will prove it anyway.

As  $\alpha = 0$ ,  $\beta = t$  we have  $\alpha' = 0$ ,  $\beta' = 1$  and

$$u_t = U(x, t, t) + \int_0^t U_t(x, t, \tau) d\tau.$$

But  $U(x, t, t) = 0$  due to initial condition (2.5.6) and therefore

$$u_t = \int_0^t U_t(x, t, \tau) d\tau. \quad (2.5.11)$$

We can differentiate this with respect to  $x$  as in (2.5.9). Let us differentiate by  $t$ . Applying the same differentiation rule (2.5.10) we get

$$u_{tt} = U_t(x, t, t) + \int_0^t U_{tt}(x, t, \tau) d\tau.$$

Due to initial condition (2.5.7)  $U_t(x, t, t) = f(x, t)$ :

$$u_{tt} = f(x, t) + \int_0^t U_{tt}(x, t, \tau) d\tau.$$

Therefore

$$u_{tt} - c^2 u_{xx} = f(x, t) + \int_0^t \underbrace{(U_{tt} - c^2 U_{xx})}_{=0}(x, t, \tau) d\tau = f(x, t)$$

where integrand vanishes due to equation (2.5.5). So,  $u$  really satisfies equation (2.5.1). Due to (2.5.8) and (2.5.11)  $u|_{t=0} = u_t|_{t=0} = 0$ .

Formula (2.5.8) is *Duhamel integral formula*. □

*Remark 2.5.2.* (a) It is not important that it is wave equation: we need assume that equation is linear and has a form  $u_{tt} + Lu = f$  where  $Lu$  is a linear combination of  $u$  and its derivatives but with no more than 1 differentiation by  $t$ .



(b) The similar formula holds for equations of arbitrary order  $m$  with respect to  $t$  as long as the highest derivative with respect to  $t$  enters only as  $\partial_t^m u$ .

Now we claim that

$$U(x, t, \tau) = \frac{1}{2c} \int_{x-c(t-\tau)}^{x+c(t-\tau)} f(x', \tau) dx'. \quad (2.5.12)$$

Really, changing variable  $t' = t - \tau$  we get the same problem albeit with  $t'$  instead of  $t$  and with initial data at  $t' = 0$ .

Plugging (2.5.12) into (2.5.8) we get

$$u(x, t) = \int_0^t \frac{1}{2c} \left[ \int_{x-c(t-\tau)}^{x+c(t-\tau)} f(x', \tau) dx' \right] d\tau. \quad (2.5.13)$$

*Exercise 2.5.2.* Rewrite double integral (2.5.13) as a  $2D$ -integral in the right-hand expression of (2.4.11).

*Proof of (2.5.10).* Let us plug  $\gamma$  into  $F(x, t, \tau)$  instead of  $t$ . Then integral  $I(t) = J(\alpha(t), \beta(t), \gamma(t))$  with  $J(\alpha, \beta, \gamma) = \int_\alpha^\beta F(\gamma, \tau) d\tau$  and by chain rule  $I'(t) = J_\alpha \alpha' + J_\beta \beta' + J_\gamma \gamma'$ .

But  $J_\alpha = -F(\gamma, \alpha)$ ,  $J_\beta = F(\gamma, \beta)$  (differentiation by lower and upper limits) and  $J_\gamma = \int_\alpha^\beta F_\gamma(\gamma, \tau) d\tau$ . Plugging  $\gamma = t$ ,  $\gamma' = 1$  we arrive to (2.5.10).  $\square$

### 2.5.3 Domains of dependence and influence

Recall formula (2.5.4):

$$u(x, t) = \frac{1}{2} [g(x+ct) + g(x-ct)] + \frac{1}{2c} \int_{x-ct}^{x+ct} h(x') dx' + \frac{1}{2c} \iint_{\Delta(x,t)} f(x', t') dx' dt'$$

where  $\Delta(x, t)$  is the same characteristic triangle as above:

Therefore

**Proposition 2.5.2.** *Solution  $u(x, t)$  depends only on the right hand expression  $f$  in  $\Delta(x, t)$  and on the initial data  $g, h$  on the base of  $\Delta(x, t)$ .*

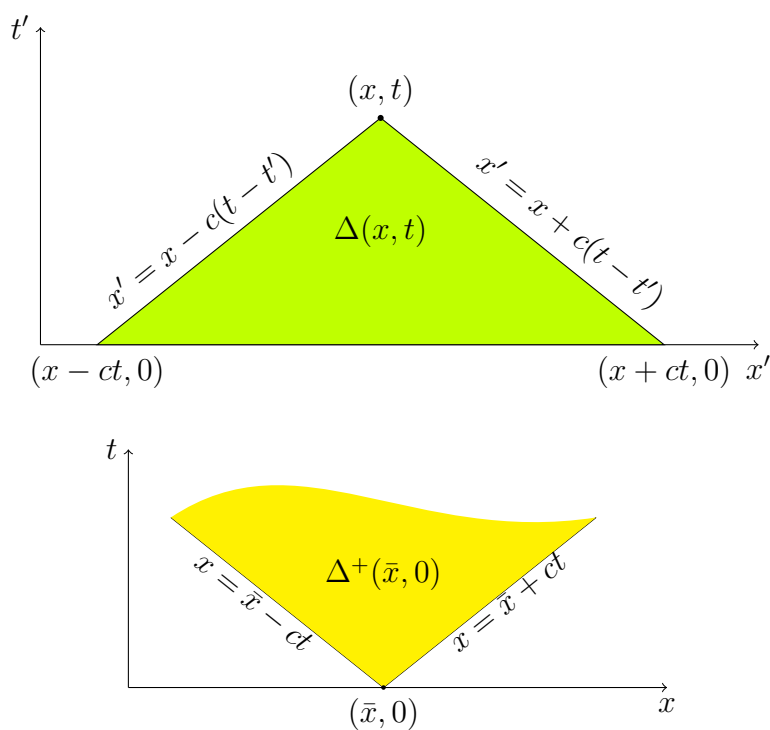

**Definition 2.5.1.**  $\Delta(x, t)$  is a *triangle of dependence* for point  $(x, t)$ .

Conversely, if we change functions  $g, h$  only near some point  $(\bar{x}, 0)$  then solution can change only at points  $(x, t)$  such that  $(\bar{x}, 0) \in \Delta(x, t)$ ; let  $\Delta^+(\bar{x}, 0)$  be the set of such points  $(x, t)$ :

**Definition 2.5.2.**  $\Delta^+(\bar{x}, 0)$  is a *triangle of influence* for point  $(\bar{x}, 0)$ .

*Remark 2.5.3.* (a) We can introduce *triangle of influence* for each point (not necessary at  $t = 0$ ).

(b) These notions work in much more general settings and we get *domain of dependence* and *domain of influence* which would not be triangles.

(c) F.e. for 3D wave equation  $u_{tt} - c^2(u_{xx} + u_{yy} + u_{zz}) = f$  those would be the *backward light cone* and *forward light cone* respectively and if  $c$  is variable instead of cones we get *conoids* (imagine tin cone and then deform it but the vertex should remain).

We see also that

**Proposition 2.5.3.** *Solution propagates with the speed not exceeding  $c$ .*

## 2.5.4 Examples

In examples we rewrite the last term in (2.5.4) as a double integral:

$$\begin{aligned}
 u(x, t) &= \frac{1}{2} [g(x + ct) + g(x - ct)] + \frac{1}{2c} \int_{x-ct}^{x+ct} h(x') dx' \\
 &\quad + \frac{1}{2c} \int_0^t \int_{x-c(t-t')}^{x+c(t-t')} f(x', t') dx' dt'. \quad (2.5.14)
 \end{aligned}$$

*Example 2.5.1.*

$$\begin{aligned}
 u_{tt} - 4u_{xx} &= \sin(x) \cos(t), \\
 u|_{t=0} &= 0, \\
 u_t|_{t=0} &= 0.
 \end{aligned}$$

Then  $c = 2$  and according to (2.5.14)

$$\begin{aligned}
 u(x, t) &= \frac{1}{4} \int_0^t \int_{x-2(t-t')}^{x+2(t-t')} \sin(x') \cos(t') dx' dt' \\
 &= \frac{1}{4} \int_0^t [\cos(x - 2(t - t')) - \cos(x + 2(t - t'))] \cos(t') dt' \\
 &= \frac{1}{2} \int_0^t \sin(x) \sin(2(t - t')) \cos(t') dt' \\
 &= \frac{1}{4} \sin(x) \int_0^t [\sin(2(t - t') + t') + \sin(2(t - t') - t')] dt' \\
 &= \frac{1}{4} \sin(x) \int_0^t [\sin(2t - t') + \sin(2t - 3t')] dt' \\
 &= \frac{1}{4} \sin(x) \left[ \cos(2t - t') + \frac{1}{3} \cos(2t - 3t') \right]_{t'=0}^{t'=t} \\
 &= \frac{1}{3} \sin(x) [\cos(t) - \cos(2t)].
 \end{aligned}$$

*Remark 2.5.4.* Sure, *separation of variables* would be simpler here.

Example 2.5.2. (a) Find solution  $u(x, t)$  to

$$2u_{tt} - 18u_{xx} = \frac{36}{t^2 + 1} \quad -\infty < x < \infty, \quad -\infty < t < \infty, \quad (2.5.15)$$

$$u|_{t=0} = x^2, \quad u_t|_{t=0} = 9x. \quad (2.5.16)$$

(b) If (2.5.15)–(2.5.16) are fulfilled for  $0 < x < 6$  only, where solution is uniquely defined?

Solution. (a) Using D'Alembert's formula

$$\begin{aligned} u(x, t) &= \frac{1}{2} \left( (x + 3t)^2 + (x - 3t)^2 \right) + \frac{3}{2} \int_{x-3t}^{x+3t} \xi d\xi \\ &\quad + 3 \int_0^t \int_{x-3(t-\tau)}^{x+3(t-\tau)} \frac{1}{\tau^2 + 1} d\xi d\tau = \\ &= \frac{x^2 + 9t^2}{2} + \frac{9xt}{2} + 18 \int_0^t \frac{t - \tau}{\tau^2 + 1} d\tau = \\ &= x^2 + 9xt + 9t^2 + 18t \arctan(t) - 9 \ln(t^2 + 1). \end{aligned}$$

(b)

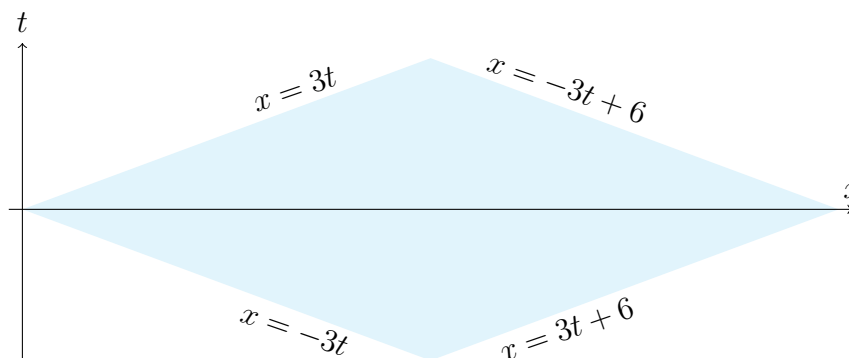

□

## 2.6 1D Wave equation: IBVP

### 2.6.1 1D Wave equation on half-line

Consider wave equation in domain  $\{x > 0, t > 0\}$  and initial conditions

$$u_{tt} - c^2 u_{xx} = 0 \quad x > 0, t > 0 \quad (2.6.1)$$

$$u|_{t=0} = g(x) \quad x > 0, \quad (2.6.2)$$

$$u_t|_{t=0} = h(x) \quad x > 0. \quad (2.6.3)$$

Here we take  $f(x, t) = 0$  for simplicity. Then according to the Section 2.5 solution  $u(x, t)$  is defined uniquely in the domain  $\{t > 0, x \geq ct\}$ :

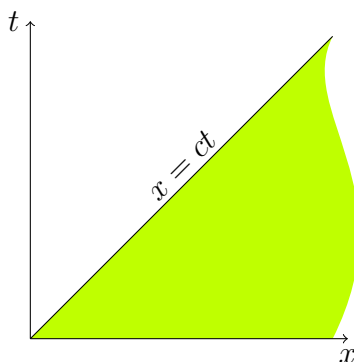

where it is given by D'Alembert formula

$$u(x, t) = \frac{1}{2}[g(x + ct) + g(x - ct)] + \frac{1}{2c} \int_{x-ct}^{x+ct} h(x') dx'. \quad (2.6.4)$$

What about domain  $\{0 < x < ct\}$ ? We claim that *we need one boundary condition at  $x = 0, t > 0$* . Indeed, recall that the general solution of (2.6.1) is

$$u(x, t) = \phi(x + ct) + \psi(x - ct) \quad (2.6.5)$$

where initial conditions (2.6.2)-(2.6.3) imply that

$$\begin{aligned} \phi(x) + \psi(x) &= g(x), \\ \phi(x) - \psi(x) &= \frac{1}{c} \int_0^x h(x') dx' \end{aligned}$$

for  $x > 0$  (where we integrated the second equation) and then

$$\phi(x) = \frac{1}{2}g(x) + \frac{1}{2c} \int_0^x h(x') dx', \quad x > 0, \quad (2.6.6)$$

$$\psi(x) = \frac{1}{2}g(x) - \frac{1}{2c} \int_0^x h(x') dx' \quad x > 0. \quad (2.6.7)$$

Therefore,  $\phi(x + ct)$  and  $\psi(x - ct)$  are defined respectively as  $x + ct > 0$  (which is automatic as  $x > 0, t > 0$ ) and  $x - ct > 0$  (which is fulfilled only as  $x > ct$ ).

To define  $\psi(x - ct)$  as  $0 < x < ct$  we need to define  $\psi(x)$  as  $x < 0$  and we need a boundary condition as  $x = 0, t > 0$ .

*Example 2.6.1.* Consider *Dirichlet boundary condition*

$$u|_{x=0} = p(t), \quad t > 0. \quad (2.6.8)$$

Plugging (2.6.5) we see that  $\phi(ct) + \psi(-ct) = p(t)$  as  $t > 0$  or equivalently  $\phi(-x) + \psi(x) = p(-x/c)$  for  $x < 0$  (and  $-x > 0$ ) where we plugged  $t := -x/c$ . Plugging (2.6.6) we have

$$\begin{aligned} \psi(x) = p(-x/c) - \phi(-x) = \\ p(-x/c) - \frac{1}{2}g(-x) - \frac{1}{2c} \int_0^{-x} h(x') dx'. \end{aligned} \quad (2.6.9)$$

Then plugging  $x := x + ct$  into (2.6.6) and  $x := x - ct$  into (2.6.9) and adding we get from (2.6.4) that

$$\begin{aligned} u(x, t) = & \underbrace{\frac{1}{2}g(x + ct) + \frac{1}{2c} \int_0^{x+ct} h(x') dx'}_{=\phi(x+ct)} \\ & + \underbrace{p(t - x/c) - \frac{1}{2}g(ct - x) - \frac{1}{2c} \int_0^{ct-x} h(x') dx'}_{=\psi(x-ct)}. \end{aligned} \quad (2.6.10)$$

This formula defines  $u(x, t)$  for  $0 < x < ct$ . Recall that for  $x > ct$  solution is given by (2.6.4).

(a) For  $g = h = 0$  (wave is generated by the perturbation at the (left) end)

$$u(x, t) = \begin{cases} 0 & 0 < ct < x, \\ p(t - x/c) & 0 < x < ct. \end{cases} \quad (2.6.11)$$

(b) For  $g(x) = \phi(x)$ ,  $h(x) = c\phi'(x)$ ,  $p(t) = 0$  (wave initially running to the left and then reflected from the (left) end)

$$u(x, t) = \begin{cases} \phi(x + ct) & 0 < ct < x, \\ \phi(x + ct) - \phi(ct - x) & 0 < x < ct. \end{cases} \quad (2.6.12)$$

*Example 2.6.2.* Alternatively, consider *Neumann boundary condition*

$$u_x|_{x=0} = q(t), \quad t > 0. \quad (2.6.13)$$

Plugging (2.6.5) we see that  $\phi'(ct) + \psi'(-ct) = q(t)$  as  $t > 0$  or equivalently  $\phi(-x) - \psi(x) = c \int_0^{-x/c} q(t') dt'$  for  $x < 0$  (and  $-x > 0$ ), where we integrated first and then plugged  $t := -x/c$ . (see also Remark below).

Plugging (2.6.6) we have

$$\begin{aligned} \psi(x) &= -c \int_0^{-x/c} q(t') dt' + \phi(x) = \\ &= -c \int_0^{-x/c} q(t') dt' + \frac{1}{2}g(-x) + \frac{1}{2c} \int_0^{-x} h(x') dx'. \end{aligned} \quad (2.6.14)$$

Then plugging  $x := x + ct$  into (2.6.6) and  $x := x - ct$  into (2.6.14) and adding we get from (2.6.4) that

$$\begin{aligned} u(x, t) &= \underbrace{\frac{1}{2}g(x + ct) + \frac{1}{2c} \int_0^{x+ct} h(x') dx'}_{=\phi(x+ct)} + \\ &= \underbrace{-c \int_0^{t-x/c} q(t') dt' + \frac{1}{2}g(ct - x) + \frac{1}{2c} \int_0^{ct-x} h(x') dx'}_{=\psi(x-ct)}. \end{aligned} \quad (2.6.15)$$

This formula defines  $u(x, t)$  as  $0 < x < ct$ . Recall that for  $x > ct$  solution is given by (2.6.4).

In particular

(a) For  $g = h = 0$  (wave is generated by the perturbation at the (left) end)

$$u(x, t) = \begin{cases} 0 & 0 < ct < x, \\ -c \int_0^{t-x/c} q(t') dt' & 0 < x < ct. \end{cases} \quad (2.6.16)$$

- (b) For  $g(x) = \phi(x)$ ,  $h(x) = c\phi'(x)$ ,  $q = 0$  (wave initially running to the left and then reflected from the (left) end)

$$u(x, t) = \begin{cases} \phi(x + ct) & 0 < ct < x, \\ \phi(x + ct) + \phi(ct - x) & 0 < x < ct. \end{cases} \quad (2.6.17)$$

*Remark 2.6.1.* One can ask in Example 2.6.2, why we took  $C = 0$  in  $\phi(-x) - \psi(x) = c \int_0^{-x/c} q(t') dt' + C$ . The short answer is that this choice provides continuity of the solution  $u(x, t)$  in  $(0, 0)$ . But then why we care about this here but not in Example 2.6.1?

Again the short answer is that now without this extra restriction we do not have uniqueness of the solution.

The proper answer is more complicated: the discontinuous solutions could be properly understood only in the framework of *weak solutions* (see Section 11.4); then, *if there are several solutions but only one of them is continuous, it is the only correct one*.

The same reasoning applies in Example 2.6.3 and Example 2.6.4 below.

*Example 2.6.3.* Alternatively, consider boundary condition

$$(\alpha u_x + \beta u_t)|_{x=0} = q(t), \quad t > 0. \quad (2.6.18)$$

Again we get equation to  $\psi(-ct)$ :  $(\alpha - c\beta)\psi'(-ct) + (\alpha + c\beta)\phi'(ct) = q(t)$  and everything works well as long as  $\alpha \neq c\beta$ .

*Exercise 2.6.1.* Explain why we need  $\alpha \neq c\beta$ .

*Example 2.6.4.* Alternatively, consider *Robin boundary condition*

$$(u_x + \sigma u)|_{x=0} = q(t), \quad t > 0. \quad (2.6.19)$$

and we get  $\psi'(-ct) + \sigma\psi(-ct) + \phi'(ct) + \sigma\phi(ct) = q(t)$  or, equivalently,

$$\psi'(x) + \sigma\psi(x) = q(-x/c) - \phi'(-x) + \sigma\phi(-x) \quad (2.6.20)$$

where the right-hand expression is known.

In this case we define  $\psi(x)$  at  $x < 0$  solving ODE (2.6.20) as we know  $\psi(0) = \frac{1}{2}g(0)$  from (2.6.7).

[Visual Examples \(animation\): Dirichlet, Neumann, Robin](#)



*Example 2.6.5.* Consider two wave equations

$$\begin{aligned} u_{tt} - c_1^2 u_{xx} &= 0 && \text{as } x > 0, \\ u_{tt} - c_2^2 u_{xx} &= 0 && \text{as } x < 0, \end{aligned}$$

intertwined through boundary conditions

$$\begin{aligned} u|_{x=0^+} &= u|_{x=0^-} \\ u_x|_{x=0^+} &= k u_x|_{x=0^-} \end{aligned}$$

with  $k > 0$ . Again we are looking for continuous  $u(x, t)$ .

Assume that  $u(x, 0) = 0$  for  $x < 0$ . In this case

(a)  $u(x, t) = \phi(t + c_1^{-1}x) + \psi(t - c_1^{-1}x)$  for  $x > 0$  and

(b)  $u(x, t) = \chi(t + c_2^{-1}x)$  for  $x < 0$

with  $\psi(t) = -\beta\phi(t)$ ,  $\chi(t) = \alpha\phi(t)$ ,  $\alpha = 2c_2(kc_1 + c_2)^{-1}$ ,  $\beta = (kc_1 - c_2)(kc_1 + c_2)^{-1}$ .

Then we have two *outgoing* waves: *reflected* wave  $\psi(t - c_1^{-1}x)$  and *refracted* wave  $\chi(t + c_2^{-1}x)$ .

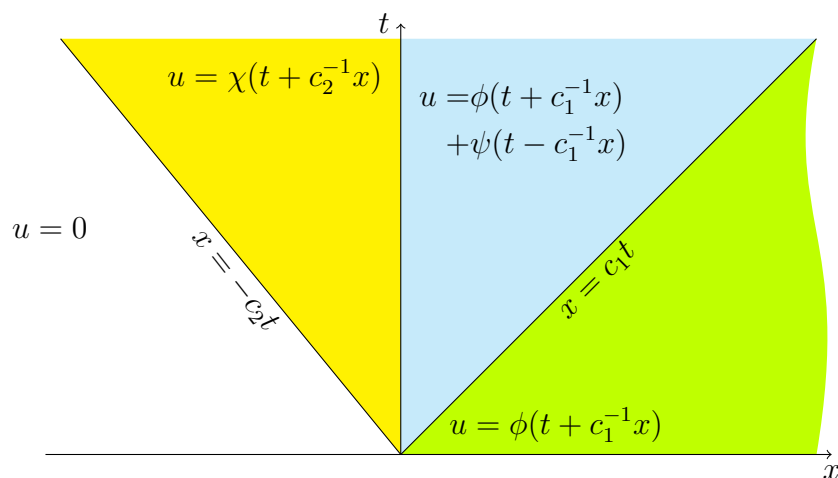

[Visual Example \(animation\)](#)

*Example 2.6.6.* Find continuous solution to

$$u_{tt} - 9u_{xx} = 0, \quad -\infty < t < \infty, \quad x > -t, \quad (2.6.21)$$

$$u|_{t=0} = 4 \cos(x), \quad x > 0, \quad (2.6.22)$$

$$u_t|_{t=0} = 18 \sin(x), \quad x > 0, \quad (2.6.23)$$

$$u_x|_{x=-t} = 0, \quad -\infty < t < \infty. \quad (2.6.24)$$

*Solution.* The general solution to (2.6.21) is

$$u(x, t) = \phi(x + 3t) + \psi(x - 3t). \quad (2.6.25)$$

Plugging into (2.6.22) and (2.6.23) we get

$$\phi(x) + \psi(x) = 4 \cos(x) \quad x > 0,$$

$$\phi(x) - \psi(x) = -6 \cos(x)$$

(the second equation after division by 3 and integration). Therefore

$$\phi(x) = -\cos(x) \quad \psi(x) = 5 \cos(x), \quad x > 0, \quad (2.6.26)$$

which defines solution

$$u = -\cos(x + 3t) + 5 \cos(x - 3t)$$

in the zone  $\{(x, t) : x > 3|t|\}$ .

Plugging (2.6.25) into (2.6.24) we get

$$\phi'(2t) + \psi'(-4t) = 0, \quad (2.6.27)$$

which for  $t > 0$  (we know  $\phi$ ) becomes

$$\begin{aligned} \sin(2t) + \psi'(-4t) = 0 &\implies \psi'(x) = -\sin(-x/2) = \sin(x/2) \implies \\ &\psi(x) = -2 \cos(x/2) + C \end{aligned}$$

and since  $\psi$  must be continuous at 0 we get  $C = 7$ ,  $\psi(x) = -2 \cos(x/2) + 7$  and we get solution

$$u = -\cos(x + 3t) - 2 \cos((x - 3t)/2) + 7$$

in the zone  $\{(x, t) : t > 0, -t < x < 3t\}$ .

For  $t < 0$  we know  $\psi$  and (2.6.24) becomes

$$\begin{aligned}\phi'(2t) - 5 \sin(-4t) = 0 &\implies \phi'(x) = 5 \sin(-2x) = -5 \sin(x) \implies \\ \phi(x) &= \frac{5}{2} \cos(2x) + D\end{aligned}$$

and since  $\phi$  must be continuous at 0 we get  $D = -\frac{7}{2}$ ,  $\phi(x) = \frac{5}{2} \cos(2x) - \frac{7}{2}$  and we get solution

$$u = \frac{5}{2} \cos(2x + 6) - \frac{7}{2} + 5 \cos(x - 3t)$$

in the zone  $\{(x, t) : t < 0, -t < x < -3t\}$ .

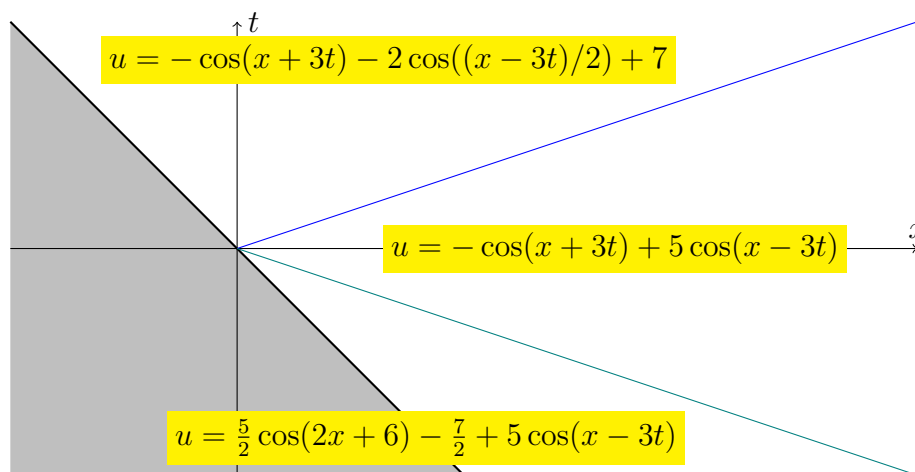

□

*Example 2.6.7.* Find continuous solution to

$$9u_{tt} - u_{xx} = 0, \quad -\infty < t < \infty, \quad x > -t, \quad (2.6.28)$$

$$u|_{t=0} = 4 \sin(3x), \quad x > 0, \quad (2.6.29)$$

$$u_t|_{t=0} = -2 \cos(3x), \quad x > 0, \quad (2.6.30)$$

$$u|_{x=-t} = u_x|_{x=-t} = 0, \quad 0 < t < \infty. \quad (2.6.31)$$

*Solution.* The general solution to (2.6.28) is

$$u(x, t) = \phi\left(x + \frac{t}{3}\right) + \psi\left(x - \frac{t}{3}\right). \quad (2.6.32)$$

Plugging into (2.6.29) and (2.6.30) we get

$$\phi(x) + \psi(x) = 4 \sin(3x) \quad x > 0,$$

$$\phi(x) - \psi(x) = -2 \sin(3x)$$

(the second equation after division by  $\frac{1}{3}$  and integration). Therefore

$$\phi(x) = \sin(3x), \quad \psi(x) = 3 \sin(3x), \quad x > 0, \quad (2.6.33)$$

which defines solution

$$u = \sin(3x + t) + 3 \sin(3x - t)$$

in the zone  $\{(x, t) : x > \frac{|t|}{3}\}$ .

Plugging (2.6.32) into (2.6.31) we get

$$\phi(-\frac{2}{3}t) + \psi(-\frac{4}{3}t) = 0, \quad \phi'(-\frac{2}{3}t) + \psi'(-\frac{4}{3}t) = 0, \quad t > 0; \quad (2.6.34)$$

Integrating the last equation we get  $2\phi(-\frac{2}{3}t) + \psi(-\frac{4}{3}t) = C$  for  $t > 0$   $\phi(x) = C$ ,  $\psi(x) = -C$  for  $x < 0$  and since  $\phi$  and  $\psi$  must be continuous at 0 we get  $C = 0$ , and we get solution

$$u(x, t) = \begin{cases} 0 & x < -\frac{t}{3}, t > 0, \\ \sin(3x + t) & -\frac{t}{3} < x < \frac{t}{3}, t > 0. \end{cases}$$

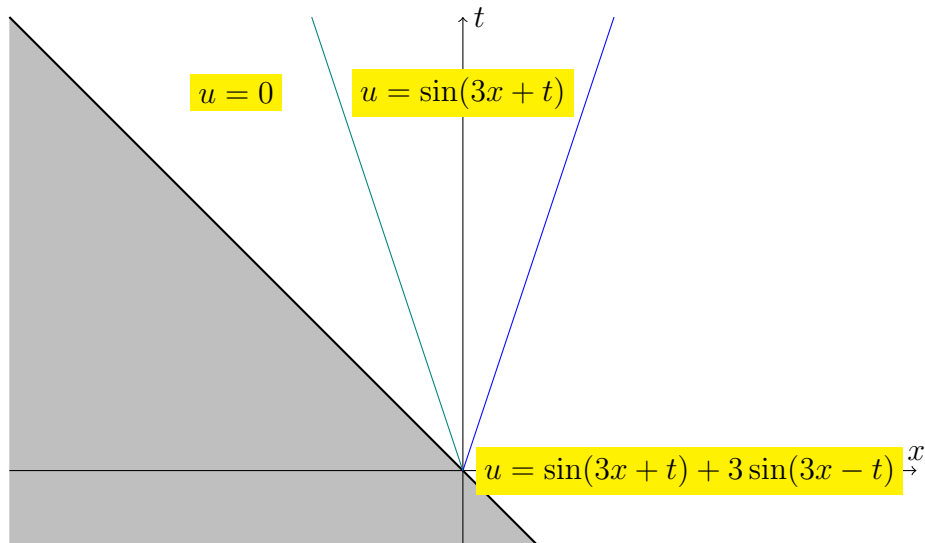

□

*Example 2.6.8.* Find continuous solution to

$$u_{tt} - 4u_{xx} = 0, \quad -\infty < t < \infty, \quad x > 0, \quad (2.6.35)$$

$$u|_{t=0} = 4 \cos(x), \quad x > 0, \quad (2.6.36)$$

$$u_t|_{t=0} = 16 \sin(x), \quad x > 0, \quad (2.6.37)$$

$$(u_x + u)|_{x=0} = 0, \quad -\infty < t < \infty. \quad (2.6.38)$$

*Solution.* The general solution to (2.6.35) is

$$u(x, t) = \phi(x + 2t) + \psi(x - 2t). \quad (2.6.39)$$

Plugging into (2.6.36) and (2.6.37) we get

$$\phi(x) + \psi(x) = 4 \cos(x) \quad x > 0,$$

$$\phi(x) - \psi(x) = -8 \cos(x)$$

(the second equation after division by 2 and integration). Therefore

$$\phi(x) = -2 \cos(x), \quad \psi(x) = 6 \cos(x), \quad x > 0, \quad (2.6.40)$$

which defines solution  $u = -2 \cos(x + 2t) + 6 \cos(x - 2t)$  in the zone  $\{(x, t) : x > 2|t|\}$ .

Plugging (2.6.39) into (2.6.38) we get

$$3\phi'(2t) - \psi'(-2t) = 0, \quad (2.6.41)$$

which for  $t > 0$  (we know  $\phi$ ) becomes

$$\psi'(-2t) = -6 \sin(2t) \implies \psi'(x) = 6 \sin(x) \implies \psi(x) = -6 \cos(x) + C$$

and since  $\psi$  must be continuous at 0 we get  $C = 4$ ,  $\psi(x) = -6 \cos(x) + 4$  and we get solution  $u = -2 \cos(x + 2t) - 6 \cos(x - 2t) + 4$  in the zone  $\{(x, t) : t > 0, 0 < x < 2t\}$ .

For  $t < 0$  we know  $\psi$  and (2.6.41) becomes

$$\phi'(2t) = -2 \sin(2t) \implies \phi'(x) = -2 \sin(x) \implies \phi(x) = 2 \cos(x) + D$$

and since  $\phi$  must be continuous at 0 we get  $D = -4$ ,  $\phi(x) = 2 \cos(x) - 4$  and we get solution  $u = 2 \cos(x + 2t) + 6 \cos(x - 2t) - 4$  in the zone  $\{(x, t) : t < 0, 0 < x < -2t\}$ .

□

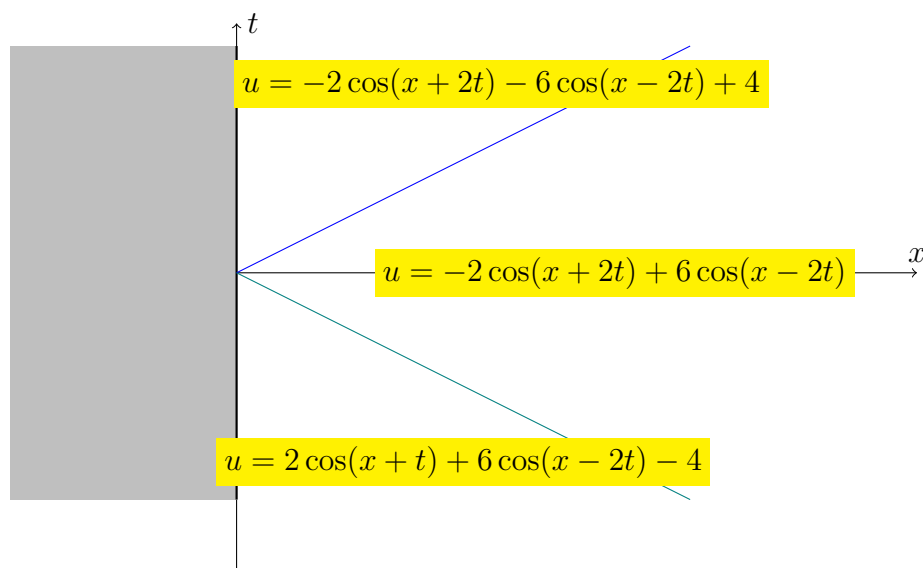

## 2.6.2 Physical examples of boundary conditions

For a *string equation*

$$\rho u_{tt} - T u_{xx} = 0$$

where  $u = u(x, t)$  is a displacement in the orthogonal direction,  $\rho$  is a linear density and  $T$  is a tension (see Example 1.4.1):

- (a) On the *fixed left end*  $x = 0$  we have Dirichlet boundary condition  $u(0, t) = 0$ . And similarly on the *fixed right end*  $x = l$  boundary condition is  $u(l, t) = 0$ .
- (b) On the other hand, consider a *free left end*. To prevent the string from shrinking we may fix it on the massless sleeve sliding freely along the rod, orthogonal to the string. Then since the force, the string pulls up its left (right) end is  $Tu_x$  ( $-Tu_x$ ), we have Neumann boundary condition  $u_x(0, t) = 0$  (on the *free right end*  $u_x(l, t) = 0$  correspondingly).
- (c) If we add a spring so there would be the return force  $-ku$  where  $k$  is the Hooke's coefficient of this spring, we have Robin boundary condition  $(Tu_x - ku)(0, t) = 0$  ( $(-Tu_x - ku)(l, t) = 0$  correspondingly).

For 1-dimensional airflow in the air pipe

$$\rho_0 v_t + p'(\rho_0) \rho_x = 0, \quad (\text{A})$$

$$\rho_t + \rho_0 v_x = 0 \quad (\text{B})$$

where  $\rho_0$  is a “normal” density,  $\rho(x, t)$  is excess density (so  $\rho_0 + \rho$  is a density),  $v(x, t)$  is a velocity, and  $p = p(\rho)$  is a pressure (see Example 1.4.3) one can see that both  $\rho$  and  $v$  satisfy wave equation

$$\rho_{tt} - c^2 \rho_{xx} = 0, \quad (\text{C})$$

$$v_{tt} - c^2 v_{xx} = 0 \quad (\text{D})$$

with  $c^2 = p'(\rho_0)$ .

- (a) On the *closed end* the velocity is 0, so on the *closed left end*  $x = 0$  we have  $v(0, t) = 0$  and  $\rho_x(0, t) = 0$  for (C) and (D) correspondingly.
- (b) On the *open end* the excess pressure is 0, so on the *open left end*  $x = 0$  we have  $v_x(0, t) = 0$  and  $\rho(0, t) = 0$  for (C) and (D) correspondingly.
- (c) Assume that the left end has a massless piston which is connected to a spring with Hooke’s coefficient  $k$ . Then the shift of the piston from the equilibrium to the right equals  $\int_0^t v(0, t) dt$  (assuming that it was in such position at  $t = 0$ ).

Then the force of the spring is  $-k \int_0^t v(0, t) dt$ . On the other hand, the excess pressure is  $p'(\rho_0) \rho$  and  $-k \int_0^t v(0, t) dt + p'(\rho_0) \rho = 0$  is the balance.

Then  $kv(0, t) = p'(\rho_0) \rho_t = p'(\rho_0) \rho_0 v_x$  due to (B) and we get  $(-kv + p'(\rho_0) \rho_0 v_x)(0, t) = 0$ ; correspondingly, on the right end it would be  $(kv + p'(\rho_0) \rho_0 v_x)(l, t) = 0$ .

### 2.6.3 1D wave equation on the finite interval

Consider wave equation in domain  $\{a < x < b, t > 0\}$  and initial conditions

$$u_{tt} - c^2 u_{xx} = 0 \quad a < x < b, t > 0 \quad (2.6.42)$$

$$u|_{t=0} = g(x) \quad a < x < b, \quad (2.6.43)$$

$$u_t|_{t=0} = h(x) \quad a < x < b. \quad (2.6.44)$$

Here we take  $f(x, t) = 0$  for simplicity. Then according to Section 2.5 solution  $u(x, t)$  is defined uniquely in the characteristic triangle  $ABC$ .

However  $\phi(x)$ ,  $\psi(x)$  are defined for  $a < x < b$ , so  $\phi(x + ct)$  is defined in  $ABA'$  and  $\psi(x - ct)$  is defined in  $ABB'$ :

Now the boundary condition on the left end (f. e.  $u|_{x=a} = p_l(t)$ , or  $u_x|_{x=a} = q_l(t)$ , or more general condition) allows us to find  $\psi(a - ct)$  for  $0 < t < (b - a)/c$  and then  $\psi(x - ct)$  is defined in  $ABB''A'$ . Similarly the boundary condition on the right end (f. e.  $u|_{x=b} = p_r(t)$ , or  $u_x|_{x=b} = q_r(t)$ , or more general condition) allows us to find  $\phi(b + ct)$  for  $0 < t < (b - a)/c$  and then  $\phi(x + ct)$  is defined in  $ABB'A''$ . So,  $u$  is defined in the intersection of those two domains which is  $AA'C'B'B$ .

Continuing this process in steps we define  $\phi(x + ct)$ ,  $\psi(x - ct)$  and  $u(x, t)$  in expanding “up” set of domains.

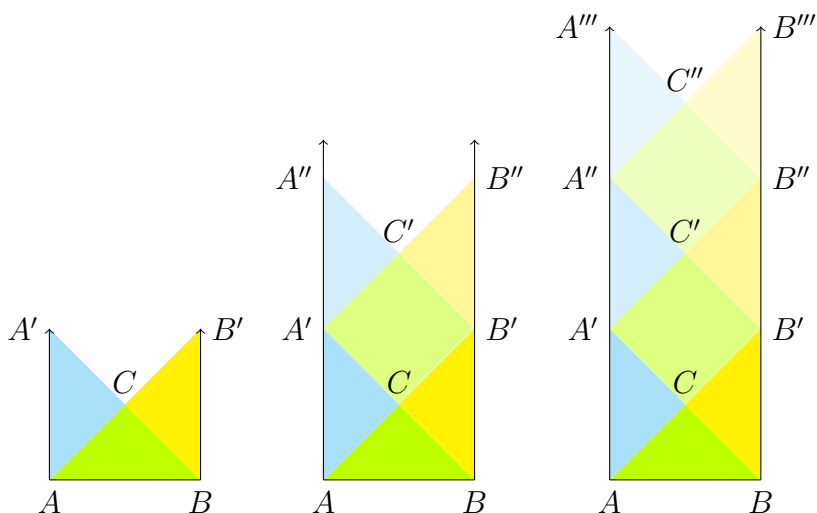



### 2.6.4 Half-line: method of continuation

Consider wave equation in domain  $\{x > 0, t > 0\}$ , initial conditions, and a Dirichlet boundary condition

$$u_{tt} - c^2 u_{xx} = f(x, t) \quad x > 0, \quad (2.6.45)$$

$$u|_{t=0} = g(x) \quad x > 0, \quad (2.6.46)$$

$$u_t|_{t=0} = h(x) \quad x > 0, \quad (2.6.47)$$

$$u|_{x=0} = 0. \quad (2.6.48)$$

Alternatively, instead of Dirichlet boundary condition . we consider Neumann boundary condition.

$$u_x|_{x=0} = 0. \quad (2.6.48)'$$

*Remark 2.6.2.* It is crucial that we consider either Dirichlet or Neumann homogeneous boundary conditions.

To deal with this problem consider first IVP on the whole line:

$$U_{tt} - c^2 U_{xx} = F(x, t) \quad x > 0, \quad (2.6.49)$$

$$U|_{t=0} = G(x) \quad x > 0, \quad (2.6.50)$$

$$U_t|_{t=0} = H(x) \quad x > 0, \quad (2.6.51)$$

and consider  $V(x, t) = \varsigma U(-x, t)$  with  $\varsigma = \pm 1$ .

**Proposition 2.6.1.** *If  $U$  satisfies (2.6.49)–(2.6.51) then  $V$  satisfies similar problem albeit with right-hand expression  $\varsigma F(-x, t)$ , and initial functions  $\varsigma G(-x)$  and  $\varsigma H(-x)$ .*

*Proof.* Plugging  $V$  into equation we use the fact that  $V_t(x, t) = \varsigma U_t(-x, t)$ ,  $V_x(x, t) = -\varsigma U_x(-x, t)$ ,  $V_{tt}(x, t) = \varsigma U_{tt}(-x, t)$ ,  $V_{tx}(x, t) = -\varsigma U_{tx}(-x, t)$ ,  $V_{xx}(x, t) = \varsigma U_{xx}(-x, t)$  etc and exploit the fact that *wave equation contains only even-order derivatives with respect to  $x$ .*

Note that

(a) if  $F, G, H$  are even functions with respect to  $x$ , and  $\varsigma = 1$  then  $V(x, t)$  satisfies the same IVP as  $U(x, t)$ .

(b) Similarly, if  $F, G, H$  are odd functions with respect to  $x$ , and  $\varsigma = -1$  then  $V(x, t)$  satisfies the same IVP as  $U(x, t)$ .

However we know that solution of (2.6.49)-(2.6.51) is unique and therefore  $U(x, t) = V(x, t) = \varsigma U(-x, t)$ .  $\square$

Therefore

**Corollary 2.6.2.** (i) If  $\varsigma = -1$  and  $F, G, H$  are odd functions with respect to  $x$  then  $U(x, t)$  is also an odd function with respect to  $x$ .

(ii) If  $\varsigma = 1$  and  $F, G, H$  are even functions with respect to  $x$  then  $U(x, t)$  is also an even function with respect to  $x$ .

However we know that

- (a) odd function with respect to  $x$  vanishes as  $x = 0$ ;
- (b) derivative of the even function with respect to  $x$  vanishes as  $x = 0$

and we arrive to

**Corollary 2.6.3.** (i) In the framework of Corollary 2.6.2(i)  $U(x, t)$  satisfies Dirichlet boundary condition;

(ii) In the framework of Corollary 2.6.2(ii)  $U(x, t)$  satisfies Neumann boundary condition.

Therefore

**Corollary 2.6.4.** (i) To solve (2.6.45)–(2.6.47), (2.6.48) we need to take an odd continuation of  $f, g, h$  to  $x < 0$  and solve the corresponding IVP;

(ii) To solve (2.6.45)–(2.6.47), (2.6.48)' we need to take an even continuation of  $f, g, h$  to  $x < 0$  and solve the corresponding IVP.

So far we have not used much that we have exactly wave equation (similar arguments with minor modification work for heat equation as well etc). Now we apply D'Alembert formula (2.5.4)

$$u(x, t) = \frac{1}{2}(G(x + ct) + G(x - ct)) + \frac{1}{2c} \int_{x-ct}^{x+ct} H(x') dx' + \frac{1}{2c} \int_0^t \int_{x-c(t-t')}^{x+c(t-t')} F(x', t') dx' dt'$$

and we need to take  $0 < x < ct$ , resulting for  $f = 0 \implies F = 0$

$$u(x, t) = \frac{1}{2}(g(ct + x) - g(ct - x)) + \frac{1}{2c} \int_{ct-x}^{ct+x} h(x') dx', \quad (2.6.52)$$

and

$$u(x, t) = \frac{1}{2}(g(ct + x) + g(ct - x)) + \frac{1}{2c} \int_0^{ct-x} h(x') dx' + \frac{1}{2c} \int_0^{ct+x} h(x') dx' \quad (2.6.52)'$$

for boundary condition (2.6.48) and (2.6.48)' respectively.

*Example 2.6.9.* Consider wave equation with  $c = 1$  and let  $f = 0$ ,

(a)  $g = \sin(x)$ ,  $h = 0$  and Dirichlet boundary condition. Obviously  $G(x) = \sin(x)$  (since we take odd continuation and  $\sin(x)$  is an odd function). Then

$$u(x, t) = \frac{1}{2}(\sin(x + t) + \sin(x - t)) = \sin(x) \cos(t). \quad (2.6.53)$$

(b)  $g = \sin(x)$ ,  $h = 0$  and Neumann boundary condition. Obviously  $G(x) = -\sin(x)$  as  $x < 0$  (since we take even continuation and  $\sin(x)$  is an odd function). Then  $u$  is given by (2.6.53) for  $x > t > 0$  and

$$u(x, t) = \frac{1}{2}(\sin(x + t) - \sin(x - t)) = \sin(t) \cos(x) \quad (2.6.54)$$

as  $0 < x < t$ .

(c)  $g = \cos(x)$ ,  $h = 0$  and Neumann boundary condition. Obviously  $G(x) = \cos(x)$ . Then

$$u(x, t) = \frac{1}{2}(\cos(x + t) + \cos(x - t)) = \cos(x) \cos(t). \quad (2.6.55)$$

(d)  $g = \cos(x)$ ,  $h = 0$  and Dirichlet boundary condition. Obviously  $G(x) = -\cos(x)$  as  $x < 0$ . Then  $u$  is given by (2.6.56) for  $x > t > 0$  and

$$u(x, t) = \frac{1}{2}(\cos(x + t) - \cos(x - t)) = -\sin(t) \sin(x) \quad (2.6.56)$$

as  $0 < x < t$ .

### 2.6.5 Finite interval: method of continuation

Consider the same problem albeit on interval  $0 < x < l$  with either Dirichlet or Neumann condition on each end. Then we need to take

- (a) odd continuation through “Dirichlet end” and
- (b) even continuation through “Neumann end”.

On figures below we have respectively Dirichlet conditions on each end (indicated by red), Neumann conditions on each end (indicated by green), and Dirichlet condition on one end (indicated by red) and Neumann conditions on another end (indicated by teal).

Resulting continuations are  $2l$ ,  $2l$  and  $4l$  periodic respectively.

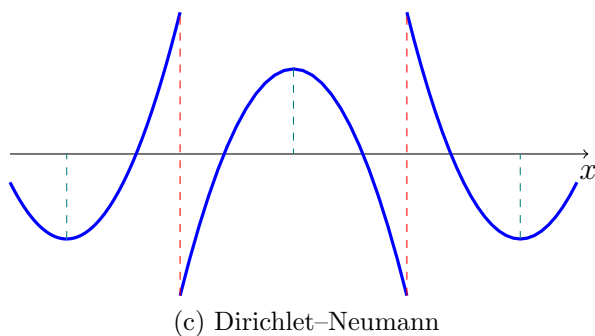
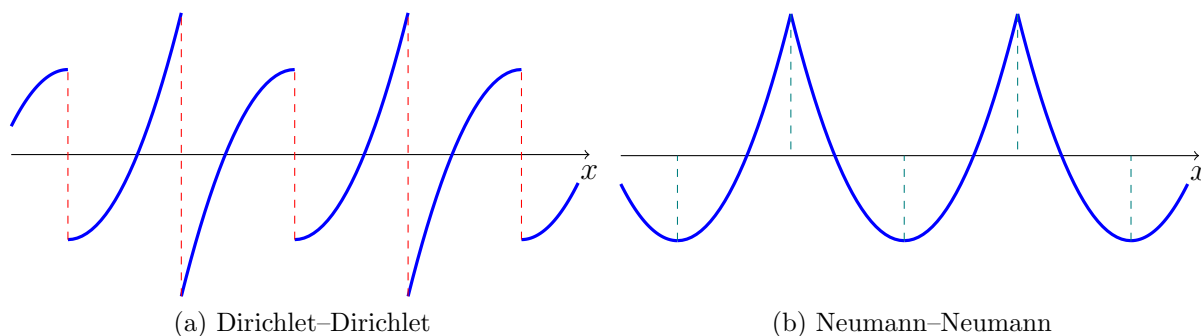

[Visual Examples \(animation\)](#)

*Example 2.6.10.* Consider  $u(x, t)$  a solution of

$$\begin{aligned}u_{tt} - 9u_{xx} &= 0, \\u|_{t=0} &= \sin(\pi x), \\u_t|_{t=0} &= 0\end{aligned}$$

on  $(0, 1)$ . In the cases of boundary conditions

- (a)  $u|_{x=0} = u|_{x=1} = 0$ ,
- (b)  $u_x|_{x=0} = u_x|_{x=1} = 0$ ,
- (c)  $u|_{x=0} = u_x|_{x=1} = 0$

calculate  $u(.5, 17.3)$  and  $u(.3, 17.5)$ .

*Solution.* Let  $G(x)$  be a corresponding continuation of  $g(x) = \sin(\pi x)$ . Then  $u(x, t) = \frac{1}{2}[G(x - 3t) + G(x + 3t)]$  and we have

$$u(.5, 17.3) = \frac{1}{2}[G(-51.4) + G(52.4)] = \frac{1}{2}[G(.6) + G(.4)].$$

□

## Problems to Section 2.6

*Problem 1.* (a) Find solution

$$\begin{cases} u_{tt} - c^2 u_{xx} = 0, & t > 0, x > 0, \\ u|_{t=0} = \phi(x), & x > 0, \\ u_t|_{t=0} = c\phi'(x), & x > 0, \\ u|_{x=0} = \chi(t), & t > 0. \end{cases}$$

(separately in  $x > ct$  and  $0 < x < ct$ ).

(b) Find solution

$$\begin{cases} u_{tt} - c^2 u_{xx} = 0, & t > 0, x > 0, \\ u|_{t=0} = \phi(x), & x > 0, \\ u_t|_{t=0} = c\phi'(x), & x > 0, \\ u_x|_{x=0} = \chi(t), & t > 0. \end{cases}$$

(separately in  $x > ct$  and  $0 < x < ct$ ).

*Problem 2.* (a) Find solution

$$\begin{cases} u_{tt} - c_1^2 u_{xx} = 0, & t > 0, x > 0, \\ u_{tt} - c_2^2 u_{xx} = 0, & t > 0, x < 0, \\ u|_{t=0} = \phi(x), & u_t|_{t=0} = c_1 \phi'(x) & x > 0, \\ u|_{t=0} = 0, & u_t|_{t=0} = 0, & x < 0, \\ u|_{x=+0} = \alpha u|_{x=-0}, & u_x|_{x=+0} = \beta u_x|_{x=-0} & t > 0 \end{cases}$$

(separately in  $x > c_1 t$ ,  $0 < x < c_1 t$ ,  $-c_2 t < x < 0$  and  $x < -c_2 t$ ).

(b) Discuss *reflected wave* and *refracted wave*.

*Problem 3.* (a) Find solution

$$\begin{cases} u_{tt} - c_1^2 u_{xx} = 0, & t > 0, x > 0, \\ v_{tt} - c_2^2 v_{xx} = 0, & t > 0, x < 0, \\ u|_{t=0} = \phi(x), & u_t|_{t=0} = c_1 \phi'(x) & x > 0, \\ v|_{t=0} = 0, & v_t|_{t=0} = 0, & x < 0, \\ (u + \alpha v)|_{x=0} = 0, & (u_x + \beta v_x)|_{x=0} = 0 & t > 0 \end{cases}$$

(for  $u$  separately in  $x > c_1 t$ , and for  $v$  separately in  $0 < x < c_2 t$ ).

(b) Discuss two *reflected waves*. In particular, consider  $\phi(x) = e^{ikx}$ .

(c) Discuss connection to 2.

*Problem 4.* (a) Find solution

$$\begin{cases} u_{tt} - c^2 u_{xx} = 0, & t > 0, x > 0, \\ u|_{t=0} = \phi(x), & u_t|_{t=0} = c \phi'(x) & x > 0, \\ (u_x + \alpha u)|_{x=0} = 0, & & t > 0 \end{cases}$$

(separately in  $x > ct$ , and  $0 < x < ct$ ).

(b) Discuss *reflected wave*. In particular, consider  $\phi(x) = e^{ikx}$ .

*Problem 5.* (a) Find solution

$$\begin{cases} u_{tt} - c^2 u_{xx} = 0, & t > 0, x > 0, \\ u|_{t=0} = \phi(x), & u_t|_{t=0} = c \phi'(x) & x > 0, \\ (u_x + \alpha u_t)|_{x=0} = 0, & & t > 0 \end{cases}$$

(separately in  $x > ct$ , and  $0 < x < ct$ ).

(b) Discuss *reflected wave*. In particular, consider  $\phi(x) = e^{ikx}$ .

*Problem 6.* (a) Find solution

$$\begin{cases} u_{tt} - c^2 u_{xx} = 0, & t > 0, x > 0, \\ u|_{t=0} = \phi(x), & u_t|_{t=0} = c\phi'(x) & x > 0, \\ (u_x - \alpha u_{tt})|_{x=0} = 0, & & t > 0 \end{cases}$$

(separately in  $x > ct$ , and  $0 < x < ct$ ).

(b) Discuss *reflected wave*. In particular, consider  $\phi(x) = e^{ikx}$ .

*Problem 7.* Consider equation with the initial conditions

$$\begin{cases} u_{tt} - c^2 u_{xx} = 0, & t > 0, x > vt, \\ u|_{t=0} = f(x), & x > 0, \\ u_t|_{t=0} = g(x), & x > 0. \end{cases}$$

(a) Find which of these conditions (A)-(D) below at  $x = vt$ ,  $t > 0$  could be added to this problem, so that the resulting problem would have a unique solution and solve the problem you deemed as a good one:

(A) None,

(B)  $u|_{x=vt} = 0$  ( $t > 0$ ),

(C)  $(\alpha u_x + \beta u_t)|_{x=vt} = 0$  ( $t > 0$ ),

(D)  $u|_{x=vt} = u_x|_{x=vt} = 0$  ( $t > 0$ ). Consider cases  $v > c$ ,  $-c < v < c$  and  $v < -c$ . In the case condition (C) find necessary restrictions to  $\alpha, \beta$ .

(b) Find solution in the cases when it exists and is uniquely determined; consider separately zones  $x > ct$ ,  $-ct < -x < -ct$  and  $x > ct$  (intersected with  $x > vt$ ).

*Problem 8.* By method of continuation combined with D'Alembert formula solve each of the following twelve problems below.

$$\begin{cases} u_{tt} - c^2 u_{xx} = 0, & x > 0, \\ u|_{t=0} = 0, & x > 0, \\ u_t|_{t=0} = \cos(x), & x > 0, \\ u|_{x=0} = 0, & t > 0; \end{cases} \quad \begin{cases} u_{tt} - c^2 u_{xx} = 0, & x > 0, \\ u|_{t=0} = 0, & x > 0, \\ u_t|_{t=0} = \cos(x), & x > 0, \\ u_x|_{x=0} = 0, & t > 0; \end{cases}$$

$$\begin{array}{l}
\left\{ \begin{array}{ll} u_{tt} - c^2 u_{xx} = 0, & x > 0, \\ u|_{t=0} = 0, & x > 0, \\ u_t|_{t=0} = \sin(x), & x > 0, \\ u|_{x=0} = 0, & t > 0; \end{array} \right. & \left\{ \begin{array}{ll} u_{tt} - c^2 u_{xx} = 0, & x > 0, \\ u|_{t=0} = 0, & x > 0, \\ u_t|_{t=0} = \sin(x), & x > 0, \\ u_x|_{x=0} = 0, & t > 0; \end{array} \right. \\
\left\{ \begin{array}{ll} u_{tt} - c^2 u_{xx} = 0, & x > 0, \\ u|_{t=0} = \cos(x), & x > 0, \\ u_t|_{t=0} = 0, & x > 0, \\ u|_{x=0} = 0, & t > 0; \end{array} \right. & \left\{ \begin{array}{ll} u_{tt} - c^2 u_{xx} = 0, & x > 0, \\ u|_{t=0} = \cos(x), & x > 0, \\ u_t|_{t=0} = 0, & x > 0, \\ u_x|_{x=0} = 0, & t > 0; \end{array} \right. \\
\left\{ \begin{array}{ll} u_{tt} - c^2 u_{xx} = 0, & x > 0, \\ u|_{t=0} = \sin(x), & x > 0, \\ u_t|_{t=0} = 0, & x > 0, \\ u|_{x=0} = 0, & t > 0; \end{array} \right. & \left\{ \begin{array}{ll} u_{tt} - c^2 u_{xx} = 0, & x > 0, \\ u|_{t=0} = \sin(x), & x > 0, \\ u_t|_{t=0} = 0, & x > 0, \\ u_x|_{x=0} = 0, & t > 0; \end{array} \right. \\
\left\{ \begin{array}{ll} u_{tt} - c^2 u_{xx} = 0, & x > 0, \\ u|_{t=0} = 1, & x > 0, \\ u_t|_{t=0} = 0, & x > 0, \\ u_x|_{x=0} = 0, & t > 0; \end{array} \right. & \left\{ \begin{array}{ll} u_{tt} - c^2 u_{xx} = 0, & x > 0, \\ u|_{t=0} = 1, & x > 0, \\ u_t|_{t=0} = 0, & x > 0, \\ u|_{x=0} = 0, & t > 0; \end{array} \right. \\
\left\{ \begin{array}{ll} u_{tt} - c^2 u_{xx} = 0, & x > 0, \\ u|_{t=0} = 0, & x > 0, \\ u_t|_{t=0} = 1, & x > 0, \\ u_x|_{x=0} = 0, & t > 0; \end{array} \right. & \left\{ \begin{array}{ll} u_{tt} - c^2 u_{xx} = 0, & x > 0, \\ u|_{t=0} = 0, & x > 0, \\ u_t|_{t=0} = 1, & x > 0, \\ u|_{x=0} = 0, & t > 0. \end{array} \right.
\end{array}$$

*Problem 9.* Solve

$$\begin{cases} (t^2 + 1)u_{tt} + tu_t - u_{xx} = 0, \\ u|_{t=0} = 0, \quad u_t|_{t=0} = 1. \end{cases} \quad (13)$$

*Hint:* Make a change of variables  $x = \frac{1}{2}(\xi + \eta)$ ,  $t = \sinh(\frac{1}{2}(\xi - \eta))$  and calculate  $u_\xi$ ,  $u_\eta$ ,  $u_{\xi\eta}$ .



*Problem 10.* Consider problem:

$$\begin{cases} u_{tt} - c^2 u_{xx} = f(x, t), & x > 0, t > 0, \\ u|_{t=0} = g(x), \\ u_t|_{t=0} = h(x), \\ u|_{x=0} = p(t). \end{cases}$$

and another problem

$$\begin{cases} u_{tt} - c^2 u_{xx} = f(x, t), & x > 0, t > 0, \\ u|_{t=0} = g(x), \\ u_t|_{t=0} = h(x), \\ u_x|_{x=0} = q(t). \end{cases}$$

Assuming that all functions  $g, h$  and either  $p$  or  $q$  are sufficiently smooth, find conditions necessary for solution  $u$  be

- (a)  $C$  in  $\{x > 0, t > 0\}$  (was on the lecture);
- (b)  $C^1$  in  $\{x > 0, t > 0\}$ ;
- (c)  $C^2$  in  $\{x > 0, t > 0\}$ ;
- (d)  $C^3$  in  $\{x > 0, t > 0\}$

where  $C^n$  is the class on  $n$ -times continuously differentiable functions.

*Hint:* These *compatibility conditions* are on  $f, g, h$  and either  $p$  or  $q$  and may be their derivatives as  $x = t = 0$ . Increasing smoothness by 1 adds one condition. You do not need to solve problem, just plug and may be differentiate.

## 2.7 Energy integral

### 2.7.1 Wave equation

Consider multidimensional wave equation

$$u_{tt} - c^2 \Delta u = 0. \tag{2.7.1}$$

Recall that  $\Delta = \nabla \cdot \nabla = \partial_x^2 + \partial_y^2 + \partial_z^2$  (the number of terms depends on dimension). Multiplying by  $u_t$  we get in the left-hand expression

$$\begin{aligned} u_t u_{tt} - c^2 u_t \nabla^2 u &= \partial_t \left( \frac{1}{2} u_t^2 \right) + \nabla \cdot \left( -c^2 u_t \nabla u \right) + c^2 \nabla u_t \cdot \nabla u \\ &= \partial_t \left( \frac{1}{2} u_t^2 + \frac{1}{2} c^2 |\nabla u|^2 \right) + \nabla \cdot \left( -c^2 u_t \nabla u \right). \end{aligned}$$

So we arrive to

$$\partial_t \left( \frac{1}{2} u_t^2 + \frac{1}{2} c^2 |\nabla u|^2 \right) + \nabla \cdot \left( -c^2 u_t \nabla u \right). \quad (2.7.2)$$

This is *energy conservation law in the differential form*.

Here

$$e = \left( \frac{1}{2} u_t^2 + \frac{1}{2} c^2 |\nabla u|^2 \right) \quad (2.7.3)$$

is a *density of energy* and

$$\mathbf{S} = -c^2 u_t \nabla u \quad (2.7.4)$$

is a vector of *energy flow*.

Then if we fix a volume (or an area in 2D case, or just an interval in 1D case)  $V$  and introduce a full energy in  $V$  at moment  $t$

$$E_V(t) = \iiint_V \left( \frac{1}{2} u_t^2 + \frac{1}{2} c^2 |\nabla u|^2 \right) dV \quad (2.7.5)$$

then

$$E_V(t_2) - E_V(t_1) + \int_{t_1}^{t_2} dt \iint_{\Sigma} \mathbf{S} \cdot \mathbf{n} d\sigma = 0 \quad (2.7.6)$$

where  $\Sigma$  is the surface bounding  $V$ ,  $d\sigma$  is an element of the surface area, and  $\mathbf{n}$  is a unit exterior normal to  $\Sigma$ .

## 2.7.2 Energy integral: Maxwell equations

Similarly, *Maxwell equations* without charges and currents are

$$\varepsilon \mathbf{E}_t = c \nabla \times \mathbf{H}, \quad (2.7.7)$$

$$\mu \mathbf{H}_t = -c \nabla \times \mathbf{E}, \quad (2.7.8)$$

$$\nabla \cdot \varepsilon \mathbf{E} = \nabla \cdot \mu \mathbf{H} = 0. \quad (2.7.9)$$

Here  $\mathbf{E}$ ,  $\mathbf{H}$  are intensities of electric and magnetic field respectively,  $c$  is the speed of light in the vacuum,  $\varepsilon$  and  $\mu$  are dielectric and magnetic characteristics of the material ( $\varepsilon \geq 1$ ,  $\mu \geq 1$  and  $\varepsilon = \mu = 1$  in the vacuum).

Multiplying (taking an inner product) (2.7.7) by  $\mathbf{E}$  and (2.7.8) by  $\mathbf{H}$  and adding we arrive to

$$\partial_t \left( \frac{1}{2} \varepsilon |\mathbf{E}|^2 + \frac{1}{2} \mu |\mathbf{H}|^2 \right) = c (\mathbf{E} \cdot (\nabla \times \mathbf{H}) - \mathbf{H} \cdot (\nabla \times \mathbf{E})) = -c \nabla \cdot (\mathbf{E} \times \mathbf{H})$$

where the last equality follows from vector calculus.

Then

$$\partial_t \left( \frac{1}{2} \varepsilon |\mathbf{E}|^2 + \frac{1}{2} \mu |\mathbf{H}|^2 \right) + \nabla \cdot (c \mathbf{E} \times \mathbf{H}) = 0. \quad (2.7.10)$$

In the theory of electromagnetism

$$e = \frac{1}{2} (\varepsilon |\mathbf{E}|^2 + \mu |\mathbf{H}|^2) \quad (2.7.11)$$

is again *density of energy* and

$$\mathbf{S} = c \mathbf{E} \times \mathbf{H} \quad (2.7.12)$$

is a vector of *energy flow* (aka *Poynting vector*).

*Remark 2.7.1.* (a)  $\frac{c}{\sqrt{\mu\varepsilon}}$  is the speed of light in the given material.

(b) In inhomogeneous material  $\varepsilon$  and  $\mu$  depend on  $(x, y, z)$ ; in anisotropic material (f.e. crystal)  $\varepsilon$  and  $\mu$  are matrices and then  $e = \frac{1}{2} (\varepsilon \mathbf{E} \cdot \mathbf{E} + \mu \mathbf{H} \cdot \mathbf{E})$ .

### 2.7.3 Elasticity equations

Elasticity equations in homogeneous isotropic material are

$$\mathbf{u}_{tt} = 2\mu \Delta \mathbf{u} + \lambda \nabla (\nabla \cdot \mathbf{u}) \quad (2.7.13)$$

where  $\mathbf{u}$  is a *displacement* and  $\lambda > 0$ ,  $\mu > 0$  are *Lamé parameters*.

*Problem 2.7.1.* Multiplying (taking an inner product) (2.7.13) by  $\mathbf{u}_t$  write conservation law in the differential form. What are  $e$  and  $\mathbf{S}$ ?

### 2.7.4 Miscellaneous

**Conservation Laws** More examples of the *conservation laws in the differential form* could be found in Problems to Section 2.7 and Section 14.1.

**Applications of energy Integral** Energy integral can be used to prove the Section 9.2 and, combined with the *functional-analytical methods* (which means methods of Analysis III a.k.a Real Analysis) to prove also the *existence* and the *well-posedness*.

### Problems to Section 2.7

*Problem 1.* For equation

$$u_{tt} - c^2 u_{xx} + f(u) = 0, \quad x > 0$$

prove energy conservation law

$$E(t) = \frac{1}{2} \int_0^\infty (u_t^2 + c^2 u_x^2 + F(u)) dx$$

under Dirichlet ( $u|_{x=0} = 0$ ) or Neumann ( $u_x|_{x=0} = 0$ ) boundary condition; here  $F$  is a primitive of  $f$ .

*Problem 2.* For beam equation

$$u_{tt} + K u_{xxxx} = 0, \quad x > 0,$$

prove energy conservation law

$$E(t) = \frac{1}{2} \int_0^\infty (u_t^2 + K u_{xx}^2) dx$$

under each of the pair of the boundary conditions:

$$\begin{aligned} u|_{x=0} &= u_x|_{x=0} = 0; \\ u|_{x=0} &= u_{xxx}|_{x=0} = 0; \\ u_x|_{x=0} &= u_{xx}|_{x=0} = 0. \end{aligned}$$

*Problem 3.* (a) For problem

$$\begin{cases} u_{tt} - c^2 u_{xx} = 0, & x > 0, \\ (\alpha_0 u_x + \alpha_1 u)|_{x=0} = 0 \end{cases}$$

find energy conservation law

$$E(t) = \frac{1}{2} \int_0^\infty (u_t^2 + c^2 u_x^2) dx + \frac{1}{2} a u(0)^2$$

(you need to calculate  $a$ ).

(b) For problem

$$\begin{cases} u_{tt} - c^2 u_{xx} = 0, & 0 < x < l, \\ (\alpha_0 u_x + \alpha_1 u)|_{x=0} = 0, \\ (\beta_0 u_x - \beta_1 u)|_{x=l} = 0 \end{cases}$$

find energy conservation law

$$E(t) = \frac{1}{2} \int_0^\infty (u_t^2 + c^2 u_x^2) dx + \frac{1}{2} a u(0)^2 + \frac{1}{2} b u(l)^2$$

(you need to calculate  $a, b$ ).

*Problem 4.* For problem

$$\begin{cases} u_{tt} - c^2 u_{xx} = 0, & x > 0, \\ (u_x - i\alpha u_t)|_{x=0} = 0 \end{cases}$$

with real  $\alpha$  prove energy conservation law

$$E(t) = \frac{1}{2} \int_0^\infty (|u_t|^2 + c^2 |u_x|^2) dx.$$

*Problem 5.* Consider Problem 2

$$\begin{cases} u_{tt} - c_1^2 u_{xx} = 0, & t > 0, x > 0, \\ u_{tt} - c_2^2 u_{xx} = 0, & t > 0, x < 0, \\ u|_{t=0} = \phi(x), & u_t|_{t=0} = c_1 \phi'(x) & x > 0, \\ u|_{t=0} = 0, & u_t|_{t=0} = 0, & x < 0, \\ u|_{x=+0} = \alpha u|_{x=-0}, & u_x|_{x=+0} = \beta u_x|_{x=-0} & t > 0 \end{cases}$$

Let

$$E_1(t) = \frac{m_1}{2} \int_0^\infty (u_t^2 + c_1^2 u_x^2) dx,$$

$$E_2(t) = \frac{m_2}{2} \int_{-\infty}^0 (u_t^2 + c_2^2 u_x^2) dx.$$

(a) Find ratio  $m_1 : m_2$  such that  $E(t) = E_1(t) + E_2(t)$  is conserved.

- (b) In this case prove that if  $\phi(x) = 0$  for  $x > L$  then for  $t > L/c_1$ :  
 $E_1(t) = k_1 E(0)$  and  $E_2(t) = k_2 E(0)$ .

Calculate  $k_1, k_2$  and prove that  $k_1 + k_2 = 1$ .

*Problem 6.* Consider the PDE with boundary conditions:

$$\begin{aligned} u_{tt} - c^2 u_{xx} + a^2 u &= 0, & x > 0, \\ u|_{x=0} &= 0 \end{aligned}$$

with  $c > 0, a > 0$ . Consider

$$E(t) := \frac{1}{2} \int_0^\infty \left( t(u_t^2 + c^2 u_x^2 + a^2 u^2) + 2x u_t u_x \right) dx$$

and check, what *exactly* holds:

$$(a) \quad \frac{dE}{dt} \leq 0, \quad (b) \quad \frac{dE}{dt} = 0, \quad (c) \quad \frac{dE}{dt} \geq 0.$$

*Hint.* Calculate  $\frac{dE}{dt}$ , substitute  $u_{tt}$  from equation and integrate by parts with respect to  $x$  as needed, taking into account boundary condition).

*Problem 7.* Consider the PDE with boundary conditions:

$$\begin{aligned} u_{tt} - c^2 u_{xx} - a u_t &= 0, & 0 < x < L, \\ (u_x + b u_t)|_{x=0} &= 0, \\ u|_{x=L} &= 0, \end{aligned}$$

where  $a > 0, b > 0$  are constant. Consider

$$E(t) := \frac{1}{2} \int_0^L (u_t^2 + c^2 u_x^2) dx$$

and check, what *exactly* holds:

$$(a) \quad \frac{dE}{dt} \leq 0, \quad (b) \quad \frac{dE}{dt} = 0, \quad (c) \quad \frac{dE}{dt} \geq 0.$$

*Hint.* Calculate  $\frac{dE}{dt}$ , substitute  $u_{tt}$  from equation and integrate by parts with respect to  $x$  as needed, taking into account boundary conditions .

*Problem 8.* Consider the PDE with boundary conditions:

$$\begin{aligned} u_{tt} - c^2 u_{xx} + au_t &= 0, & 0 < x < L, \\ u|_{x=0} &= 0, \\ u_x|_{x=L} &= 0, \end{aligned}$$

where  $a > 0$  are constant. Consider

$$E(t) := \frac{1}{2} e^{2at} \int_0^L (u_t^2 + c^2 u_x^2) dx$$

and check, what *exactly* holds:

$$(a) \frac{dE}{dt} \leq 0, \quad (b) \frac{dE}{dt} = 0, \quad (c) \frac{dE}{dt} \geq 0.$$

*Hint.* Calculate  $\frac{dE}{dt}$ , substitute  $u_{tt}$  from equation and integrate by parts with respect to  $x$  as needed, taking into account boundary conditions.

*Problem 9.* Consider the PDE with boundary conditions:

$$\begin{aligned} u_{tt} - c^2 u_{xx} &= 0, & x > 0, \\ u|_{x=0} &= 0. \end{aligned}$$

Consider

$$E(t) := \frac{1}{2} \int_0^\infty \left( t(u_t^2 + c^2 u_x^2) + 2xu_t u_x \right) dx$$

and check, what *exactly* holds:

$$(a) \frac{dE}{dt} \leq 0, \quad (b) \frac{dE}{dt} = 0, \quad (c) \frac{dE}{dt} \geq 0.$$

*Hint.* Calculate  $\frac{dE}{dt}$ , substitute  $u_{tt}$  from equation and integrate by parts with respect to  $x$  as needed, taking into account boundary condition.

## 2.8 Hyperbolic first order systems with one spatial variable

### 2.8.1 Definition

We consider system

$$EU_t + AU_x + BU = F \quad (2.8.1)$$

where  $E, A, B$  are  $n \times n$ -matrices,  $U$  is unknown  $n$ -vector (column) and  $F$  is known  $n$ -vector (column).

### 2.8.2 Completely separable systems

Assume that  $E$  and  $A$  are constant matrices,  $E$  is non-degenerate,  $E^{-1}A$  has real eigenvalues  $\lambda_1, \dots, \lambda_n$  and is diagonalizable:  $E^{-1}A = Q^{-1}\Lambda Q$  with  $\Lambda = \text{diag}(\lambda_1, \dots, \lambda_n)$  (diagonal matrix with  $\lambda_1, \dots, \lambda_n$  on the diagonal).

Then substituting  $U = QV$  (or  $V = Q^{-1}U$ ) we have

$$QV_t + E^{-1}AQV_x + E^{-1}BQV = E^{-1}F$$

or

$$V_t + \Lambda V_x + Q^{-1}E^{-1}BQV = Q^{-1}E^{-1}F. \quad (2.8.2)$$

In particular, if  $Q^{-1}E^{-1}BQ$  is also a diagonal matrix:  $Q^{-1}E^{-1}BQ = \text{diag}(\alpha_1, \dots, \alpha_n)$  (which is the case provided  $B = 0$ ) we have  $n$  separate equations

$$V_{j,t} + \lambda_j V_{j,x} + \alpha_j V_j = f_j \quad (2.8.3)$$

and we can apply the theory of Section 2.1.

**Definition 2.8.1.** Lines  $x - \lambda_j t = \text{const}$  are *characteristics*,  $V_j$  are called *Riemannian invariants*. If  $\alpha_j = 0$ ,  $f_j = 0$  these Riemannian invariants are constant along characteristics.

### 2.8.3 IVP (Cauchy problem)

Consider Cauchy problem:  $U|_t = 0 = G(x)$ ,  $x \in \mathbb{R}$ .

**Proposition 2.8.1.** (i) Let  $E = I$ ,  $A = \Lambda$  (already diagonalized) and  $B = 0$ . Then  $U_j$  at point  $P$  is defined by  $G_j(P_j)$  and  $F_j$  on a segment of characteristics connecting  $P$  and  $P_j$  where  $P_j$  is an intersection of  $x - \lambda_j t = \text{const}$  passing through  $P$  and  $\{t = 0\}$ ; ( $j = 1, \dots, n$ ).



(ii) Let  $B = 0$ . Then  $U$  at point  $P$  is defined by  $G(P_j)$  and by  $F$  on segments of characteristics connecting  $P$  and  $P_j$ ; ( $j = 1, \dots, n$ ).

*Proof.* The first statement is obvious and the second follows from it. Note that transform by  $Q$  messes up components of  $U$ , and  $F$ , and  $G$ .  $\square$

### 2.8.4 2.8.4. IBVP

Consider now equations (2.8.3) in domain  $\Omega = \{t > 0, x > \mu t\}$  assuming that the lateral boundary  $\Gamma = \{x = \mu t, t > 0\}$  is not a characteristic, i.e.  $\mu$  is not one of the numbers  $\lambda_1, \dots, \lambda_n$ . Then (renumbering Riemannian invariants if necessary) we have

$$\lambda_1 \leq \dots \leq \lambda_m < \mu < \lambda_{m+1} \leq \dots \leq \lambda_n. \quad (2.8.4)$$

Then with equation in  $\Omega$  and initial data on  $\{t = 0, x > 0\}$  we can find  $V_1, \dots, V_m$  everywhere in  $\Omega$  and thus on  $\Gamma$ ; we call  $V_1, \dots, V_m$  *incoming Riemannian invariants*. On the other hand, we define this way  $V_{m+1}, \dots, V_n$  only as  $x \geq \lambda_{m+1}, \dots, \lambda_n$  respectively and therefore not on  $\Gamma$ ; we call them *outgoing Riemannian invariants*.

To define *outgoing Riemannian invariants*  $V_{m+1}, \dots, V_n$  on  $\Gamma$  and thus in the rest of  $\Omega$  we need boundary condition  $CU|_{\Gamma} = H$  where  $C$  is  $(n-m) \times n$ -matrix and  $H = H(t)$  is  $(n-m)$ -vector.

Indeed we need as many equations as outgoing Riemannian invariants. However it is not sufficient. We need also to assume that the following *non-degeneracy* assumption is fulfilled:  $(n-m) \times (n-m)$ -matrix  $C'$  obtained from  $C$  by selecting last  $(n-m)$  columns (corresponding to outgoing Riemannian invariants) is non-degenerate.

### 2.8.5 Compatibility condition

The solution is continuous if and only if *compatibility condition*  $CG(0) = H(0)$ . *Think why*. If this condition fails,  $U$  is discontinuous (has jumps) along characteristics going into  $\Omega$  from the corner point  $(0, 0)$ .

But even if solution is continuous it is not necessarily continuously differentiable (one needs more compatibility conditions for this); even more compatibility conditions for  $U$  be twice continuously differentiable etc.

*Problem 2.8.1.* (a) Prove compatibility condition  $CG(0) = H(0)$  for continuity of solution  $U$ ;

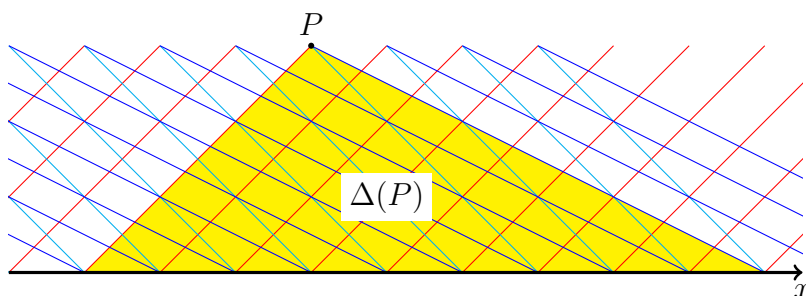

(b) Derive a compatibility condition for continuity of the first derivatives  $U_t, U_x$  of the solution;

(c) Derive a compatibility condition for continuity of the second derivatives  $U_{tt}, U_{tx}, U_{xx}$  of the solution.

### 2.8.6 General case

What happens if  $Q^{-1}E^{-1}BQ$  is not a diagonal matrix? More generally, consider  $E = E(x, t)$ ,  $A = A(x, t)$ ,  $B = B(x, t)$ . Then assuming that  $E^{-1}A$  is *smooth diagonalizable* (that means one can select  $Q = Q(x, t)$  a smooth matrix; this is the case provided  $\lambda_1, \dots, \lambda_n$  are real and distinct at every point) we have

$$V_t + \Lambda V + Q^{-1}(Q_t + AQ_x + CQ)V = Q^{-1}F; \quad (2.8.5)$$

so while main part of system broke into separate equations, they are entangled through lower order terms.

**IVP** Then main conclusions are the same:

For Cauchy problem consider point  $P$  and a triangle  $\Delta(P)$  formed by two characteristics: the leftmost and the rightmost going back in time and by initial line. This triangle (curvilinear if  $\lambda_j$  are not constant) is the *domain of dependence of P*.

**IBVP** Again we need to assume that  $\Gamma$  (which could be a smooth curve rather than the straight ray) is non-characteristic at each point, then the

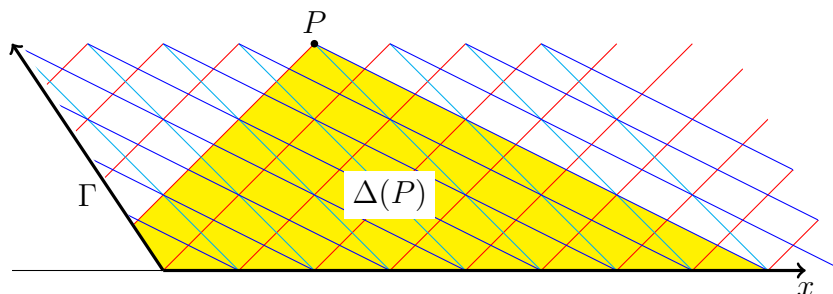

numbers of incoming and outgoing Riemannian invariants remain constant along  $\Gamma$  and we need impose as many boundary condition as there are outgoing Riemannian invariants and we need to impose non-degeneracy condition in each point of  $\Gamma$ .

### Problems to Section 2.8

*Problem 1.* Find the characteristics and write down the general solutions to the systems  $U_u + AU_x = 0$  with

$$\begin{aligned}
 A &= \begin{pmatrix} 2 & 3 \\ 3 & 2 \end{pmatrix}, & A &= \begin{pmatrix} 2 & -3 \\ 1 & -2 \end{pmatrix}, \\
 A &= \begin{pmatrix} 1 & -1 \\ 2 & 4 \end{pmatrix}, & A &= \begin{pmatrix} -1 & -1 \\ 2 & -4 \end{pmatrix}, \\
 A &= \begin{pmatrix} 3 & 2 \\ 0 & -1 \end{pmatrix}, & A &= \begin{pmatrix} 3 & 0 \\ 2 & -1 \end{pmatrix}.
 \end{aligned}$$

*Problem 2.* For each system from Problem 1 in  $\{x > 0, t > 0\}$  determine which of the following IVBPs is well-posed and find solution ( $U = \begin{pmatrix} u \\ v \end{pmatrix}$ ):

$$\begin{aligned}
 u|_{t=0} &= f(x), v|_{t=0} = g(x); & u|_{x=0} &= \phi(t), \\
 u|_{t=0} &= f(x), v|_{t=0} = g(x); & u|_{x=0} &= \phi(t), v|_{x=0} = \psi(t) \\
 u|_{t=0} &= f(x), v|_{t=0} = g(x); & &
 \end{aligned}$$

*Problem 3.* Find the characteristics and write down the general solutions to the systems  $U_t + AU_x = 0$  with

$$\begin{aligned}
 A &= \begin{pmatrix} 3 & 2 & 1 \\ 0 & 2 & 1 \\ 0 & 0 & 1 \end{pmatrix}, & A &= \begin{pmatrix} 3 & 2 & 1 \\ 0 & 2 & 1 \\ 0 & 0 & -1 \end{pmatrix}, \\
 A &= \begin{pmatrix} 3 & 2 & 1 \\ 0 & -2 & 1 \\ 0 & 0 & -1 \end{pmatrix}, & A &= \begin{pmatrix} -3 & 2 & 1 \\ 0 & -2 & 1 \\ 0 & 0 & -1 \end{pmatrix}, \\
 A &= \begin{pmatrix} 1 & 2 & 3 \\ 2 & 0 & 3 \\ 2 & 3 & 0 \end{pmatrix}.
 \end{aligned}$$

*Problem 4.* For each system from Problem 3 in  $\{x > 0, t > 0\}$  determine which of the following IVBPs is well-posed and find solution  $(U = \begin{pmatrix} u \\ v \\ w \end{pmatrix})$ :

$$\begin{aligned}
 &u|_{t=0} = f(x), v|_{t=0} = g(x), w|_{t=0} = h(x); \\
 &\begin{cases} u|_{t=0} = f(x), v|_{t=0} = g(x), w|_{t=0} = h(x), \\ u|_{x=0} = \phi(t); \end{cases} \\
 &\begin{cases} u|_{t=0} = f(x), v|_{t=0} = g(x), w|_{t=0} = h(x), \\ u|_{x=0} = \phi(t), v|_{x=0} = \psi(t); \end{cases} \\
 &\begin{cases} u|_{t=0} = f(x), v|_{t=0} = g(x), w|_{t=0} = h(x), \\ u|_{x=0} = \phi(t), v|_{x=0} = \psi(t), w|_{x=0} = \chi(t). \end{cases}
 \end{aligned}$$

# Chapter 3

## Heat equation in 1D

In this Chapter we consider 1-dimensional heat equation (also known as diffusion equation). Instead of more standard Fourier method (which we will postpone a bit) we will use the method of *self-similar solutions*.

### 3.1 Heat equation

#### 3.1.1 Introduction

*Heat equation* which is in its simplest form

$$u_t = ku_{xx} \tag{3.1.1}$$

is another classical equation of mathematical physics and it is very different from wave equation. This equation describes also a diffusion, so we sometimes will refer to it as *diffusion equation*. See Subsection 1.4.2).

It also describes random walks (see Project “Project: Walk problem”).

#### 3.1.2 Self-similar solutions

We want to solve IVP for equation (3.1.1) with  $t > 0$ ,  $-\infty < x < \infty$ . Let us plug

$$u_{\alpha,\beta,\gamma}(x,t) := \gamma u(\alpha x, \beta t). \tag{3.1.2}$$

**Proposition 3.1.1.** *If  $u$  satisfy equation (3.1.1) then  $u_{\alpha,\beta,\gamma}$  also satisfies this equation provided  $\beta = \alpha^2$ .*

*Proof.* is just by calculation. Note that  $\beta = \alpha^2$  because one derivative with respect to  $t$  is “worth” of two derivatives with respect to  $x$ .  $\square$

We impose another assumption:

*Condition 3.1.1.* Total heat energy

$$I(t) := \int_{-\infty}^{\infty} u(x, t) dx \quad (3.1.3)$$

is finite and does not depend on  $t$ .

The second part is due to the first one. Really (not rigorous) integrating

$$u_t = ku_{xx} \quad (1)$$

by  $x$  from  $-\infty$  to  $+\infty$  and assuming that  $u_x(\pm\infty) = 0$  we see that  $\partial_t I(t) = 0$ .

Note that  $\int_{-\infty}^{\infty} u_{\alpha, \beta, \gamma} dx = \gamma |\alpha|^{-1} \int_{-\infty}^{\infty} u dx$  and to have them equal we should take  $\gamma = |\alpha|$  (actually we restrict ourselves by  $\alpha > 0$ ). So (3.1.2) ( $u_{\alpha, \beta, \gamma}(x, t) = \gamma u(\alpha x, \beta t)$ ) becomes

$$u_{\alpha}(x, t) = \alpha u(\alpha x, \alpha^2 t). \quad (3.1.4)$$

This is *transformation of similarity*. Now we are looking for a *self-similar* solution of (3.1.1) i.e. solution such that  $u_{\alpha}(x, t) = u(x, t)$  for all  $\alpha > 0, x, t > 0$ . So we want

$$u(x, t) = \alpha u(\alpha x, \alpha^2 t) \quad \forall \alpha > 0, t > 0, x. \quad (3.1.5)$$

We want to get rid off one of variables; so taking  $\alpha = t^{-\frac{1}{2}}$  we get

$$u(x, t) = t^{-\frac{1}{2}} u(t^{-\frac{1}{2}} x, 1) = t^{-\frac{1}{2}} \phi(t^{-\frac{1}{2}} x) \quad (3.1.6)$$

with  $\phi(\xi) := u(\xi, 1)$ . Equality (3.1.6) is equivalent to (3.1.5).

Now we need to plug  $u(x, t) = t^{-\frac{1}{2}} \phi(t^{-\frac{1}{2}} x)$  into equation (3.1.1). Note that

$$\begin{aligned} u_t &= -\frac{1}{2} t^{-\frac{3}{2}} \phi(t^{-\frac{1}{2}} x) + t^{-\frac{1}{2}} \phi'(t^{-\frac{1}{2}} x) \times \left(-\frac{1}{2} t^{-\frac{3}{2}} x\right) = \\ &= -\frac{1}{2} t^{-\frac{3}{2}} \left(\phi(t^{-\frac{1}{2}} x) + t^{-\frac{1}{2}} x \phi'(t^{-\frac{1}{2}} x)\right) \end{aligned}$$

and

$$u_x = t^{-1}\phi'(t^{-\frac{1}{2}}x), \quad u_{xx} = t^{-\frac{3}{2}}\phi''(t^{-\frac{1}{2}}x).$$

Plugging into  $u_t = ku_{xx}$ , multiplying by  $t^{\frac{3}{2}}$  and plugging  $t^{-\frac{1}{2}}x = \xi$  we arrive to

$$-\frac{1}{2}(\phi(\xi) + \xi\phi'(\xi)) = k\phi''(\xi). \quad (3.1.7)$$

Good news: it is ODE. Really good news:  $\phi(\xi) + \xi\phi'(\xi) = (\xi\phi(\xi))'$ . Then integrating we get

$$-\frac{1}{2}\xi\phi(\xi) = k\phi'(\xi). \quad (3.1.8)$$

*Remark 3.1.1.* Sure there should be  $+C$  but we are looking for a solution fast decaying with its derivatives at  $\infty$  and it implies that  $C = 0$ .

Separating in (3.1.8) variables and integrating we get

$$\frac{d\phi}{\phi} = -\frac{1}{2k}\xi d\xi \implies \log(\phi) = -\frac{1}{4k}\xi^2 + \log(c) \implies \phi(\xi) = ce^{-\frac{1}{4k}\xi^2}$$

and plugging into (3.1.6) (which is  $u(x, t) = t^{-\frac{1}{2}}\phi(t^{-\frac{1}{2}}x)$ ) we arrive to

$$u(x, t) = \frac{1}{2\sqrt{\pi kt}}e^{-\frac{x^2}{4kt}}. \quad (3.1.9)$$

*Remark 3.1.2.* We took  $c = \frac{1}{2\sqrt{\pi k}}$  to satisfy  $I(t) = 1$ .

Really,

$$I(t) = c \int_{-\infty}^{+\infty} t^{-\frac{1}{2}}e^{-\frac{x^2}{4kt}} dx = c\sqrt{4k} \int_{-\infty}^{+\infty} e^{-z^2} dz = 2c\sqrt{k\pi}$$

where we changed variable  $x = z/\sqrt{2kt}$  and used the equality

$$J = \int_{-\infty}^{+\infty} e^{-x^2} dx = \sqrt{\pi}. \quad (3.1.10)$$

To prove (3.1.10) just note that

$$J^2 = \int_{-\infty}^{+\infty} \int_{-\infty}^{+\infty} e^{-x^2} \times e^{-y^2} dx dy = \int_0^{2\pi} d\theta \int_0^{\infty} e^{-r^2} r dr = \pi$$

where we used polar coordinates; since  $J > 0$  we get (3.1.10).

*Remark 3.1.3.* Solution which we got is a very important one. However we have a problem understanding what is  $u|_{t=0^+}$  as  $u(x, t) \rightarrow 0$  as  $t \rightarrow 0^+$  and  $x \neq 0$  but  $u(x, t) \rightarrow \infty$  as  $t \rightarrow 0^+$  and  $x = 0$  and  $\int_{-\infty}^{\infty} u(x, t) dx = 1$ .

In fact  $u|_{t=0^+} = \delta(x)$  which is *Dirac  $\delta$ -function* which actually is not an ordinary function but a *distribution* (see [Section 11.1](#)).

Distributions play important role in the modern Analysis and applications, in particular, to Physics.

To work around this problem we consider

$$U(x, t) = \int_{-\infty}^x u(x, t) dx. \quad (3.1.11)$$

We claim that

**Proposition 3.1.2.** (i)  $U(x, t)$  also satisfies equation (3.1.1).

(ii)  $U(x, 0^+) = \theta(x) = \begin{cases} 0 & x < 0, \\ 1 & x > 0 \end{cases}$  is a *Heaviside step function*.

*Proof.* Plugging  $u = U_x$  into (3.1.1) we see that  $(U_t - kU_{xx})_x = 0$  and then  $(U_t - kU_{xx}) = \Phi(t)$ . However one can see easily that as  $x \rightarrow -\infty$   $U$  is fast decaying with all its derivatives and therefore  $\Phi(t) = 0$  and Statement (i) is proven.

Note that

$$U(x, t) = \frac{1}{\sqrt{\pi}} \int_{-\infty}^{\frac{x}{\sqrt{4kt}}} e^{-z^2} dz =: \frac{1}{2} + \frac{1}{2} \operatorname{erf}\left(\frac{x}{\sqrt{4kt}}\right) \quad (3.1.12)$$

with

$$\operatorname{erf}(z) := \frac{2}{\sqrt{\pi}} \int_0^z e^{-z^2} dz \quad (\operatorname{erf})$$

and that an upper limit in integral tends to  $\mp\infty$  as  $t \rightarrow 0^+$  and  $x \leq 0$ . Then since an integrand is very fast decaying at  $\mp\infty$  we using (3.1.10) arrive to Statement (ii).  $\square$

*Remark 3.1.4.* (a) One can construct  $U(x, t)$  as a self-similar solution albeit with  $\gamma = 1$ .

(b) We can avoid analysis of  $U(x, t)$  completely just by noting that  $u(x, t)$  is a  $\delta$ -sequence as  $t \rightarrow 0^+$ :  $u(x, t) \rightarrow 0$  for all  $x \neq 0$  but  $\int_{-\infty}^{\infty} u(x, t) dx = 1$ .



Consider now a smooth function  $g(x)$ ,  $g(-\infty) = 0$  and note that

$$g(x) = \int_{-\infty}^{\infty} \theta(x-y)g'(y) dy. \quad (3.1.13)$$

Really, the r.h.e. is  $\int_{-\infty}^x g'(y) dy = g(x) - g(-\infty)$ .

Also note that  $U(x-y, t)$  solves the IVP with initial condition  $U(x-y, 0^+) = \theta(x-y)$ . Therefore

$$u(x, t) = \int_{-\infty}^{\infty} U(x-y, t)g'(y) dy$$

solves the IVP with initial condition  $u(x, 0^+) = g(y)$ .

Integrating by parts with respect to  $y$  we arrive to

$$u(x, t) = \int_{-\infty}^{\infty} U_x(x-y, t)g(y) dy$$

and finally to

$$u(x, t) = \int_{-\infty}^{\infty} G(x-y, t)g(y) dy \quad (3.1.14)$$

with

$$G(x-y, t) := \frac{1}{2\sqrt{k\pi t}} e^{-\frac{(x-y)^2}{4kt}}. \quad (3.1.15)$$

So we have proven:

**Theorem 3.1.3.** *Formulae (3.1.14)–(3.1.15) give us a solution of*

$$u_t = ku_{xx} \quad -\infty < x < \infty, t > 0, \quad (3.1.16)$$

$$u|_{t=0} = g(x). \quad (3.1.17)$$

*Remark 3.1.5.* We will recreate the same formulae in Section 5.3 using *Fourier transform*.

*Example 3.1.1.* Find the solution  $u(x, t)$  to

$$u_t = 4u_{xx} \quad -\infty < x < \infty, t > 0,$$

$$u|_{t=0} = \begin{cases} 1 - |x| & |x| < 1, \\ 0 & |x| \geq 1, \end{cases}$$

$$\max |u| < \infty.$$

*Solution.*

$$\begin{aligned} u(x, t) &= \frac{1}{\sqrt{16\pi t}} \int_{-\infty}^{\infty} e^{-\frac{1}{16t}(x-y)^2} g(y) dy \\ &= \frac{1}{\sqrt{16\pi t}} \left( \int_{-1}^0 e^{-\frac{1}{16t}(x-y)^2} (1+y) dy + \int_0^1 e^{-\frac{1}{16t}(x-y)^2} (1-y) dy \right). \end{aligned}$$

Plugging  $y = x + 4z\sqrt{t}$  and changing limits

$$\begin{aligned} u(x, t) &= \frac{1}{\sqrt{\pi}} \left( \int_{-(x+1)/4\sqrt{t}}^{-x/4\sqrt{t}} e^{-z^2} (1+x+4z\sqrt{t}) dz \right. \\ &\quad \left. + \int_{-x/4\sqrt{t}}^{-(x-1)/4\sqrt{t}} e^{-z^2} (1-x-4z\sqrt{t}) dz \right) \end{aligned}$$

we evaluate integrals of the terms without factor  $z$  as erf functions and terms with factor  $z$  we simply integrate resulting in

$$\begin{aligned} u(x, t) &= \frac{1}{2}(1+x) \left( \operatorname{erf}\left(\frac{x+1}{4\sqrt{t}}\right) - \operatorname{erf}\left(\frac{x}{4\sqrt{t}}\right) \right) \\ &\quad + \frac{1}{2}(1-x) \left( \operatorname{erf}\left(\frac{x}{4\sqrt{t}}\right) - \operatorname{erf}\left(\frac{x-1}{4\sqrt{t}}\right) \right) \\ &\quad + \frac{2\sqrt{t}}{\sqrt{\pi}} \left( e^{-z^2} \Big|_{z=x/4\sqrt{t}}^{z=(x+1)/4\sqrt{t}} + e^{-z^2} \Big|_{z=x/4\sqrt{t}}^{z=(x-1)/4\sqrt{t}} \right). \end{aligned}$$

□

### 3.1.3 Inhomogeneous right-hand expression

Consider instead problem with the right-hand expression

$$u_t = ku_{xx} + f(x, t) \quad -\infty < x < \infty, t > 0, \quad (3.1.18)$$

$$u|_{t=0} = g(x). \quad (3.1.17)$$

By Duhamel principle the contribution of this right-hand expression is

$$\int_0^t \int G(x-y, t-\tau) f(y, \tau) dy d\tau \quad (3.1.19)$$

Indeed, Duhamel integral (2.5.8)

$$u(x, t) = \int_0^t U(x, t, \tau) d\tau \quad (2.5.8)$$

remains except now auxiliary function  $U(x, t; \tau)$  satisfies heat equation (3.1.1) with initial condition  $U_t|_{t=\tau} = f(x, \tau)$ .

One can prove it exactly as in Subsection 2.5.2.

*Exercise 3.1.1.* Do it by yourself!

Therefore we arrive to

**Theorem 3.1.4.** *Solution of problem (3.1.18)–(3.1.17) is given by*

$$u(x, t) = \int_0^t \int_{-\infty}^{\infty} G(x - y, t - \tau) f(y, \tau) dy d\tau + \int_{-\infty}^{\infty} G(x - y, t) g(y) dy. \quad (3.1.20)$$

Here the first term expression solves IVP with the right-hand expression  $f(x, t)$  and initial condition  $u(x, 0) = 0$  and the second term solves IVP with the right-hand expression 0 and initial condition  $u(x, 0) = g(x)$ .

**Theorem 3.1.5.** *Let  $u$  satisfy (3.1.18) in domain  $\Omega \subset \mathbb{R}_t \times \mathbb{R}_x$  with  $f \in C^\infty(\Omega)$ . Then  $u \in C^\infty(\Omega)$ .*

We will prove it later.

*Remark 3.1.6.* (a) So far we have not discussed the uniqueness of the solution. In fact, as formulated, the solution is not unique. But do not worry: “extra solutions” are so irregular (fast growing and oscillating) at infinity that they have no “physical sense”. We discuss it later.

(b) IVP in the direction of negative time is ill-posed. Indeed, if  $f \in C^\infty$  it follows from Theorem 3.1.5 that solution cannot exist for  $t \in (-\epsilon, 0]$  unless  $g \in C^\infty$  (which is only necessary, but not sufficient).

(c) Domain of dependence for  $(x, t)$  is  $\{(x', t') : -\infty < x' < \infty, 0 < t' < t\}$  and the propagation speed is infinite! No surprise: heat equation is not relativistic!

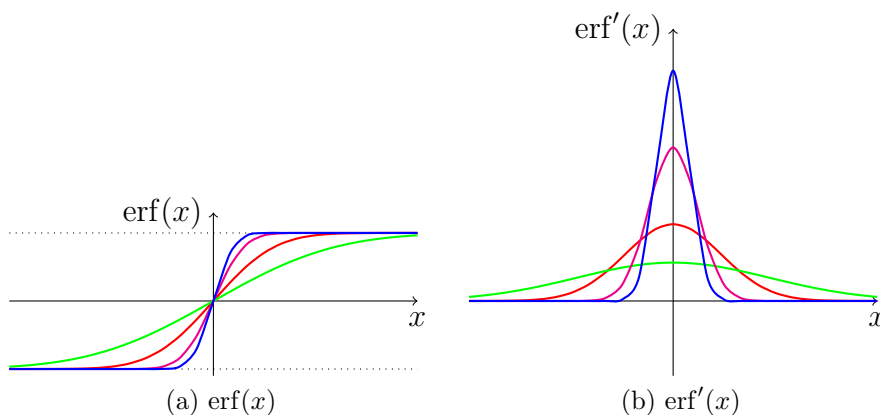

### 3.1.4 References

Plots:

- (a) [Visual Example \(animation\)](#)
- (b) [erf function on Wolfram alpha](#)
- (c) [erf derivative on Wolfram alpha](#)

## 3.2 Heat equation (miscellaneous)

### 3.2.1 Heat equation on half-line

In the previous lecture we considered heat equation

$$u_t = ku_{xx} \quad (3.2.1)$$

with  $x \in \mathbb{R}$  and  $t > 0$  and derived formula

$$u(x, t) = \int_{-\infty}^{\infty} G(x, y, t)g(y) dy. \quad (3.2.2)$$

with

$$G(x, y, t) = G_0(x - y, t) := \frac{1}{2\sqrt{k\pi t}} e^{-\frac{(x-y)^2}{4kt}} \quad (3.2.3)$$

for solution of IVP  $u|_{t=0} = g(x)$ .

Recall that  $G(x, y, t)$  quickly decays as  $|x - y| \rightarrow \infty$  and it tends to 0 as  $t \rightarrow 0^+$  for  $x \neq y$ , but  $\int_{-\infty}^{\infty} G(x, y, t) dy = 1$ .

Consider the same equation (3.2.1) on half-line with the homogeneous Dirichlet or Neumann boundary condition at  $x = 0$ :

$$u_D|_{x=0} = 0, \quad (\text{D})$$

$$u_{Nx}|_{x=0} = 0. \quad (\text{N})$$

The method of continuation (see Subsection 2.6.3) works. Indeed, coefficients do not depend on  $x$  and equation contains only even order derivatives with respect to  $x$ . Recall that continuation is even under Neumann condition and odd under Dirichlet condition.

Then we arrive to solutions in a form similar to (3.2.2) but with different function  $G(x, y)$  and domain of integration  $[0, \infty)$ :

$$G = G_D(x, y, t) = G_0(x - y, t) - G_0(x + y, t), \quad (3.2.4)$$

$$G = G_N(x, y, t) = G_0(x - y, t) + G_0(x + y, t) \quad (3.2.5)$$

for (D) and (N) respectively.

Both these functions satisfy equation (3.2.1) with respect to  $(x, t)$ , and corresponding boundary condition

$$G_D|_{x=0} = 0, \quad (3.2.6)$$

$$G_{Nx}|_{x=0} = 0. \quad (3.2.7)$$

Both  $G_D(x, y, t)$  and  $G_N(x, y, t)$  tend to 0 as  $t \rightarrow 0^+$ ,  $x \neq y$  and

$$\int_0^{\infty} G_D(x, y, t) dy \rightarrow 1 \quad \text{as } t \rightarrow 0^+, \quad (3.2.8)$$

$$\int_0^{\infty} G_N(x, y, t) dx = 1. \quad (3.2.9)$$

Further,

$$G(x, y, t) = G(y, x, t) \quad (3.2.10)$$

*Exercise 3.2.1.* (a) Prove (3.2.8) and (3.2.9). Explain the difference.

(b) Prove (3.2.10).

### 3.2.2 Inhomogeneous boundary conditions

Consider now inhomogeneous boundary conditions (one of them)

$$u_D|_{x=0} = p(t), \quad (3.2.11)$$

$$u_{N_x}|_{x=0} = q(t). \quad (3.2.12)$$

Consider

$$0 = \iint_{\Pi} G(x, y, t - \tau) (-u_{\tau}(y, \tau) + ku_{yy}(y, \tau)) d\tau dy$$

with  $\Pi := \Pi_{\epsilon} = \{x > 0, 0 < \tau < t - \epsilon\}$ . Integrating by parts with respect to  $\tau$  in the first term and twice with respect to  $y$  in the second one we get

$$\begin{aligned} 0 &= \iint_{\Pi} \left( -G_t(x, y, t - \tau) + kG_{yy}(x, y, t - \tau) \right) u(y, \tau) d\tau dy \\ &\quad - \int_0^{\infty} G(x, y, \epsilon) u(y, t - \epsilon) dy + \int_0^{\infty} G(x, y, t) u(y, 0) dy \\ &\quad + k \int_0^{t-\epsilon} \left[ -G(x, y, t - \tau) u_y(y, \tau) + G_y(x, y, t - \tau) u(y, \tau) \right]_{y=0} d\tau. \end{aligned}$$

Note that, since  $G(x, y, t)$  satisfies (3.2.1) not only with respect to  $(x, t)$  but also with respect to  $(y, t)$  as well due to symmetry  $G(x, y, t) = G(y, x, t)$ , see (3.2.10), the first line is 0.

In the second line the first term

$$- \int_0^{\infty} G(x, y, \epsilon) u(y, t - \epsilon) dy$$

tends to  $-u(x, t)$  as  $\epsilon \rightarrow 0^+$  because of properties of  $G(x, y, t)$ . Indeed,  $G(x, y, \tau)$  tends everywhere but for  $x = y$  to 0 as  $\tau \rightarrow 0^+$  and its integral from 0 to  $\infty$  tends to 1.

So we get

$$\begin{aligned} u(x, t) &= \int_0^{\infty} G(x, y, t) \underbrace{u(y, 0)}_{=g(y)} dy \\ &\quad + k \int_0^t \left[ -G(x, y, t - \tau) u_y(y, \tau) + G_y(x, y, t - \tau) u(y, \tau) \right]_{y=0} d\tau. \end{aligned} \quad (3.2.13)$$

The first line in the r.h.e. gives us solution of the IBVP with 0 boundary condition. Let us consider the second line.

In the case of Dirichlet boundary condition  $G(x, y, t) = 0$  as  $y = 0$  and therefore we get here

$$k \int_0^t G_y(x, 0, t - \tau) \underbrace{u(0, \tau)}_{=p(\tau)} d\tau.$$

In the case of Neumann boundary condition  $G_y(x, y, t) = 0$  as  $y = 0$  and therefore we get here

$$-k \int_0^t G(x, 0, t - \tau) \underbrace{u(0, \tau)}_{=q(\tau)} d\tau.$$

So, (3.2.13) becomes

$$u_D(x, t) = \int_0^\infty G_D(x, y, t)g(y) dy + k \int_0^t G_{Dy}(x, 0, t - \tau)p(\tau) d\tau \quad (3.2.14)$$

and

$$u_N(x, t) = \int_0^\infty G_N(x, y, t)g(y) dy - k \int_0^t G_N(x, 0, t - \tau)q(\tau) d\tau. \quad (3.2.15)$$

*Remark 3.2.1.* (a) If we consider a half-line  $(-\infty, 0)$  rather than  $(0, \infty)$  then the same terms appear on the right end ( $x = 0$ ) albeit with the opposite sign.

(b) If we consider a finite interval  $(a, b)$  then there will be contributions from both ends.

(c) If we consider Robin boundary condition  $(u_x - \alpha u)|_{x=0} = q(t)$  then formula (3.2.15) would work but  $G$  should satisfy the same Robin condition and we cannot construct  $G$  by the method of continuation.

(d) This proof (which also works for the Cauchy problem) shows that integral formulae give us the unique solution satisfying condition

$$|u(x, t)| \leq C_\epsilon e^{\epsilon|x|^2} \quad \forall t > 0, x, \forall \epsilon > 0$$

provided  $g(x)$  satisfies the same condition. This is much weaker assumption than  $\max |u| < \infty$ .

[Visual examples \(animation\)](#)

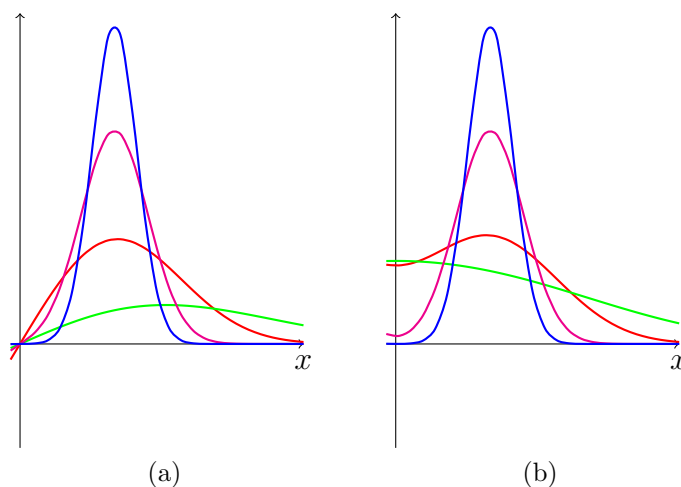

Figure 3.1: Plots of  $G_D(x, y, t)$  and  $G_N(x, y, t)$  as  $y \rightarrow 0$  (for some values of  $t$ )

### 3.2.3 Inhomogeneous Right-hand expression

Consider equation

$$u_t - ku_{xx} = f(x, t). \quad (3.2.16)$$

Either by Duhamel principle applied to the problem (3.2.2)–(3.2.3) or by the method of continuation applied to (3.1.20) we arrive to

**Theorem 3.2.1.** *Solution of (3.2.16), (3.2.3) with homogeneous Dirichlet or Neumann boundary condition at  $x = 0$  is given by*

$$u(x, t) = \int_0^t \int_0^\infty G(x, y, t - \tau) f(y, \tau) dy d\tau + \int_0^\infty G(x, y, t) g(y) dy \quad (3.2.17)$$

with  $G(x, y, t)$  given by (3.2.4) or (3.2.5) correspondingly.

*Remark 3.2.2.* Inhomogeneous boundary conditions could be also incorporated as in (3.2.13).



### 3.2.4 Multidimensional heat equation

Now we claim that for 2D and 3D heat equations

$$u_t = k(u_{xx} + u_{yy}), \quad (3.2.18)$$

$$u_t = k(u_{xx} + u_{yy} + u_{zz}), \quad (3.2.19)$$

similar formulae hold:

$$u = \iint G_2(x, y; x', y'; t)g(x', y') dx' dy', \quad (3.2.20)$$

$$u = \iiint G_3(x, y, z; x', y', z'; t)g(x', y', z') dx' dy' dz' \quad (3.2.21)$$

with

$$G_2(x, y; x', y'; t) = G_1(x, x', t)G_1(y, y', t), \quad (3.2.22)$$

$$G_3(x, y, z; x', y', z'; t) = G_1(x, x', t)G_1(y, y', t)G_1(z, z', t); \quad (3.2.23)$$

in particular for the whole  $\mathbb{R}^n$

$$G_n(\mathbf{x}, \mathbf{x}'; t) = (4\pi kt)^{-\frac{n}{2}} e^{-\frac{|\mathbf{x}-\mathbf{x}'|^2}{4kt}}. \quad (3.2.24)$$

To justify our claim we note that

(a)  $G_n$  satisfies  $n$ -dimensional heat equation. Really, consider f.e.  $G_2$ :

$$\begin{aligned} G_{2t}(x, y; x', y'; t) &= G_{1t}(x, x', t)G_1(y, y', t) + G_1(x, x', t)G_{1t}(y, y', t) \\ &= kG_{1xx}(x, x', t)G_1(y, y', t) + kG_1(x, x', t)G_{1yy}(y, y', t) \\ &= k\Delta(G_{1t}(x, x', t)G_1(y, y', t)) = k\Delta G_2(x, y; x', y'; t). \end{aligned}$$

(b)  $G_n(\mathbf{x}, \mathbf{x}'; t)$  quickly decays as  $|\mathbf{x} - \mathbf{x}'| \rightarrow \infty$  and it tends to 0 as  $t \rightarrow 0^+$  for  $\mathbf{x} \neq \mathbf{x}'$ , but

(c)  $\iint G(\mathbf{x}, \mathbf{x}', t) dy \rightarrow 1$  as  $t \rightarrow 0^+$ .

(d)  $G(\mathbf{x}, \mathbf{x}', t) = G(\mathbf{x}', \mathbf{x}, t)$ .

(e)  $G(\mathbf{x}, \mathbf{x}', t)$  has a rotational (spherical) symmetry with a center at  $\mathbf{x}'$ . No surprise: we considered heat equation in isotropic media.

Properties (b)–(d) are due to the similar properties of  $G_1$  and imply integral representation (3.2.20) (or its  $n$ -dimensional variant).

### Visual examples (animation)

Similarly to Theorem 3.1.5 and following its remark we have now:

**Theorem 3.2.2.** *Let  $u$  satisfy equation (3.2.16) in domain  $\Omega \subset \mathbb{R}_t \times \mathbb{R}_x^n$  with  $f \in C^\infty(\Omega)$ . Then  $u \in C^\infty(\Omega)$ .*

*Remark 3.2.3.* (a) This “product trick” works for heat equation or Schrödinger equation because both of them are equations (not systems)  $u_t = Lu$  with  $L$  which does not contain differentiation by  $t$ .

(b) So far we have not discussed the uniqueness of the solution. In fact, as formulated, the solution is not unique. But do not worry: “extra solutions” are so irregular at infinity that they have no “physical sense”. We discuss it later.

(c) IVP in the direction of negative time is ill-posed. Indeed, if  $f \in C^\infty$  it follows from Theorem 3.2.2 that solution cannot exist for  $t \in (-\epsilon, 0]$  unless  $g \in C^\infty$  (which is only necessary, but not sufficient).

## 3.2.5 Maximum Principle

Consider heat equation in the domain  $\Omega$  like below

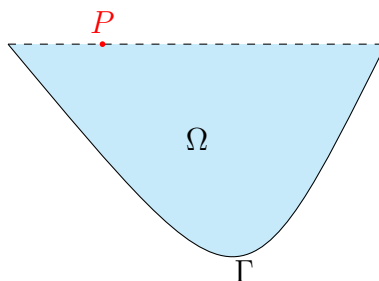

We claim that

**Theorem 3.2.3** (Maximum Principle). *Let  $u$  satisfy heat equation in  $\Omega$ . Then*

$$\max_{\Omega} u = \max_{\Gamma} u. \quad (3.2.25)$$

*Almost correct proof.* Let (3.2.25) be wrong. Then  $\max_{\Omega} u > \max_{\Gamma} u$  and there exists point  $P = (\bar{x}, \bar{t}) \in \Omega \setminus \Gamma$  s.t.  $u$  reaches its maximum at  $P$ . Without any loss of the generality we can assume that  $P$  belongs to an upper lid of  $\Omega$ . Then

$$u_t(P) \geq 0. \quad (3.2.26)$$

Indeed,  $u(\bar{x}, \bar{t}) \geq u(\bar{x}, t)$  for all  $t : \bar{t} > t > \bar{t} - \epsilon$  and then  $(u(\bar{x}, \bar{t}) - u(\bar{x}, t))/(\bar{t} - t) \geq 0$  and as  $t \nearrow \bar{t}$  we get (3.2.26).

Also

$$u_{xx}(P) \leq 0. \quad (3.2.27)$$

Indeed,  $u(x, \bar{t})$  reaches maximum as  $x = \bar{x}$ . This inequality combined with (3.2.26) *almost* contradict to heat equation  $u_t = ku_{xx}$  (“almost” because there could be equalities).  $\square$

*Correct proof.* Note first that the above arguments prove (3.2.25) if  $u$  satisfies inequality  $u_t - ku_{xx} < 0$  because then there will be a contradiction.

Further note that  $v = u - \epsilon t$  satisfies  $v_t - kv_{xx} < 0$  for any  $\epsilon > 0$  and therefore

$$\max_{\Omega} (u - \epsilon t) = \max_{\Gamma} (u - \epsilon t).$$

Taking limit as  $\epsilon \rightarrow 0^+$  we get (3.2.25).  $\square$

*Remark 3.2.4.* (a) Sure, the same proof works for multidimensional heat equation.

(b) In fact, there is a *strict maximum principle*. Namely *either* in  $\Omega \setminus \Gamma$   $u$  is strictly less than  $\max_{\Gamma} u$  *or*  $u = \text{const}$ . The proof is a bit more sophisticated.

**Corollary 3.2.4** (minimum principle).

$$\min_{\Omega} u = \min_{\Gamma} u. \quad (3.2.28)$$

*Proof.* Really,  $-u$  also satisfies heat equation.  $\square$

**Corollary 3.2.5.** (i)  $u = 0$  everywhere on  $\Gamma \implies u = 0$  everywhere on  $\Omega$ .

(ii) Let  $u, v$  both satisfy heat equation. Then  $u = v$  everywhere on  $\Gamma \implies u = v$  everywhere on  $\Omega$ .

*Proof.* (i) Really, then  $\max_{\Omega} u = \min_{\Omega} u = 0$ .

(ii) Really, then  $(u - v)$  satisfies heat equation.  $\square$

## 3.A Project: Walk problem

### 3.1.1 Intro into project: Random walks

Consider a 1D-grid with a step  $h \ll 1$  and also consider grid in time with a step  $\tau \ll 1$ . So,  $x_n = nh$  and  $t_m = m\tau$ .

Assume that probabilities to move to the left and right (to the next point) for one time tick are  $q_L$  and  $q_R$  respectively.

Then denoting by  $p_n^m$  the probability to be at time  $t_m$  at point  $x_n$  we get equation

$$p_n^m = p_{n-1}^{m-1}q_R + p_n^{m-1}(1 - q_L - q_R) + p_{n+1}^{m-1}q_L. \quad (3.A.1)$$

One can rewrite it as

$$\begin{aligned} p_n^m - p_n^{m-1} &= p_{n-1}^{m-1}q_R - 2p_n^{m-1}(q_L + q_R) + p_{n+1}^{m-1}q_L = \\ &= K(p_{n-1}^{m-1} - p_n^{m-1} + p_{n+1}^{m-1}) - L(p_{n+1}^{m-1} - p_{n-1}^{m-1}) \end{aligned} \quad (3.A.2)$$

where we used notations  $K = \frac{1}{2}(q_L + q_R)$  and  $L = \frac{1}{2}(q_R - q_L)$ .

*Task 3.A.1.* Using Taylor formula and assuming that  $p(x, t)$  is a smooth function prove that

$$\Delta p := \frac{1}{h^2}(p_{n+1} - 2p_n + p_{n-1}) = \frac{\partial^2 p}{\partial x^2} + O(h^2), \quad (3.A.3)$$

$$Dp := \frac{1}{2h}(p_{n+1} - p_{n-1}) = \frac{\partial p}{\partial x} + O(h^2), \quad (3.A.4)$$

$$\frac{1}{\tau}(p^m - p_{m-1}) = \frac{\partial p}{\partial t} + O(\tau). \quad (3.A.5)$$

Then (3.A.2) becomes after we neglect small terms

$$\frac{\partial p}{\partial t} = \lambda \frac{\partial^2 p}{\partial x^2} - \mu \frac{\partial p}{\partial x} \quad (3.A.6)$$

where  $K = \lambda\tau/h^2$ ,  $L = \mu\tau/2h$ .

*Remark 3.A.1.* This is a correct scaling or we will not get any PDE.

*Remark 3.A.2.* Here  $p = p(x, t)$  is not a probability but a *probability density*: probability to be at moment  $t$  on interval  $(x, x + dx)$  is  $\mathbb{P}(x < \xi(t) < x + dx) = p(x, t) dx$ . Since  $\sum_{-\infty < n < \text{infy}} p_n^m = 1$  we have

$$\int_{-\infty}^{\infty} p(x, t) dx = 1. \quad (3.A.7)$$

*Remark 3.A.3.* The first term on the right of (3.A.6) is a *diffusion term*; in the case of symmetric walk  $q_L = q_R$  only it is present:

$$\frac{\partial p}{\partial t} = \lambda \frac{\partial^2 p}{\partial x^2}. \quad (3.A.8)$$

The second term on the right of (3.A.6) is a *convection term*; moving it to the left and making change of coordinates  $t_{\text{new}} = t$ ,  $x_{\text{new}} = x - \mu t$  we get in this new coordinates equation (3.A.8). So this term is responsible for the shift with a constant speed  $\mu$  (on the top of diffusion).

*Remark 3.A.4.* (3.A.2) is a *finite difference equation* which is a *finite difference approximation* for PDE (3.A.7). However this approximation is *stable* only if  $\tau \leq \frac{h^2}{2\lambda}$ . This is a fact from *numerical analysis*.

*Task 3.A.2 (Main task).* Multidimensional case. Solution (in due time when we study). BVP. More generalization (later).

### 3.1.2 Absorption problem

Consider 1D-walk (with the same rules) on a segment  $[0, l]$  with both *absorbing* ends. Let  $p_n$  be a probability that our walk will end up at  $l$  if started from  $x_n$ . Then

$$p_n = p_{n-1}q_L + p_{n+1}q_R + p_n(1 - q_L - q_R). \quad (3.A.9)$$

*Task 3.A.3.* Prove limiting equation

$$0 = \lambda \frac{\partial^2 p}{\partial x^2} - \mu \frac{\partial p}{\partial x}. \quad (3.A.10)$$

Solve it under boundary conditions  $p(0) = 0$ ,  $p(l) = 1$ . Explain these boundary conditions.

*Remark 3.A.5.* Here  $p = p(x)$  is a probability and (3.A.7) does not hold.

*Task 3.A.4* (Main task). Multidimensional case: in the domain with the boundary. Boundary conditions (there is a part  $\Gamma$  of the boundary and we are interested in the probability to end up here if started from given point). May be: Generalization: part of boundary is reflecting.

## 3.B Self-similar solutions

Like [running-wave solutions](../Chapter2/S2.3.A.html) self-similar solutions is an another class of interesting solutions. For linear equations these solutions can lead to the general solutions. For non-linear equations it is not the case.

*Example 3.B.1.* Self-similar solution to heat equation

$$u_t = u_{xx} \quad (3.B.1)$$

We plug  $u_\lambda(x, t) = \lambda^\beta u(\lambda x, \lambda^\alpha t)$  into the same equation and find that it satisfies the same equation as  $\alpha = 2$ . Here  $\beta$  can be any and in Section 3.1 we got  $\beta = 1$  only due to additional conditions  $u(x, t) \geq 0$  and

$$\int_{-\infty}^{\infty} u(x, t) dx < \infty. \quad (3.B.2)$$

Then we plug  $\lambda = t^{-\frac{1}{2}}$  and get

$$u(x, t) = t^{-\frac{1}{2}} u(xt^{-\frac{1}{2}}, 1) = t^{-\frac{1}{2}} \phi(xt^{-\frac{1}{2}}) \quad (3.B.3)$$

and this expression we plugged into (3.B.1) to get ODE for  $\phi$  and solve it.

*Example 3.B.2.* Self-similar solution to linearized Korteweg–De Vries equation

$$u_t = u_{xxx}. \quad (3.B.4)$$

We do the same thing albeit now  $\alpha = 3$  and to get  $\beta = 1$  we need to appeal to (3.B.2) or something similar. Then

$$-\frac{1}{3}(\xi\phi)' = \phi''' \implies -\frac{1}{3}\xi\phi = \phi''$$

where again we neglect a constant. This is an Airy equation (which appears in the theory of diffraction) and its solutions are [Airy functions](#).

*Example 3.B.3.* Let us try

$$u_t = u_x + u_{xxx}.$$

There are 3 terms and they scale differently and we cannot select  $\alpha$  (in the linear equations  $\beta$  is arbitrary).

*Example 3.B.4.* Self-similar solution to viscous Burgers equation

$$u_t + uu_x = u_{xx}. \quad (3.B.5)$$

Again three terms scale differently but now non-linearity helps:

$$\begin{aligned} u_{\lambda t}(x, t) &= \lambda^\beta u(\lambda x, \lambda^\alpha t), \\ u_{\lambda xx}(x, t) &= \lambda^{\beta+2\alpha} u(\lambda x, \lambda^\alpha t), \\ u_\lambda u_{\lambda x} &= \lambda^{2\beta+1} (uu_x)(\lambda x, \lambda^\alpha t) \end{aligned}$$

and we need to have all three powers equal, which leads to  $\alpha = 2$  and  $\beta = 1$  without reference to (3.B.2). It leads to (3.B.3) and plugging into (3.B.5) we get

$$-\frac{1}{2}(\xi\phi)' + \phi\phi' = \phi''. \quad (3.B.6)$$

Integrating we get

$$-\frac{1}{2}\xi\phi + \frac{1}{2}\phi^2 = \phi' \quad (3.B.7)$$

where we took a constant 0 because we still want solutions to decay at infinity.

This is Bernoulli's equation. Rewriting it as

$$\begin{aligned} (\phi e^{\xi^2/4})' &= \frac{1}{2}\phi^2 e^{\xi^2/4} \implies (\phi e^{\xi^2/4})^{-2} (\phi e^{\xi^2/4})' = e^{-\xi^2/4} \implies \\ &(\phi e^{\xi^2/4})^{-1} = \sqrt{\pi} \left( \operatorname{erf}(\xi/2) + D \right) \implies \end{aligned}$$

and finally

$$\phi(\xi) = \frac{e^{-\xi^2/4}}{\sqrt{\pi} \left( \operatorname{erf}(\xi/2) + D \right)}$$

with  $|D| > 1$  to prevent vanishing determinant. And we get expression for  $u(x, t)$ .

*Example 3.B.5.* Self-similar solution to Korteweg–De Vries equation

$$u_t + uu_x = u_{xxx}. \quad (3.B.8)$$

Repeating arguments of Example 3.B.4 we arrive to

$$u(x, t) = t^{-\frac{1}{3}}\phi(xt^{-\frac{1}{3}}). \quad (3.B.9)$$

Then

$$-\frac{1}{3}(\xi\phi)' + \phi'\phi = \phi''' \implies -\frac{1}{3}\xi\phi + \frac{1}{2}\phi^2 = \phi''$$

where we again neglect a constant. This is a non-linear second order equation and we cannot solve it explicitly (but can investigate its properties).

### 3.C Schrödinger equation

Consider Schrödinger equation

$$u_t = iu_{xx} \quad -\infty < t < \infty \quad (3.C.1)$$

which we get from diffusion equation formally setting  $k = i$ . We can apply the same arguments arriving to

$$u(x, t) = \frac{1}{\sqrt{4\pi it}} e^{ix^2/4t} \quad (3.C.2)$$

but we need to figure out the "sign" of the square root. Also we need to extend  $t > 0$  for diffusion equation for all  $t$  for Schrödinger equation.

Consider  $k \in \mathbb{C}$ :  $\text{Re}(k) > 0$ . Then the diffusion equation still has sense for  $t > 0$  and the square root is uniquely determined so for  $k = i = e^{i\pi/2}$  we get instead a correct value of  $\sqrt{4\pi it}$ , namely,  $e^{i\pi/4}\sqrt{4\pi t}$ .

Now, as  $t < 0$  we should consider  $t > 0$  and take a complex-conjugate, thus arriving to

$$u(x, t) = \frac{e^{\mp\frac{\pi i}{4}}}{\sqrt{4\pi|t|}} e^{ix^2/4t} \quad \text{as } \pm t > 0 \quad (3.C.3)$$

as a solution to Schrödinger equation (3.C.1) with initial condition

$$u|_{t=0} = \delta(x). \quad (3.C.4)$$



### Problems to Chapter 3

Crucial in many problems is formula (3.2.14) rewritten as

$$u(x, t) = \int_{-\infty}^{\infty} G(x, y, t)g(y) dy. \quad (1)$$

with

$$G(x, y, t) = \frac{1}{2\sqrt{k\pi t}} e^{-\frac{(x-y)^2}{4kt}} \quad (2)$$

This formula solves IVP for a heat equation

$$u_t = ku_{xx} \quad (3)$$

with the initial function  $g(x)$ .

In many problems below for a modified standard problem you need to derive a similar formula albeit with modified  $G(x, y, t)$ . Consider

$$\operatorname{erf}(z) = \frac{2}{\sqrt{\pi}} \int_0^z e^{-z^2} dz \quad (\operatorname{Erf})$$

as a standard function.

*Problem 1.* Solve Cauchy problem for a heat equation

$$\begin{cases} u_t = ku_{xx} & t > 0, \quad -\infty < x < \infty \\ u|_{t=0} = g(x) \end{cases} \quad (4)$$

with

$$\begin{aligned} g(x) &= \begin{cases} 1 & |x| < 1, \\ 0 & |x| \geq 1; \end{cases} & g(x) &= \begin{cases} 1 - |x| & |x| < 1, \\ 0 & |x| \geq 1; \end{cases} \\ g(x) &= e^{-a|x|}; & g(x) &= xe^{-a|x|}; \\ g(x) &= |x|e^{-a|x|}; & g(x) &= x^2e^{-a|x|}; \end{aligned}$$

$$\begin{aligned} g(x) &= e^{-ax^2}; & g(x) &= xe^{-ax^2}; \\ g(x) &= x^2e^{-ax^2}. \end{aligned}$$

*Problem 2.* Using method of continuation obtain formula similar to (1)-(2) for solution of IBVP for a heat equation on  $x > 0, t > 0$  with the initial function  $g(x)$  and with

- (a) Dirichlet boundary condition  $u|_{x=0} = 0$ ;
- (b) Neumann boundary condition  $u_x|_{x=0} = 0$ ;

*Problem 3.* Solve IBVP problem for a heat equation

$$\begin{cases} u_t = ku_{xx} & t > 0, 0 < x < \infty \\ u|_{t=0} = g(x) \\ u|_{x=0} = h(t) \end{cases} \quad (5)$$

with

$$\begin{aligned} g(x) = 0, \quad h(t) &= \begin{cases} 1 & t < 1, \\ 0 & t \geq 1; \end{cases} & g(x) &= \begin{cases} 1 & x < 1, \\ 0 & x \geq 1, \end{cases} \quad h(t) = 0; \\ g(x) &= \begin{cases} 1-x & x < 1, \\ 0 & x \geq 1, \end{cases} \quad h(t) = 0; & g(x) &= \begin{cases} 1-x^2 & x < 1, \\ 0 & x \geq 1, \end{cases} \quad h(t) = 0; \\ g(x) &= e^{-ax}, \quad h(t) = 0; & g(x) &= xe^{-ax}, \quad h(t) = 0; \\ g(x) &= e^{-ax^2}, \quad h(t) = 0; & g(x) &= xe^{-ax^2}, \quad h(t) = 0; \\ g(x) &= x^2e^{-ax^2}, \quad h(t) = 0; & g(x) &= 0, \quad h(t) = 1; \\ g(x) &= 1, \quad h(t) = 0; \end{aligned}$$

*Problem 4.*

$$\begin{cases} u_t = ku_{xx} & t > 0, 0 < x < \infty \\ u|_{t=0} = g(x) \\ u_x|_{x=0} = h(t) \end{cases} \quad (6)$$

with

$$g(x) = 0, \quad h(t) = \begin{cases} 1 & t < 1, \\ 0 & t \geq 1; \end{cases} \quad g(x) = \begin{cases} 1 & x < 1, \\ 0 & x \geq 1, \end{cases} \quad h(t) = 0;$$

$$g(x) = \begin{cases} 1-x & x < 1, \\ 0 & x \geq 1, \end{cases} \quad h(t) = 0; \quad g(x) = e^{-ax}, \quad h(t) = 0;$$

$$g(x) = xe^{-ax}, \quad h(t) = 0; \quad g(x) = e^{-ax^2}, \quad h(t) = 0;$$

$$g(x) = xe^{-ax^2}, \quad h(t) = 0; \quad g(x) = x^2e^{-ax^2}, \quad h(t) = 0;$$

$$g(x) = 0, \quad h(t) = 1; \quad g(x) = 1, \quad h(t) = 0;$$

*Problem 5.* Using method of continuation obtain formula similar to (1)-(2) for solution of IBVP for a heat equation on  $\{x > 0, t > 0\}$  with the initial function  $g(x)$  and with

- Dirichlet boundary condition on both ends  $u|_{x=0} = u|_{x=L} = 0$ ;
- Neumann boundary condition on both ends  $u_x|_{x=0} = u_x|_{x=L} = 0$ ;
- Dirichlet boundary condition on one end and Neumann boundary condition on another  $u|_{x=0} = u_x|_{x=L} = 0$ .

*Problem 6.* Consider heat equation with a convection term

$$u_t + \underbrace{cu_x}_{\text{convection term}} = ku_{xx}. \quad (7)$$

- Prove that it is obtained from the ordinary heat equation with respect to  $U$  by a change of variables  $U(x, t) = u(x + ct, t)$ . Interpret (7) as equation describing heat propagation in the media moving to the right with the speed  $c$ .
- Using change of variables  $u(x, t) = U(x - vt, t)$  reduce it to ordinary heat equation and using (1)-(2) for a latter write a formula for solution  $u(x, t)$ .
- Can we use the method of continuation *directly* to solve IBVP with Dirichlet or Neumann boundary condition at  $x > 0$  for (7) on  $\{x > 0, t > 0\}$ ? Justify your answer.

- (d) Plugging  $u(x, t) = v(x, t)e^{\alpha x + \beta t}$  with appropriate constants  $\alpha, \beta$  reduce (7) to ordinary heat equation.
- (e) Using (d) write formula for solution of such equation on the half-line or an interval in the case of Dirichlet boundary condition(s). Can we use this method in the case of Neumann boundary conditions? Justify your answer.

*Problem 7.* Using either formula (1)-(2) or its modification (if needed)

- (a) Solve IVP for a heat equation (3) with  $g(x) = e^{-\varepsilon|x|}$ ; what happens as  $\varepsilon \rightarrow +0$ ?
- (b) Solve IVP for a heat equation with convection (7) with  $g(x) = e^{-\varepsilon|x|}$ ; what happens as  $\varepsilon \rightarrow +0$ ?
- (c) Solve IBVP with the Dirichlet boundary condition for a heat equation (7) with  $g(x) = e^{-\varepsilon|x|}$ ; what happens as  $\varepsilon \rightarrow +0$ ?
- (d) Solve IBVP with the Neumann boundary condition for a heat equation (3) with  $g(x) = e^{-\varepsilon|x|}$ ; what happens as  $\varepsilon \rightarrow +0$ ?

*Problem 8.* Consider a solution of the diffusion equation  $u_t = u_{xx}$  in  $[0 \leq x \leq L, 0 \leq t < \infty]$ .

Let

$$M(T) = \max_{[0 \leq x \leq L, 0 \leq t \leq T]} u(x, t),$$

$$m(T) = \min_{[0 \leq x \leq L, 0 \leq t \leq T]} u(x, t).$$

- (a) Does  $M(T)$  increase or decrease as a function of  $T$ ?
- (b) Does  $m(T)$  increase or decrease as a function of  $T$ ?

*Problem 9.* The purpose of this exercise is to show that the maximum principle is not true for the equation  $u_t = xu_{xx}$  which has a coefficient which changes sign.

- (a) Verify that  $u = -2xt - x^2$  is a solution.
- (b) Find the location of its maximum in the closed rectangle  $[-2 \leq x \leq 2, 0 \leq t \leq 1]$ .

- (c) Where precisely does our proof of the maximum principle break down for this equation?

*Problem 10.* (a) Consider the heat equation on  $J = (-\infty, \infty)$  and prove that an “energy”

$$E(t) = \int_J u^2(x, t) dx \quad (8)$$

does not increase; further, show that it really decreases unless  $u(x, t) = \text{const}$ ;

- (b) Consider the heat equation on  $J = (0, l)$  with the Dirichlet or Neumann boundary conditions and prove that an  $E(t)$  does not increase; further, show that it really decreases unless  $u(x, t) = \text{const}$ ;
- (c) Consider the heat equation on  $J = (0, l)$  with the Robin boundary conditions

$$u_x(0, t) - a_0 u(0, t) = 0, \quad (9)$$

$$u_x(L, t) + a_L u(L, t) = 0. \quad (10)$$

If  $a_0 > 0$  and  $a_l > 0$ , show that the endpoints contribute to the decrease of  $E(t) = \int_0^L u^2(x, t) dx$ .

This is interpreted to mean that part of the *energy* is lost at the boundary, so we call the boundary conditions *radiating* or *dissipative*.

*Hint.* To prove decrease of  $E(t)$  consider its derivative by  $t$ , replace  $u_t$  by  $ku_{xx}$  and integrate by parts.

*Remark 3.P.1* In the case of heat (or diffusion) equation an *energy* given by (8) is rather mathematical artefact.

*Problem 11.* Find a self-similar solution  $u$  of

$$u_t = (u^m u_x)_x \quad -\infty < x < \infty, t > 0$$

with finite  $\int_{-\infty}^{\infty} u dx$ .

*Problem 12.* Find a self-similar solution  $u$  of

$$u_t = iku_{xx} \quad -\infty < x < \infty, t > 0$$

with constant  $\int_{-\infty}^{\infty} u dx = 1$ .

*Hint.* Some complex variables required.

*Problem 13.* Find smooth for  $t > 0$  self-similar solution  $u(x, t)$  to

$$\begin{aligned} u_t &= (xu_x)_x & x > 0, \quad t > 0, \\ u|_{x=0} &= t^{-1} & t > 0. \end{aligned}$$

*Problem 14.* Find smooth for  $t > 0$  self-similar solution  $u(x, t)$  to

$$\begin{aligned} u_t + uu_x &= 0 & -\infty < x < \infty, \quad t > 0, \\ u|_{t=0} &= \text{sign}(x) := \frac{x}{|x|}. \end{aligned}$$

*Problem 15.* Find smooth for  $t > 0$  self-similar solution  $u(x, t)$  to

$$\begin{aligned} u_t + (uu_x)_x &= 0 & -\infty < x < \infty, \quad t > 0, \\ u &\geq 0, & \int_{-\infty}^{\infty} u(x, t) dx < \infty. \end{aligned}$$

*Problem 16.* Find smooth for  $t > 0$  self-similar solution  $u(x, t)$  to

$$\begin{aligned} u_t + u_{xx} &= 0 & -\infty < x < \infty, \quad t > 0, \\ u|_{t=0} &= \text{sign}(x) := \frac{x}{|x|}. \end{aligned}$$

You are not allowed to use a standard formula for solution of IVP for heat equation.

*Problem 17.* Consider 1D “radioactive cloud” problem:

$$\begin{aligned} u_t + vu_x - u_{xx} + \beta u &= 0, \\ u|_{t=0} &= \delta(x), \end{aligned}$$

where  $v$  is a wind velocity,  $\beta$  shows the speed of “dropping on the ground”.

(a) *Hint.* Reduce to the standard heat equation by  $u = ve^{-\beta t}$  and  $x = y + vt$ , use the standard formula for  $v$ :

$$v = (4\pi t)^{-1/2} \exp(-x^2/4t)$$

and then write down  $u(x, t)$ .

(b) Find “contamination level” at  $x$

$$D(x) = \beta \int_0^{\infty} u(x, t) dt.$$

*Hint.* By change of variables  $t = y^2$  with appropriate  $z$  reduce to calculation of

$$\int \exp(-ay^2 - by^{-2}) dy$$

and calculate it using f.e. <https://www.wolframalpha.com> with input

`int_0^infy exp (-ay^2-b/y^2)dy`

you may need to do it few times)

(c) Try to generalize to 2-dimensional case:

$$\begin{aligned} u_t + vu_x - (u_{xx} + u_{yy}) + \beta u &= 0, \\ u|_{t=0} &= \delta(x)\delta(y). \end{aligned}$$

# Chapter 4

## Separation of Variables and Fourier Series

In this Chapter we consider simplest separation of variables problems, arising simplest eigenvalue problems and corresponding Fourier series.

### 4.1 Separation of variables (the first blood)

Consider IBVP for homogeneous 1D-wave equation on the *finite interval*  $(0, l)$ :

$$u_{tt} - c^2 u_{xx} = 0, \quad 0 < x < l, \quad (4.1.1)$$

$$u|_{x=0} = u|_{x=l} = 0, \quad (4.1.2)$$

$$u|_{t=0} = g(x), \quad u_t|_{t=0} = h(x). \quad (4.1.3)$$

Note, that the boundary conditions are also homogeneous. So inhomogeneous are only initial conditions.

#### 4.1.1 Separation of variables

Let us skip temporarily initial conditions (4.1.3) and consider only (4.1.1)–(4.1.2). and look for a solution in a special form

$$u(x, t) = X(x)T(t) \quad (4.1.4)$$

with unknown functions  $X(x)$  on  $(0, l)$  and  $T(t)$  on  $(-\infty, \infty)$ .



*Remark 4.1.1.* We are looking for *non-trivial solution*  $u(x, t)$  which means that  $u(x, t)$  is not identically 0. Therefore neither  $X(x)$  nor  $T(t)$  could be identically 0 either.

Plugging (4.1.4) (which is  $(u(x, t) = X(x)T(t))$ ) into (4.1.1)–(4.1.2) we get

$$X(x)T''(t) = c^2X''(x)T(t),$$

$$X(0)T(t) = X(l)T(t) = 0,$$

which after division by  $X(x)T(t)$  and  $T(t)$  respectively become

$$\frac{T''(t)}{T(t)} = c^2\frac{X''(x)}{X(x)}, \quad (4.1.5)$$

$$X(0) = X(l) = 0. \quad (4.1.6)$$

Recall, neither  $X(x)$  nor  $T(t)$  are identically 0.

In equation (4.1.5) the l.h.e. does not depend on  $x$  and the r.h.e. does not depend on  $t$  and since we have an identity we conclude that

Both expressions do not depend on  $x, t$  and therefore *they are constant*.

This is a *crucial conclusion of the separation of variables method*. We rewrite the (4.1.5) as two equalities

$$\frac{T''(t)}{T(t)} = -c^2\lambda, \quad \frac{X''(x)}{X(x)} = -\lambda,$$

with *unknown constant*  $\lambda$ , which in turn we rewrite as (4.1.7) and (4.1.8):

$$X'' + \lambda X = 0, \quad (4.1.7)$$

$$X(0) = X(l) = 0, \quad (4.1.6)$$

$$T'' + c^2\lambda T = 0. \quad (4.1.8)$$

## 4.1.2 Eigenvalue problem

Consider BVP (for ODE) (4.1.7)–(4.1.6): It is usually called *Sturm-Liouville problem*. We need to find its solution  $X(x)$  which is not identically 0.

**Definition 4.1.1.** Such solutions are called *eigenfunctions* and corresponding numbers  $\lambda$  *eigenvalues* (compare with *eigenvectors* and *eigenvalues*).

**Proposition 4.1.1.** *Problem (4.1.7)–(4.1.6) has eigenvalues and eigenfunctions*

$$\lambda_n = \frac{\pi^2 n^2}{l^2} \quad n = 1, 2, \dots, \quad (4.1.9)$$

$$X_n(x) = \sin\left(\frac{\pi n x}{l}\right). \quad (4.1.10)$$

*Proof.* Note that (4.1.7) is a 2-nd order linear ODE with constant coefficients and to solve it one needs to consider *characteristic equation*

$$k^2 + \lambda = 0 \quad (4.1.11)$$

and therefore  $k_{1,2} = \pm\sqrt{-\lambda}$  and  $X(x) = Ae^{\sqrt{-\lambda}x} + Be^{-\sqrt{-\lambda}x}$  (provided  $\lambda \neq 0$ ). So far  $\lambda \in \mathbb{C}$ .

Plugging into  $X(0) = 0$  and  $X(l) = 0$  we get

$$\begin{aligned} A + B &= 0, \\ Ae^{\sqrt{-\lambda}l} + Be^{-\sqrt{-\lambda}l} &= 0 \end{aligned}$$

and this system has a non-trivial solution  $(A, B) \neq 0$  if and only if its determinant is 0:

$$\begin{aligned} \begin{vmatrix} 1 & 1 \\ e^{\sqrt{-\lambda}l} & e^{-\sqrt{-\lambda}l} \end{vmatrix} &= e^{-\sqrt{-\lambda}l} - e^{\sqrt{-\lambda}l} = 0 \iff e^{2\sqrt{-\lambda}l} = 1 \\ &\iff 2\sqrt{-\lambda}l = 2\pi ni \quad \text{with } n=1,2,\dots \end{aligned}$$

Here we excluded  $n = 0$  since  $\lambda \neq 0$ , and also  $n = -1, -2, \dots$  since both  $n$  and  $-n$  lead to the same  $\lambda$  and  $X$ . The last equation is equivalent to (4.1.9):  $\lambda_n = \frac{\pi^2 n^2}{l^2}$ . Then  $k_{1,2} = \pm\frac{\pi ni}{l}$ .

Meanwhile  $B = -A$  anyway and we get  $X = 2Ai \sin\left(\frac{\pi nx}{l}\right)$  i.e.

$$X_n(x) = \sin\left(\frac{\pi nx}{l}\right) \quad (10)$$

since *the constant factor does not matter*.

So far we have not covered  $\lambda = 0$ . But then  $k_{1,2} = 0$  and  $X = A + Bx$  and plugging into (4.1.6) we get  $A = A + Bl = 0 \implies A = B = 0$  and  $\lambda = 0$  is not an eigenvalue.  $\square$

### 4.1.3 Simple solutions

After eigenvalue problem has been solved we plug  $\lambda = \lambda_n$  into (4.1.8) (which is  $T'' + c^2\lambda T = 0$ ):

$$T'' + \left(\frac{c\pi n}{l}\right)^2 T = 0 \quad (4.1.12)$$

which is also a 2-nd order linear ODE with constant coefficients.

Characteristic equation  $k^2 + \left(\frac{c\pi n}{l}\right)^2 = 0$  has solutions  $k_{1,2} = \pm \frac{c\pi ni}{l}$  and therefore

$$T_n(t) = A_n \cos\left(\frac{c\pi nt}{l}\right) + B_n \sin\left(\frac{c\pi nt}{l}\right) \quad (4.1.13)$$

and finally we get a *simple solution*

$$u_n(x, t) = \underbrace{\left(A_n \cos\left(\frac{c\pi nt}{l}\right) + B_n \sin\left(\frac{c\pi nt}{l}\right)\right)}_{=T_n(t)} \cdot \underbrace{\sin\left(\frac{\pi nx}{l}\right)}_{=X_n(x)} \quad \text{with } n = 1, 2, \dots \quad (4.1.14)$$

This *simple solution* (4.1.14) can be rewritten as

$$u_n(x, t) = C_n \cos\left(\frac{c\pi nt}{l} + \phi_n\right) \sin\left(\frac{\pi nx}{l}\right)$$

represents a *standing wave*:

#### Standing Wave

which one can decompose into a sum of running waves

#### Standing Wave Decomposition

and the general discussion of standing waves could be found in [Standing Wave Discussion](#).

Points which do not move are called *nodes* and points with maximal amplitude are called *antinodes*.

### 4.1.4 General solutions

The sum of solutions of (4.1.1)-(4.1.2) is also a solution:

$$u(x, t) = \sum_{n=1}^{\infty} \left( A_n \cos\left(\frac{c\pi n t}{l}\right) + B_n \sin\left(\frac{c\pi n t}{l}\right) \right) \cdot \sin\left(\frac{\pi n x}{l}\right). \quad (4.1.15)$$

We have an important question to answer:

*Have we covered all solutions of (4.1.1)-(4.1.2)? – Yes, we did, but we need to justify it.*

Plugging (4.1.15) into initial conditions (4.1.3)<sub>1,2</sub> (that is  $u|_{t=0} = g(x)$  and  $u_t|_{t=0} = h(x)$ ) we get respectively

$$\sum_{n=1}^{\infty} A_n \sin\left(\frac{\pi n x}{l}\right) = g(x), \quad (4.1.16)$$

$$\sum_{n=1}^{\infty} \frac{c\pi n}{l} B_n \sin\left(\frac{\pi n x}{l}\right) = h(x). \quad (4.1.17)$$

*How to find  $A_n$  and  $B_n$ ? Do they exist? Are they unique?*

What we got are *Fourier series* (actually sin-Fourier series). And we consider their theory in the several next sections (and many lectures).

[Visual Examples \(Animation\)](#).

More coming! Including multidimensional:

[Visual Examples \(Animation: Disk\)](#).

## 4.2 Eigenvalue problems

### 4.2.1 Problems with explicit solutions

*Example 4.2.1* (Dirichlet-Dirichlet). Consider eigenvalue problem from Section 4.1:

$$X'' + \lambda X = 0 \quad 0 < x < l, \quad (4.2.1)$$

$$X(0) = X(l) = 0; \quad (4.2.2)$$

it has eigenvalues and corresponding eigenfunctions

$$\lambda_n = \left(\frac{\pi n}{l}\right)^2, \quad n = 1, 2, \dots \quad (4.2.3)$$

$$X_n = \sin\left(\frac{\pi n}{l}x\right). \quad (4.2.4)$$

[Visual Examples \(animation\)](#)

*Example 4.2.2* (Neumann-Neumann). Consider eigenvalue problem

$$X'' + \lambda X = 0 \quad 0 < x < l, \quad (4.2.5)$$

$$X'(0) = X'(l) = 0 \quad (4.2.6)$$

it has eigenvalues and corresponding eigenfunctions

$$\lambda_n = \left(\frac{\pi n}{l}\right)^2, \quad n = 0, 1, 2, \dots \quad (4.2.7)$$

$$X_n = \cos\left(\frac{\pi n}{l}x\right). \quad (4.2.8)$$

[Visual Examples \(animation\)](#)

Indeed, plugging  $X = Ae^{kx} + Be^{-kx}$ ,  $k = \sqrt{-\lambda} \neq 0$  into (4.2.6)  $X'(0) = X'(l) = 0$  we get

$$\begin{aligned} A - B &= 0, \\ Ae^{\sqrt{-\lambda}l} - Be^{-\sqrt{-\lambda}l} &= 0 \end{aligned}$$

where we divided the last equation by  $\sqrt{-\lambda}$ , which leads to the same condition  $2\sqrt{-\lambda}l = 2\pi in$ ,  $n = 1, 2, \dots$  as before but with eigenfunctions (4.2.8):  $\cos\left(\frac{\pi n}{l}x\right)$  rather than  $\sin\left(\frac{\pi n}{l}x\right)$  as in Example 4.2.1.

But now, plugging  $\lambda = 0$  and  $X = A + Bx$  we get  $B = 0$  and  $X(x) = 1$  is also an eigenfunction and we should add  $n = 0$ .

*Example 4.2.3* (Dirichlet-Neumann). Consider eigenvalue problem

$$X'' + \lambda X = 0 \quad 0 < x < l, \quad (4.2.9)$$

$$X(0) = X'(l) = 0 \quad (4.2.10)$$

has eigenvalues and corresponding eigenfunctions

$$\lambda_n = \left(\frac{\pi(2n+1)}{2l}\right)^2, \quad n = 0, 1, 2, \dots \quad (4.2.11)$$

$$X_n = \sin\left(\frac{\pi(2n+1)}{2l}x\right) \quad (4.2.12)$$

[Visual Examples \(animation\)](#)

Indeed, plugging  $X = Ae^{kx} + Be^{-kx}$ ,  $k = \sqrt{-\lambda} \neq 0$  into (4.2.6)  $X'(0) = X'(l) = 0$  we get

$$\begin{aligned} A + B &= 0, \\ Ae^{\sqrt{-\lambda}l} - Be^{-\sqrt{-\lambda}l} &= 0 \end{aligned}$$

where we divided the last equation by  $\sqrt{-\lambda}$ , which leads to condition  $2\sqrt{-\lambda}l = (2\pi n + 1)i$ ,  $n = 0, 1, 2, \dots$  and with eigenfunctions (4.2.12):  $X_n = \sin\left(\frac{\pi(2n+1)}{2l}x\right)$ .

Plugging  $\lambda = 0$  and  $X = A + Bx$  we get  $B = 0$  and  $A = 0$ , so  $\lambda = 0$  is not an eigenvalue. The same problem albeit with the ends reversed (i.e.  $X'(0) = X(l) = 0$ ) has the same eigenvalues and eigenfunctions  $\cos\left(\frac{\pi(2n+1)}{2l}x\right)$ .

*Example 4.2.4* (periodic). Consider eigenvalue problem

$$X'' + \lambda X = 0 \quad 0 < x < l, \quad (4.2.13)$$

$$X(0) = X(l), \quad X'(0) = X'(l); \quad (4.2.14)$$

it has eigenvalues and corresponding eigenfunctions

$$\lambda_0 = 0, \quad (4.2.15)$$

$$X_0 = 1, \quad (4.2.16)$$

$$\lambda_{2n-1} = \lambda_{2n} = \left(\frac{2\pi n}{l}\right)^2, \quad n = 1, 2, \dots \quad (4.2.17)$$

$$X_{2n-1} = \cos\left(\frac{2\pi n}{l}x\right), \quad X_{2n} = \sin\left(\frac{2\pi n}{l}x\right). \quad (4.2.18)$$

[Visual Examples \(animation\)](#)

Alternatively, as all eigenvalues but 0 have multiplicity 2 one can select

$$\lambda_n = \left(\frac{2\pi n}{l}\right)^2, \quad n = \dots, -2, -1, 0, 1, 2, \dots \quad (4.2.19)$$

$$X_n = \exp\left(\frac{2\pi n}{l}ix\right). \quad (4.2.20)$$

Indeed, now we get

$$\begin{aligned} A(1 - e^{\sqrt{-\lambda}l}) + B(1 - e^{-\sqrt{-\lambda}l}) &= 0, \\ A(1 - e^{\sqrt{-\lambda}l}) - B(1 - e^{-\sqrt{-\lambda}l}) &= 0 \end{aligned}$$

which means that  $e^{\sqrt{-\lambda}l} = 1 \iff \sqrt{-\lambda} = 2\pi ni$  and in this case we get two linearly independent eigenfunctions.

As  $\lambda = 0$  we get just one eigenfunction  $X_0 = 1$ .

*Example 4.2.5* (quasiperiodic). Consider eigenvalue problem

$$X'' + \lambda X = 0 \quad 0 < x < l, \quad (4.2.21)$$

$$X(0) = e^{-ikl}X(l), \quad X'(0) = X'(l)e^{-ikl} \quad (4.2.22)$$

with  $0 < k < \frac{2\pi}{l}$ ; it has eigenvalues and corresponding eigenfunctions

$$\lambda_n = \left(\frac{2\pi n}{l} + k\right)^2, \quad n = 0, 2, 4, \dots \quad (4.2.23)$$

$$X_n = \exp\left(\left[\frac{2\pi n}{l} + k\right]ix\right), \quad (4.2.24)$$

$$\lambda_n = \left(\frac{2\pi(n+1)}{l} - k\right)^2, \quad n = 1, 3, 5, \dots \quad (4.2.25)$$

$$X_n = \exp\left(\left[\frac{2\pi(n+1)}{l} - k\right]ix\right). \quad (4.2.26)$$

$k$  is called *quasimomentum*.

(a) For  $k = 0, \frac{2\pi}{l}$  we get periodic solutions, considered in the previous Example 4.2.4,

(b) for  $k = \frac{\pi}{l}$  we get *antiperiodic solutions*

### Visual Examples (animation)

where all eigenvalues have multiplicity 2 (both  $l$ -periodic and  $l$ -antiperiodic functions are  $2l$ -periodic, and each  $2l$ -periodic is the sum of  $l$ -periodic and  $l$ -antiperiodic functions).

(c) For all other  $k$  eigenvalues are real and simple but eigenfunctions are not real-valued.

Indeed, we get now

$$\begin{aligned} A(e^{ikl} - e^{\sqrt{-\lambda}l}) + B(-e^{\sqrt{-\lambda}l}) &= 0, \\ A(e^{ikl} - e^{\sqrt{-\lambda}l}) - B(e^{ikl} - e^{-\sqrt{-\lambda}l}) &= 0 \end{aligned}$$

and we get either  $\sqrt{-\lambda} = ik + \pi mi/l$  with  $m \in \mathbb{Z}$ .

*Remark 4.2.1.* This is the simplest example of problems appearing in the description of free electrons in the crystals; much more complicated and realistic example would be Schrödinger equation

$$X'' + (\lambda - V(x))X = 0$$

or its 3D-analog.

## 4.2.2 Problems with “almost” explicit solutions

*Example 4.2.6* (Robin boundary conditions). Consider eigenvalue problem

$$X'' + \lambda X = 0 \quad 0 < x < l, \quad (4.2.27)$$

$$X'(0) = \alpha X(0), \quad X'(l) = -\beta X(l) \quad (4.2.28)$$

with  $\alpha \geq 0$ ,  $\beta \geq 0$  ( $\alpha + \beta > 0$ ). Then

$$\begin{aligned} \lambda \int_0^l X^2 dx &= - \int_0^l X'' X dx \\ &= \int_0^l X'^2 dx - X'(l)X(l) + X'(0)X(0) \\ &= \int_0^l X'^2 dx + \beta X(l)^2 + \alpha X(0)^2 \end{aligned} \quad (4.2.29)$$

and  $\lambda_n = \omega_n^2$  where  $\omega_n > 0$  are roots of

$$\tan(\omega l) = \frac{(\alpha + \beta)\omega}{\omega^2 - \alpha\beta}; \quad (4.2.30)$$

$$X_n = \omega_n \cos(\omega_n x) + \alpha \sin(\omega_n x); \quad (4.2.31)$$

( $n = 1, 2, \dots$ ). Indeed, looking for  $X = A \cos(\omega x) + B \sin(\omega x)$  with  $\omega = \sqrt{\lambda}$  (we are smarter now!) we find from the first equation of (4.2.28) that  $\omega B = \alpha A$  and we can take  $A = \omega$ ,  $B = \alpha$ ,  $X = \omega \cos(\omega x) - \alpha \sin(\omega x)$ .



Then plugging to the second equation we get

$$-\omega^2 \sin(\omega l) + \alpha \omega \cos(\omega l) = -\beta \omega \cos(\omega l) - \alpha \beta \sin(\omega l)$$

which leads us to (4.2.30)–(4.2.31).

Observe that

$$(a) \quad \alpha, \beta \rightarrow 0^+ \implies \omega_n \rightarrow \frac{\pi(n-1)}{l}.$$

$$(b) \quad \alpha, \beta \rightarrow +\infty \implies \omega_n \rightarrow \frac{\pi n}{l}.$$

$$(c) \quad \alpha \rightarrow 0^+, \beta \rightarrow +\infty \implies \omega_n \rightarrow \frac{\pi(n-\frac{1}{2})}{l}.$$

*Example 4.2.7* (Robin boundary conditions (negative eigenvalues)). However if  $\alpha$  and/or  $\beta$  are negative, one or two negative eigenvalues  $\lambda_n = -\gamma_n^2$  can also appear where

$$\tanh(\gamma_n l) = -\frac{(\alpha + \beta)\gamma_n}{\gamma_n^2 + \alpha\beta}, \quad (4.2.32)$$

$$X_n(x) = \gamma \cosh(\gamma_n x) + \alpha \sinh(\gamma_n x). \quad (4.2.33)$$

Indeed, looking for  $X = A \cosh(\gamma x) + B \sinh(\gamma x)$  with  $\gamma = \sqrt{-\lambda}$  we find from the first equation of (4.2.28) that  $\gamma B = \alpha A$  and we can take  $A = \gamma$ ,  $B = \alpha$ ,  $X = \gamma \cosh(\gamma x) - \alpha \sinh(\gamma x)$ .

Then plugging to the second equation we get

$$\gamma^2 \sinh(\gamma l) + \alpha \gamma \cosh(\gamma l) = -\beta \gamma \cosh(\gamma l) - \alpha \beta \sinh(\gamma l)$$

which leads us to (4.2.32)–(4.2.33).

To investigate when it happens, consider the threshold case of eigenvalue  $\lambda = 0$ : then  $X = cx + d$  and plugging into boundary conditions we have  $c = \alpha d$  and  $c = -\beta(d + lc)$ ; this system has non-trivial solution  $(c, d) \neq 0$  iff  $\alpha + \beta + \alpha\beta l = 0$ . This hyperbola divides  $(\alpha, \beta)$ -plane into three zones:

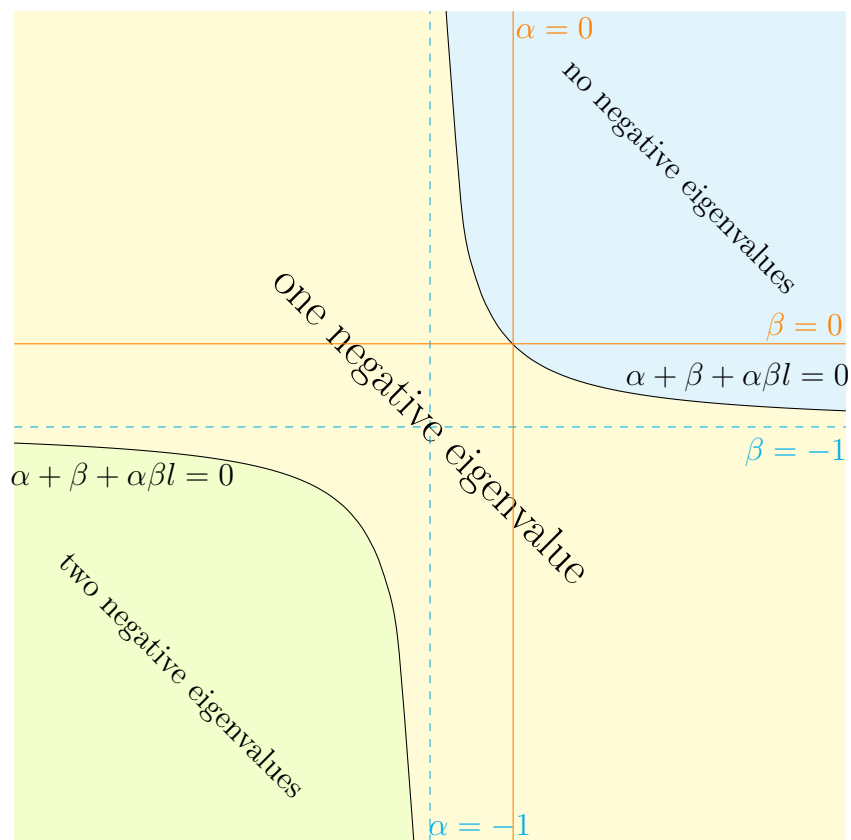

[Visual Examples \(animation\)](#)

[Visual Examples \(animation\)](#)

To calculate the number of negative eigenvalues one can either apply the general variational principle or analyze the case of  $\alpha = \beta$ ; for both approaches see Appendix 4.5.6.

*Example 4.2.8* (Oscillations of the beam). Small oscillations of the beam are described by

$$u_{tt} + Ku_{xxxx} = 0 \quad (4.2.34)$$

with the boundary conditions

$$u|_{x=0} = u_x|_{x=0} = 0, \quad (4.2.35)$$

$$u|_{x=l} = u_x|_{x=l} = 0 \quad (4.2.36)$$

(both ends are clamped) or

$$u|_{x=0} = u_x|_{x=0} = 0, \quad (4.2.37)$$

$$u_{xx}|_{x=l} = u_{xxx}|_{x=l} = 0 \quad (4.2.38)$$

(left end is clamped and the right one is free); one can also consider different and more general boundary conditions.

*Example 4.2.8* (continued). Separating variables we get

$$X^{IV} - \lambda X = 0, \quad (4.2.39)$$

$$T'' + \omega^2 T = 0, \quad \omega = \sqrt{K\lambda} \quad (4.2.40)$$

with the boundary conditions correspondingly

$$X(0) = X'(0) = 0, \quad (4.2.41)$$

$$X(l) = X'(l) = 0 \quad (4.2.42)$$

or

$$X(0) = X'(0) = 0, \quad (41)$$

$$X''(l) = X'''(l) = 0. \quad (4.2.43)$$

Eigenvalues of the both problems are positive (we skip the proof). Then  $\lambda = k^4$  and

$$X(x) = A \cosh(kx) + B \sinh(kx) + C \cos(kx) + D \sin(kx), \quad (4.2.44)$$

and (4.2.41) implies that  $C = -A$ ,  $D = -B$  and

$$X(x) = A(\cosh(kx) - \cos(kx)) + B(\sinh(kx) - \sin(kx)). \quad (4.2.45)$$

Plugging it into (4.2.42) we get

$$A(\cosh(kl) - \cos(kl)) + B(\sinh(kl) - \sin(kl)) = 0,$$

$$A(\sinh(kl) + \sin(kl)) + B(\cosh(kl) - \cos(kl)) = 0.$$

Then determinant must be 0:

$$(\cosh(kl) - \cos(kl))^2 - (\sinh^2(kl) - \sin^2(kl)) = 0$$

which is equivalent to

$$\cosh(kl) \cdot \cos(kl) = 1. \quad (4.2.46)$$

On the other hand, plugging

$$X(x) = A(\cosh(kx) - \cos(kx)) + B(\sinh(kx) - \sin(kx)) \quad (45)$$

into (4.2.43)  $X''(l) = X'''(l) = 0$  leads us to

$$\begin{aligned} A(\cosh(kl) + \cos(kl)) + B(\sinh(kl) + \sin(kl)) &= 0, \\ A(\sinh(kl) - \sin(kl)) + B(\cosh(kl) + \cos(kl)) &= 0. \end{aligned}$$

Then determinant must be 0:

$$(\cosh(kl) + \cos(kl))^2 - (\sinh^2(kl) - \sin^2(kl)) = 0$$

which is equivalent to

$$\cosh(kl) \cdot \cos(kl) = -1. \quad (4.2.47)$$

We solve (4.2.46) and (4.2.47) graphically: Case of both ends free, results

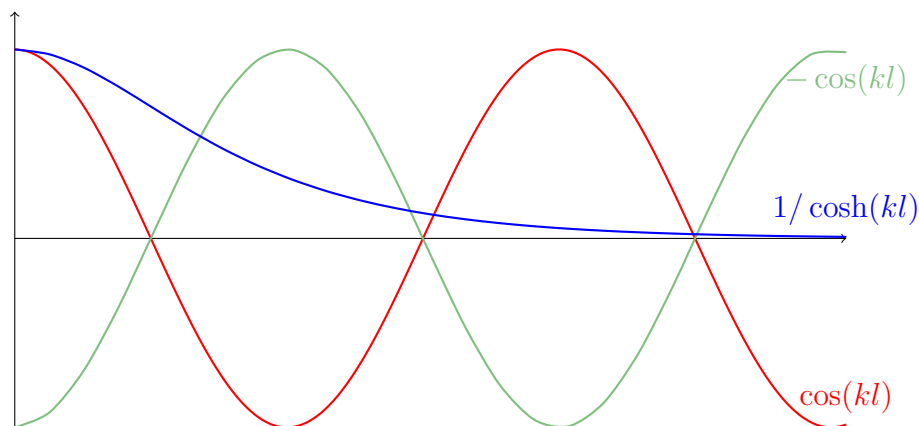

in the same eigenvalues  $\lambda_n = k_n^4$  as when both ends are clumped, but with eigenfunctions

$$X(x) = A(\cosh(kx) + \cos(kx)) + B(\sinh(kx) + \sin(kx)).$$

and also in double eigenvalue  $\lambda = 0$  and eigenfunctions 1 and  $x$ .

[Visual Examples \(animation\)](#)

## Problems to Sections 4.1 and 4.2

“Solve equation graphically” means that you plot a corresponding function and points  $(z_n, 0)$  where it intersects with  $OX$  will give us all the frequencies  $\omega_n = \omega(z_n)$ .

“Simple solution”  $u(x, t) = X(x)T(t)$ .

*Hint.* You may assume that all eigenvalues are real (which is the case). In Problems 3–8 you may assume that all eigenvalues are real and non-negative (which is also the case).

*Problem 1.* Justify Example 4.2.6 and Example 4.2.7 Consider eigenvalue problem with Robin boundary conditions

$$\begin{aligned} X'' + \lambda X &= 0 & 0 < x < l, \\ X'(0) &= \alpha X(0), \\ X'(l) &= -\beta X(l), \end{aligned}$$

with  $\alpha, \beta \in \mathbb{R}$ .

- (a) *Prove* that positive eigenvalues are  $\lambda_n = \omega_n^2$  and the corresponding eigenfunctions are  $X_n$  where  $\omega_n > 0$  are roots of

$$\tan(\omega l) = \frac{(\alpha + \beta)\omega}{\omega^2 - \alpha\beta}; \quad X_n = \omega_n \cos(\omega_n x) + \alpha \sin(\omega_n x);$$

with  $n = 1, 2, \dots$ . *Solve* this equation graphically.

- (b) *Prove* that negative eigenvalues if there are any are  $\lambda_n = -\gamma_n^2$  and the corresponding eigenfunctions are  $Y_n$  where  $\gamma_n > 0$  are roots of

$$\begin{aligned} \tanh(\gamma l) &= -\frac{(\alpha + \beta)\gamma}{\gamma^2 + \alpha\beta}, \\ Y_n(x) &= \gamma_n \cosh(\gamma_n x) + \alpha \sinh(\gamma_n x). \end{aligned}$$

*Solve* this equation graphically.

- (c) To investigate how many negative eigenvalues are, consider the threshold case of eigenvalue  $\lambda = 0$ : then  $X = cx + d$  and plugging into b.c. we have  $c = \alpha d$  and  $c = -\beta(d + lc)$ ; this system has non-trivial solution  $(c, d) \neq 0$  iff  $\alpha + \beta + \alpha\beta l = 0$ . This hyperbola divides  $(\alpha, \beta)$ -plane into three zones.
- (d) *Prove* that eigenfunctions corresponding to different eigenvalues are orthogonal:

$$\int_0^l X_n(x)X_m(x) dx = 0 \quad \text{as } \lambda_n \neq \lambda_m$$

where we consider now all eigenfunctions (no matter corresponding to positive or negative eigenvalues).

- (e) *Bonus* Prove that eigenvalues are simple, i.e. all eigenfunctions corresponding to the same eigenvalue are proportional.

*Problem 2.* Analyse the same problem albeit with Dirichlet condition on the left end:  $X(0) = 0$ .

*Problem 3.* Oscillations of the beam are described by equation

$$u_{tt} + Ku_{xxxx} = 0, \quad 0 < x < l.$$

with  $K > 0$ .

If both ends *clamped* (that means having the fixed positions and directions) then the boundary conditions are

$$\begin{aligned} u(0, t) = u_x(0, t) &= 0 \\ u(l, t) = u_x(l, t) &= 0. \end{aligned}$$

- (a) Find equation, describing frequencies, and find corresponding eigenfunctions (You may assume that all eigenvalues are real and positive).
- (b) Solve equation, describing frequencies, graphically.
- (c) Prove that eigenfunctions corresponding to different eigenvalues are orthogonal.
- (d) *Bonus.* Prove that eigenvalues are simple, i.e. all eigenfunctions corresponding to the same eigenvalue are proportional.
- (e) *Bonus.* Sketch on the computer a couple first eigenfunctions.

*Hint.* Change coordinate system so that interval becomes  $[-L, L]$  with  $L = l/2$ ; consider separately even and odd eigenfunctions.

*Problem 4.* Consider oscillations of the beam with both ends *simply supported*:

$$\begin{aligned} u(0, t) = u_{xx}(0, t) &= 0, \\ u(l, t) = u_{xx}(l, t) &= 0. \end{aligned}$$

Follow the previous problem (all parts) but also consider eigenvalue 0.

*Problem 5.* Consider oscillations of the beam with both ends free:

$$u_{xx}(0, t) = u_{xxx}(0, t) = 0, \quad (12)$$

$$u_{xx}(l, t) = u_{xxx}(l, t) = 0. \quad (13)$$

Follow previous problem but also consider eigenvalue 0.

*Problem 6.* Consider oscillations of the beam with the clamped left end and the simply supported right end. Then boundary conditions are different on the left and right ends.

*Note.* In this case due to the lack of symmetry you cannot consider separately even and odd eigenfunctions. Thee same is true for some other problems below.

*Problem 7.* Consider oscillations of the beam with the clamped left end and the free right end. Then boundary conditions are different on the left and right ends.

*Problem 8.* Consider oscillations of the beam with the simply supported left end and the free right end. Then boundary conditions are different on the left and right ends.

*Problem 9.* Consider wave equation with the Neumann boundary condition on the left and “weird” b.c. on the right:

$$\begin{aligned} u_{tt} - c^2 u_{xx} &= 0 & 0 < x < l, \\ u_x(0, t) &= 0, \\ (u_x + i\alpha u_t)(l, t) &= 0 \end{aligned}$$

with  $\alpha \in \mathbb{R}$ .

- (a) *Separate* variables;
- (b) *Find* “weird” eigenvalue problem for ODE;
- (c) *Solve* this problem;
- (d) *Find* simple solution  $u(x, t) = X(x)T(t)$ .

*Hint.* You may assume that all eigenvalues are real (which is the case).

*Problem 10.* Consider energy levels of the particle in the “rectangular well”

$$-u_{xx} + Vu = \lambda u$$

$$\text{with } V(x) = \begin{cases} -H & |x| \leq L, \\ 0 & |x| > L. \end{cases}$$

*Hint.* Solve equation for  $|x| < L$  and for  $|x| > L$  and solution must be continuous (with its first derivative) as  $|x| = L$ :  $u(L-0) = u(L+0)$ ,  $u_x(L-0) = u_x(L+0)$  and the same at  $-L$ .

*Hint.* All eigenvalues belong to interval  $(-H, 0)$ .

*Hint.* Consider separately even and odd eigenfunctions.

## 4.3 Orthogonal systems

### 4.3.1 Examples

All systems we considered in the previous Section were orthogonal i.e.

$$(X_n, X_m) = 0 \quad \forall m \neq n \quad (4.3.1)$$

with

$$(X, Y) := \int_0^l X(x)\bar{Y}(x) dx, \quad \|X\|^2 := (X, X). \quad (4.3.2)$$

where  $\bar{Y}$  means complex-conjugate to  $Y$ .

*Exercise 4.3.1.* Prove it by direct calculation.

However, instead we show that this nice property (and the fact that eigenvalues are real) is due to the fact that those problems are *self-adjoint*. Consider  $X, Y$  satisfying Robin boundary conditions

$$X'(0) - \alpha X(0) = 0, \quad (4.3.3)$$

$$X'(l) + \beta X(l) = 0 \quad (4.3.4)$$

with  $\alpha, \beta \in \mathbb{R}$  (and  $Y$  satisfies the same conditions). Note that

$$\begin{aligned} (X'', Y) &= \int X''(x)\bar{Y}(x) dx \\ &= - \int X'(x)\bar{Y}'(x) dx + X'(l)\bar{Y}(l) - X'(0)\bar{Y}(0) \\ &= - (X', Y') - \beta X(l)\bar{Y}(l) - \alpha X(0)\bar{Y}(0). \end{aligned} \quad (4.3.5)$$



Therefore if we plug  $Y = X \neq 0$  an eigenfunction,  $X'' + \lambda X = 0$ , satisfying conditions (4.3.3) and (4.3.4), we get  $-\lambda\|X\|^2$  in the left-hand expression (with obviously real  $\|X\|^2 \neq 0$ ) and also we get the real right expression (since  $\alpha, \beta \in \mathbb{R}$ ); so  $\lambda$  must be real: *all eigenvalues are real*.

Further, for  $(X, Y'')$  we obtain the same equality albeit with  $\alpha, \beta$  replaced by their complex conjugate  $\bar{\alpha}, \bar{\beta}$ :

$$(X, Y'') = \int X(x)\bar{Y}''(x) dx = -(X', Y') - \bar{\beta}X(l)\bar{Y}(l) - \bar{\alpha}X(0)\bar{Y}(0)$$

and therefore due to assumption  $\alpha, \beta \in \mathbb{R}$

$$(X'', Y) = (X, Y''). \quad (4.3.6)$$

But then if  $X, Y$  are eigenfunctions corresponding to *different* eigenvalues  $\lambda$  and  $\mu$  we get from (4.3.6) that  $-\lambda(X, Y) = -\mu(X, Y)$  and  $(X, Y) = 0$  due to  $\lambda \neq \mu$ .

*Remark 4.3.1.* For periodic boundary conditions we cannot apply these arguments to prove that  $\cos(2\pi nx/l)$  and  $\sin(2\pi nx/l)$  are orthogonal since they correspond to the same eigenvalue; we need to prove it directly.

*Remark 4.3.2.* (a) So, we observed that for the operator  $A : X \rightarrow -X''$  with the domain  $\mathfrak{D}(A) = \{X \in L^2([0, l]) : AX \in L^2([0, l]), X(0) = X(l) = 0\}$ , where  $L^p(J)$  denotes the space of functions with the finite norm  $\|X\|_{L^p(J)} = (\int_J |X|^p dx)^{1/p}$ , has the property  $(AX, Y) = (X, AY)$ . But this is not a *self-adjointness*, only a *symmetry*.

- (b) Self-adjointness means that  $A^* = A$ , and this means that the operators  $A^*$  and  $A$  have the same domain, which means that the domain of  $A^*$  is not wider, labelindent=0ptr than the domain of  $A$ . And one can see easily, that in order for  $(AX, Y) = (X, A^*Y)$  be valid for all  $X$  with  $X(0) = X(l) = 0$ , *exactly* the same conditions should be imposed on  $Y$ :  $Y(0) = Y(l) = 0$ .
- (c) On the other hand, the same operator  $A : X \rightarrow -X''$  with the domain  $\mathfrak{D}(A) = \{X \in L^2([0, l]) : AX \in L^2([0, l]), X(0) = X'(0) = X(l) = 0\}$  is only symmetric but not self-adjoint because the equality  $(AX, Y) = (X, A^*Y)$  holds for all such  $X$ , and for all  $Y$ , such that  $Y(l) = 0$ , which means that

$$\mathfrak{D}(A^*) = \{Y \in L^2([0, l]) : AY \in L^2([0, l]), Y(l) = 0\},$$

i.e. *domain of  $A^*$  is larger*. And one can check that for such operator  $A$  there are no eigenvalues and eigenfunctions at all!

So, we arrive to the following terminology

- (a) Operator  $A$  is called *symmetric*, if  $A^* \supset A$ , i.e.  $A^*$  has the same or larger domain but on domain of  $A$ , it coincides with  $A$ .
- (b) Operator  $A$  is called *self-adjoint*, if  $A^* = A$ , i.e. if both  $A$  and  $A^*$  have the same domain.

We do not formulate it as definition since we do not discuss exact definition of the adjoint operator. We need to discuss domain and the difference between symmetric and self-adjoint because operator  $X \mapsto -X''$  is *unbounded*.

### 4.3.2 Abstract orthogonal systems: definition

Consider *linear space*  $\mathbf{H}$ , real or complex. From the linear algebra course's [standard definition](#):

1.  $u + v = v + u \quad \forall u, v \in \mathbf{H}$ ;
2.  $(u + v) + w = u + (v + w) \quad \forall u, v, w \in \mathbf{H}$ ;
3.  $\exists 0 \in \mathbf{H} : 0 + u = u \quad \forall u \in \mathbf{H}$ ;
4.  $\forall u \in \mathbf{H} \exists (-u) : u + (-u) = 0$ ;
5.  $\alpha(u + v) = \alpha u + \alpha v \quad \forall u, v \in \mathbf{H} \quad \forall \alpha \in \mathbb{R}$ ;
6.  $(\alpha + \beta)u = \alpha u + \beta u \quad \forall u \in \mathbf{H} \quad \forall \alpha, \beta \in \mathbb{R}$ ;
7.  $\alpha(\beta u) = (\alpha\beta)u \quad \forall u \in \mathbf{H} \quad \forall \alpha, \beta \in \mathbb{R}$ ;
8.  $1u = u \quad \forall u \in \mathbf{H}$ .

For complex linear space replace  $\mathbb{R}$  by  $\mathbb{C}$ . Assume that on  $\mathbf{H}$  *inner product* is defined:

1.  $(u + v, w) = (u, w) + (v, w) \quad \forall u, v, w \in \mathbf{H}$ ;
2.  $(\alpha u, v) = \alpha(u, v) \quad \forall u, v \in \mathbf{H} \quad \forall \alpha \in \mathbb{C}$ ;

3.  $(u, v) = \overline{(v, u)} \quad \forall u, v \in \mathbf{H};$
4.  $\|u\|^2 := (u, u) \geq 0 \quad \forall u \in \mathbf{H}$  (it implies that it is real—if we consider complex spaces) and  $\|u\| = 0 \iff u = 0.$

**Definition 4.3.1.** (a) Finite dimensional real linear space with an inner product is called *Euclidean* space.

(b) Finite dimensional complex linear space with an inner product is called *Hermitian* space.

(c) Infinite dimensional linear space (real or complex) with an inner product is called *pre-Hilbert* space.

For *Hilbert space* we will need another property (completeness) which we add later.

**Definition 4.3.2.** (a) System  $\{u_n\}$ ,  $0 \neq u_n \in \mathbf{H}$  (finite or infinite) is *orthogonal* if  $(u_m, u_n) = 0 \quad \forall m \neq n;$

(b) Orthogonal system is *orthonormal* if  $\|u_n\| = 1 \quad \forall n$ , i.e.  $(u_m, u_n) = \delta_{mn}$  – Kronecker symbol.

### 4.3.3 Orthogonal systems: approximation

Consider a finite orthogonal system  $\{u_n\}$ . Let  $\mathbf{K}$  be its *linear hull*: the set of linear combinations  $\sum_n \alpha_n u_n$ . Obviously  $\mathbf{K}$  is a linear subspace of  $\mathbf{H}$ . Let  $v \in \mathbf{H}$  and we try to find the best approximation of  $v$  by elements of  $\mathbf{K}$ , i.e. we are looking for  $w \in \mathbf{K}$  s.t.  $\|v - w\|$  minimal.

**Theorem 4.3.1.** (i) *There exists an unique minimizer;*

(ii) *This minimizer is an orthogonal projection of  $v$  to  $\mathbf{K}$ , i.e.  $w \in \mathbf{K}$  s.t.  $(v - w)$  is orthogonal to all elements of  $\mathbf{K}$ ;*

(iii) *Such orthogonal projection is unique and  $w = \sum_n \alpha_n u_n$  with*

$$\alpha_n = \frac{(v, u_n)}{\|u_n\|^2}. \quad (4.3.7)$$

(iv)  $\|v\|^2 = \|w\|^2 + \|v - w\|^2.$

$$(v) \quad v = w \iff \|v\|^2 = \|w\|^2.$$

*Proof.* (c) Obviously  $(v - w)$  is orthogonal to  $u_n$  iff (4.3.7) holds. If (4.3.7) holds for all  $n$  then  $(v - w)$  is orthogonal to all  $u_n$  and therefore to all their linear combinations.

(d)-(e) In particular  $(v - w)$  is orthogonal to  $w$  and then

$$\|v\|^2 = \|(v - w) + w\|^2 = \|v - w\|^2 + 2 \operatorname{Re} \underbrace{(v - w, w)}_{=0} + \|w\|^2.$$

(a)-(b) Consider  $w' \in \mathbf{K}$ . Then  $\|v - w'\|^2 = \|v - w\|^2 + \|w - w'\|^2$  because  $(w - w') \in \mathbf{K}$  and therefore it is orthogonal to  $(v - w)$ . □

#### 4.3.4 Orthogonal systems: approximation. II

Now let  $\{u_n\}_{n=1,2,\dots}$  be an infinite orthogonal system. Consider its finite subsystem with  $n = 1, 2, \dots, N$ , introduce  $\mathbf{K}_N$  for it and consider orthogonal projection  $w_N$  of  $v$  on  $\mathbf{K}_N$ . Then

$$w_N = \sum_{n=1}^N \alpha_n u_n$$

where  $\alpha_n$  are defined by (4.3.7):  $\alpha_n = (v, u_n) / \|u_n\|^2$ .

Then according to Statement (iv) of Theorem 4.3.1

$$\|v\|^2 = \|v - w_N\|^2 + \|w_N\|^2 \geq \|w_N\|^2 = \sum_{n=1}^N |\alpha_n|^2 \|u_n\|^2.$$

Therefore series in the right-hand expression below converges

$$\|v\|^2 \geq \sum_{n=1}^{\infty} |\alpha_n|^2 \|u_n\|^2. \quad (4.3.8)$$

Really, recall that non-negative series can either converge or diverge to  $\infty$ .

Then  $w_N$  is a *Cauchy sequence*. Indeed, for  $M > N$

$$\|w_N - w_M\|^2 = \sum_{n=N+1}^M |\alpha_n|^2 \|u_n\|^2 \leq \varepsilon_N$$

with  $\varepsilon_N \rightarrow 0$  as  $N \rightarrow \infty$  because series in (4.3.8) converges.

Now we want to conclude that  $w_N$  converges and to do this we must assume that every Cauchy sequence converges.

**Definition 4.3.3.** (a)  $H$  is *complete* if every Cauchy sequence converges in  $H$ .

(b) Complete pre-Hilbert space is called *Hilbert space*.

*Remark 4.3.3.* Every pre-Hilbert space could be completed i.e. extended to a complete space. From now on  $H$  is a Hilbert space.

Then we can introduce  $K$  — a *closed linear hull* of  $\{u_n\}_{n=1,2,\dots}$  i.e. the space of

$$\sum_{n=1}^{\infty} \alpha_n u_n \quad (4.3.9)$$

with  $\alpha_n$  satisfying

$$\sum_{n=1}^{\infty} |\alpha_n|^2 \|u_n\|^2 < \infty. \quad (4.3.10)$$

(Linear hull would be a space of finite linear combinations).

Let  $v \in H$ . We want to find the best approximation of  $v$  by elements of  $K$ . But then we get immediately

**Theorem 4.3.2.** *If  $H$  is a Hilbert space then Theorem 4.3.1 holds for infinite systems as well.*

### 4.3.5 Orthogonal systems: completeness

**Definition 4.3.4.** Orthogonal system is *complete* if equivalent conditions below are satisfied:

- (a) Its closed convex hull coincides with  $H$ .
- (b) If  $v \in H$  is orthogonal to all  $u_n$  then  $v = 0$ .

*Remark 4.3.4.* (a) Don't confuse completeness of spaces and completeness of orthogonal systems.

- (b) Complete orthogonal system in  $H =$  *orthogonal basis* in  $H$ .

- (c) In the finite-dimensional space orthogonal system is complete iff the number of vectors equals to the dimension. Not so in the infinite-dimensional space.

Our next goal is to establish completeness of some orthogonal systems and therefore to give a positive answer (in the corresponding frameworks) to the question in the end of Section 4.3.1 *can we decompose any function into eigenfunctions? Alternatively: Is the general solution a combination of simple solutions?*

### 4.3.6 Orthogonal systems: approximation.

Now let  $\{u_n\}_{n=1,2,\dots}$  be infinite orthogonal system. Consider its finite subsystem with  $n = 1, 2, \dots, N$ , introduce  $K_N$  for it and consider orthogonal projection  $w_N$  of  $v$  on  $K_N$ . Then

$$w_N = \sum_{n=1}^N \alpha_n u_n$$

where  $\alpha_n$  are defined by (4.3.7). Then according to (d) of Theorem 4.3.1

$$\|v\|^2 = \|v - w_N\|^2 + \|w_N\|^2 \geq \|w_N\|^2 = \sum_{n=1}^N |\alpha_n|^2 \|u_n\|^2.$$

Therefore series in the right-hand expression below converges

$$\|v\|^2 \geq \sum_{n=1}^{\infty} |\alpha_n|^2 \|u_n\|^2 \quad (4.3.11)$$

Really, recall that non-negative series can either converge or diverge to  $\infty$ .

Then  $w_N$  is a *Cauchy sequence*. Really, for  $M > N$

$$\|w_N - w_M\|^2 = \sum_{n=N+1}^M |\alpha_n|^2 \|u_n\|^2 \leq \varepsilon_N$$

with  $\varepsilon_N \rightarrow 0$  as  $N \rightarrow \infty$  because series in (4.3.11) converges.

Now we want to conclude that  $w_N$  converges and to do this we must assume that every Cauchy sequence converges.

**Definition 4.3.5.** (a)  $H$  is *complete* if every Cauchy sequence converges in  $H$ .

(b) Complete pre-Hilbert space is called *Hilbert space*.

*Remark 4.3.5.* Every pre-Hilbert space could be completed i.e. extended to a complete space. From now on  $H$  is a Hilbert space.

Then we can introduce  $K$ -a closed linear hull of  $\{u_n\}_{n=1,2,\dots}$  i.e. the space of

$$\sum_{n=1}^{\infty} \alpha_n u_n \quad (4.3.12)$$

with  $\alpha_n$  satisfying

$$\sum_{n=1}^{\infty} |\alpha_n|^2 \|u_n\|^2 < \infty. \quad (4.3.13)$$

(Linear hull would be a space of finite linear combinations).

Let  $v \in H$ . We want to find the best approximation of  $v$  by elements of  $K$ . But then we get immediately

**Theorem 4.3.3.** *If  $H$  is a Hilbert space then Theorem 4.3.1 holds for infinite systems as well.*

## 4.4 Orthogonal systems and Fourier series

### 4.4.1 Formulae

Consider *trigonometric system* of functions

$$\left\{ \frac{1}{2}, \quad \cos\left(\frac{\pi n x}{l}\right), \quad \sin\left(\frac{\pi n x}{l}\right) \quad n = 1, \dots \right\} \quad (4.4.1)$$

on interval  $J := [x_0, x_1]$  with  $(x_1 - x_0) = 2l$ .

These are *eigenfunctions* of  $X'' + \lambda X = 0$  with *periodic boundary conditions*  $X(x_0) = X(x_1)$ ,  $X'(x_0) = X'(x_1)$ .

Let us first establish this is *orthogonal system*.

**Proposition 4.4.1.**

$$\begin{aligned}\int_J \cos\left(\frac{\pi m x}{l}\right) \cos\left(\frac{\pi n x}{l}\right) dx &= l \delta_{mn}, \\ \int_J \sin\left(\frac{\pi m x}{l}\right) \sin\left(\frac{\pi n x}{l}\right) dx &= l \delta_{mn}, \\ \int_J \cos\left(\frac{\pi m x}{l}\right) \sin\left(\frac{\pi n x}{l}\right) dx &= 0,\end{aligned}$$

and

$$\int_J \cos\left(\frac{\pi m x}{l}\right) dx = 0, \quad \int_J \sin\left(\frac{\pi m x}{l}\right) dx = 0, \quad \int_J dx = 2l$$

for all  $m, n = 1, 2, \dots$

*Proof.* Easy; use formulae

$$\begin{aligned}2 \cos(\alpha) \cos(\beta) &= \cos(\alpha - \beta) + \cos(\alpha + \beta), \\ 2 \sin(\alpha) \sin(\beta) &= \cos(\alpha - \beta) - \cos(\alpha + \beta), \\ 2 \sin(\alpha) \cos(\beta) &= \sin(\alpha - \beta) + \sin(\alpha + \beta).\end{aligned}$$

□

Therefore according to the previous Section 4.3 we arrive to decomposition

$$f(x) = \frac{1}{2}a_0 + \sum_{n=1}^{\infty} \left( a_n \cos\left(\frac{\pi n x}{l}\right) + b_n \sin\left(\frac{\pi n x}{l}\right) \right) \quad (4.4.2)$$

with coefficients calculated according to (4.3.7)

$$a_n = \frac{1}{l} \int_J f(x) \cos\left(\frac{\pi n x}{l}\right) dx \quad n = 0, 1, 2, \dots, \quad (4.4.3)$$

$$b_n = \frac{1}{l} \int_J f(x) \sin\left(\frac{\pi n x}{l}\right) dx \quad n = 1, 2, \dots, \quad (4.4.4)$$

and satisfying *Parseval's equality*

$$\frac{l}{2}|a_0|^2 + \sum_{n=1}^{\infty} l(|a_n|^2 + |b_n|^2) = \int_J |f(x)|^2 dx. \quad (4.4.5)$$



*Exercise 4.4.1.* (a) Prove formulae (4.4.2)–(4.4.5) based on (4.3.7) and Proposition 4.4.1.

(b) Also prove it only based on Proposition 4.4.1, that means without norms, inner products (just do all calculations from the scratch).

So far this is an *optional* result: provided we can decompose function  $f(x)$ .

## 4.4.2 Completeness of the trigonometric system

Now our goal is to prove that any function  $f(x)$  on  $J$  could be decomposed into Fourier series

$$f(x) = \frac{1}{2}a_0 + \sum_{n=1}^{\infty} \left( a_n \cos\left(\frac{\pi nx}{l}\right) + b_n \sin\left(\frac{\pi nx}{l}\right) \right) \quad (2)$$

First we need

**Definition 4.4.1.** (a)  $f(x)$  is *piecewise-continuous function* on  $J = [a, b]$  if for some  $a = x_0 < x_1 < \dots < x_K = b$  function  $f(x)$  is continuous on  $(x_k, x_{k+1})$  and limits  $\lim_{x \rightarrow x_k^+} f(x)$  and  $\lim_{x \rightarrow x_{k+1}^-} f(x)$  exist;  $k = 0, 1, \dots, N - 1$ .

(b) Further,  $f(x)$  is *piecewise-continuously differentiable function*, if it is continuously differentiable on  $(x_k, x_{k+1})$  and limits  $\lim_{x \rightarrow x_k^+} f'(x)$  and  $\lim_{x \rightarrow x_{k+1}^-} f'(x)$  exist;  $k = 0, 1, \dots, N - 1$ .

**Lemma 4.4.2.** *Let  $f(x)$  be a piecewise-continuous function on  $J$ . Then*

$$\int_J f(x) \cos(\omega x) dx \rightarrow 0 \quad \text{as } \omega \rightarrow \infty \quad (4.4.6)$$

and the same is true for  $\cos(\omega x)$  replaced by  $\sin(\omega x)$ .

*Proof.* (a) Assume first that  $f(x)$  is continuously differentiable on  $J$ . Then integrating by parts

$$\begin{aligned} & \int_J f(x) \cos(\omega x) dx \\ &= \omega^{-1} f(x) \sin(\omega x) \Big|_{x_0}^{x_1} - \omega^{-1} \int_J f'(x) \sin(\omega x) dx = O(\omega^{-1}). \end{aligned}$$

(b) Assume now only that  $f(x)$  is continuous on  $J$ . Then it could be uniformly approximated by continuous functions (proof is not difficult but we skip it anyway):

$$\forall \varepsilon > 0 \exists f_\varepsilon \in C^1(J): \quad \forall x \in J |f(x) - f_\varepsilon(x)| \leq \varepsilon.$$

Then obviously the difference between integrals (4.4.6) for  $f$  and for  $f_\varepsilon$  does not exceed  $2l\varepsilon$ ; so choosing  $\varepsilon = \varepsilon(\delta) = \delta/(4l)$  we make it  $< \delta/2$ . After  $\varepsilon$  is chosen and  $f_\varepsilon$  fixed we can choose  $\omega_\varepsilon$  s.t. for  $\omega > \omega_\varepsilon$  integral (4.4.6) for  $f_\varepsilon$  does not exceed  $\delta/2$  in virtue of (a). Then the absolute value of integral (4.4.6) for  $f$  does not exceed  $\delta$ .

(c) Integral (4.4.6) for interval  $J$  equals to the sum of integrals over intervals where  $f$  is continuous. □

Now calculate coefficients according to (4.4.3)-(4.4.4) (albeit plug  $y$  instead of  $x$ )

$$a_n = \frac{1}{l} \int_J f(y) \cos\left(\frac{\pi ny}{l}\right) dy \quad n = 0, 1, 2, \dots, \quad (4.4.3)$$

$$b_n = \frac{1}{l} \int_J f(y) \sin\left(\frac{\pi ny}{l}\right) dy \quad n = 1, 2, \dots, \quad (4.4.4)$$

and plug into partial sum:

$$S_N(x) = \frac{1}{2}a_0 + \sum_{n=1}^N \left( a_n \cos\left(\frac{\pi nx}{l}\right) + b_n \sin\left(\frac{\pi nx}{l}\right) \right) = \frac{1}{l} \int_J K_N(x, y) f(y) dy, \quad (4.4.7)$$

$$K_N(x, y) = \frac{1}{2} + \sum_{n=1}^N \left( \cos\left(\frac{\pi ny}{l}\right) \cos\left(\frac{\pi nx}{l}\right) + \sin\left(\frac{\pi ny}{l}\right) \sin\left(\frac{\pi nx}{l}\right) \right) = \frac{1}{2} + \sum_{n=1}^N \cos\left(\frac{\pi n(y-x)}{l}\right). \quad (4.4.8)$$

Note that

$$\sum_{n=1}^N \sin\left(\frac{z}{2}\right) \cos(nz) = \sum_{n=1}^N \left( \sin\left(\left(n + \frac{1}{2}\right)z\right) - \sin\left(\left(n - \frac{1}{2}\right)z\right) \right) = \sin\left(\left(N + \frac{1}{2}\right)z\right) - \sin\left(\frac{1}{2}z\right)$$

and therefore

$$K_N(x, y) = \frac{\sin\left(k\left(N + \frac{1}{2}\right)(x - y)\right)}{\sin(k(x - y))}, \quad k = \frac{\pi}{l}. \quad (4.4.9)$$

Therefore

$$S_N(x) = \frac{1}{l} \int_J \frac{\sin\left(k\left(N + \frac{1}{2}\right)(x - y)\right)}{\sin(k(x - y))} f(y) dy \quad (4.4.10)$$

However, we cannot apply Lemma 4.4.2 to this integral immediately because of the denominator:

$$S_N(x) = \frac{1}{l} \int_J \frac{\sin\left(k\left(N + \frac{1}{2}\right)(x - y)\right)}{\sin(k(x - y))} f(y) dy \quad (4.4.11)$$

Assume that  $x$  is internal point of  $J$ . Note that denominator vanishes on  $J$  only as  $y = x$ . Indeed,  $\frac{\pi}{2l}(x - y) < \pi$ . Also note that derivative of denominator does not vanish as  $y = x$ . Then  $\frac{f(y)}{\sin(k(x - y))}$  is a piecewise continuous function of  $y$  provided *all three conditions below are fulfilled*:

- (a)  $f$  is piecewise continuously differentiable function;
- (b)  $f$  is continuous in  $x$  (we are talking about a *single point*  $x$ )
- (c) and  $f(x) = 0$ .

In this case we can apply Lemma 4.4.2 and we conclude that  $S_N(x) \rightarrow 0$  as  $N \rightarrow \infty$ . So, *If  $f$  satisfies (a)–(c) then  $S_N(x) \rightarrow f(x)$  as  $N \rightarrow \infty$ .*

Let us drop condition  $f(x) = 0$ . Then we can decompose

$$S_N(x) = \frac{1}{l} \int_J \frac{\sin\left(k\left(N + \frac{1}{2}\right)(x - y)\right)}{\sin(k(x - y))} (f(y) - f(x)) dy + \frac{1}{l} \int_J \frac{\sin\left(k\left(N + \frac{1}{2}\right)(x - y)\right)}{\sin(k(x - y))} f(x) dy \quad (4.4.12)$$

and the first integral tends to 0 due to Lemma 4.4.2. We claim that the second integral is identically equal  $f(x)$ . Indeed, we can move  $f(x)$  out of integral and consider

$$\begin{aligned} \frac{1}{l} \int_J \frac{\sin(k(N + \frac{1}{2})(x - y))}{\sin(k(x - y))} dy = \\ \frac{1}{l} \int_J \left( \frac{1}{2} + \sum_{n=1}^N \cos\left(\frac{\pi n(y - x)}{l}\right) \right) dy \end{aligned} \quad (4.4.13)$$

where integral of the first term equals  $l$  and integral of all other terms vanish.

### 4.4.3 Pointwise convergence

Therefore we arrive to

**Theorem 4.4.3.** *Let  $x$  be internal point of  $J$  (i.e.  $x_0 < x < x_1$ ) and let*

- (i)  *$f$  be a piecewise continuously differentiable function;*
- (ii)  *$f$  be continuous in  $x$ .*

*Then the Fourier series converges to  $f(x)$  at  $x$ .*

### 4.4.4 Pointwise convergence. II

Assume now that there is a jump at  $x$ . Then we need to be more subtle.

First, we can replace  $f(x)$  by its  $2l$ -periodic continuation from  $J$  to  $\mathbb{R}$ . Then we can take *any interval of the length  $2l$*  and result will be the same.

So we take  $[x - l, x + l]$ . Now

$$\begin{aligned} S_N(x) &= \frac{1}{l} \int_{J^-} \frac{\sin(k(N + \frac{1}{2})(x - y))}{\sin(k(x - y))} (f(y) - f(x^-)) dy \\ &+ \frac{1}{l} \int_{J^+} \frac{\sin(k(N + \frac{1}{2})(x - y))}{\sin(k(x - y))} (f(y) - f(x^+)) dy \\ &+ \frac{1}{l} \int_{J^-} \frac{\sin(k(N + \frac{1}{2})(x - y))}{\sin(k(x - y))} f(x^-) dy \\ &+ \frac{1}{l} \int_{J^+} \frac{\sin(k(N + \frac{1}{2})(x - y))}{\sin(k(x - y))} f(x^+) dy \end{aligned}$$

with  $f(x^\pm) := \lim_{y \rightarrow x^\pm} f(y)$  and  $J^- = (x - l, l)$ ,  $J^+ = (x, x + l)$ .

According to Lemma 4.4.2 again the first two integrals tend to 0 and we need to consider two integrals

$$\frac{1}{l} \int_{J^-} \frac{\sin(k(N + \frac{1}{2})(x - y))}{\sin(k(x - y))} dy,$$

$$\frac{1}{l} \int_{J^+} \frac{\sin(k(N + \frac{1}{2})(x - y))}{\sin(k(x - y))} dy.$$

Using back transformation like in (4.4.12) :

$$\frac{1}{l} \int_{J^\pm} \frac{\sin(k(N + \frac{1}{2})(x - y))}{\sin(k(x - y))} dy = \frac{1}{l} \int_{J^\pm} \left( \frac{1}{2} + \sum_{n=1}^N \cos\left(\frac{\pi n(y - x)}{l}\right) \right) dy$$

we conclude that both these integrals are equal to  $\frac{1}{2}$ .

Therefore we proved

**Theorem 4.4.4.** *Let  $f$  be a piecewise continuously differentiable function. Then the Fourier series converges to*

- (i)  $f(x)$  if  $x$  is internal point and  $f$  is continuous at  $x$ ;
- (ii)  $\frac{1}{2}(f(x^+) + f(x^-))$  if  $x$  is internal point and  $f$  is discontinuous at  $x$ ;
- (iii)  $\frac{1}{2}(f(x_0^+) + f(x_1^-))$  if  $x = x_0$  or  $x = x_1$ . Recall that  $x_0$  and  $x_1$  are the ends.

The last two statements are called *Gibbs phenomenon*. Below are partial sums of sin-Fourier decomposition of  $u(x) = \begin{cases} 1 & -\pi < x < 0, \\ -1 & 0 < x < \pi. \end{cases}$

*Remark 4.4.1.* (a) One can prove that in the framework of Theorem 4.4.4 the convergence is uniform on every segment  $[\alpha, \beta]$  not containing jumps of  $2l$ -periodic continuation of  $f(x)$ .

- (b) This implies convergence by  $L^2$ -norm  $\|f\| := \left( \int_0^l |f(x)|^2 dx \right)^{1/2}$ .

Recall from Calculus I that  $f_N(x) \rightarrow f(x)$  uniformly, if

$$\forall \varepsilon \exists N = N(\varepsilon): |f_N(x) - f(x)| < \varepsilon \forall x \forall N > N(\varepsilon).$$

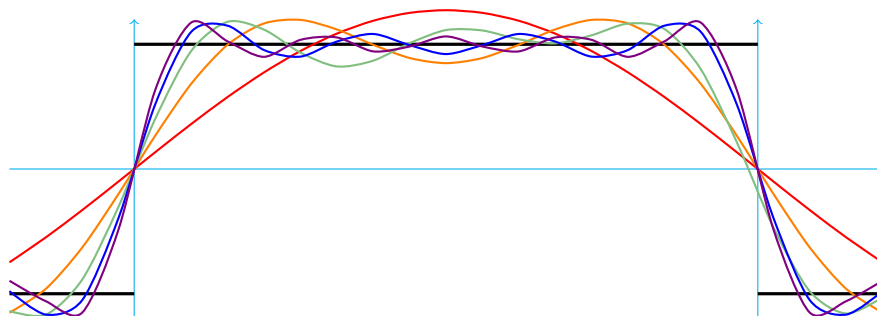

## 4.5 Other Fourier series

### 4.5.1 Fourier series for even and odd functions

In the previous Section 4.4 we proved the completeness of the system of functions

$$\left\{ \frac{1}{2}, \quad \cos\left(\frac{\pi nx}{l}\right), \quad \sin\left(\frac{\pi nx}{l}\right) \quad n = 1, \dots \right\} \quad (4.5.1)$$

on interval  $J := [x_0, x_1]$  with  $(x_1 - x_0) = 2l$ . In other words, we proved that any function  $f(x)$  on this interval could be decomposed into Fourier series

$$f(x) = \frac{1}{2}a_0 + \sum_{n=1}^{\infty} \left( a_n \cos\left(\frac{\pi nx}{l}\right) + b_n \sin\left(\frac{\pi nx}{l}\right) \right) \quad (4.5.2)$$

with coefficients calculated according to (4.3.7)

$$a_n = \frac{1}{l} \int_J f(x) \cos\left(\frac{\pi nx}{l}\right) dx \quad n = 0, 1, 2, \dots, \quad (4.5.3)$$

$$b_n = \frac{1}{l} \int_J f(x) \sin\left(\frac{\pi nx}{l}\right) dx \quad n = 1, 2, \dots, \quad (4.5.4)$$

and satisfying Parseval's equality

$$\frac{l}{2}|a_0|^2 + \sum_{n=1}^{\infty} l(|a_n|^2 + |b_n|^2) = \int_J |f(x)|^2 dx. \quad (4.5.5)$$

Now we consider some other orthogonal systems and prove their completeness. To do this we first prove

**Lemma 4.5.1.** *Let  $J$  be a symmetric interval:  $J = [-l, l]$ . Then*

(i)  $f(x)$  is even iff  $b_n = 0 \quad \forall n = 1, 2, \dots$

(ii)  $f(x)$  is odd iff  $a_n = 0 \quad \forall n = 0, 1, 2, \dots$

*Proof.* (i) Note that  $\cos(\frac{\pi nx}{l})$  are even functions and  $\sin(\frac{\pi nx}{l})$  are odd functions.

(a) Therefore if  $b_n = 0 \quad \forall n = 1, 2, \dots$  then decomposition

$$f(x) = \frac{1}{2}a_0 + \sum_{n=1}^{\infty} (a_n \cos(\frac{\pi nx}{l}) + b_n \sin(\frac{\pi nx}{l}))$$

contains only even functions and  $f(x)$  is even.

(b) Conversely, if  $f(x)$  is an even function then integrand in

$$b_n = \frac{1}{l} \int_J f(x) \sin(\frac{\pi nx}{l}) dx \quad n = 1, 2, \dots,$$

is an odd function and its integral over symmetric interval is 0.

(ii) Statement (ii) is proven in the similar way.

□

### 4.5.2 cos-Fourier series

Let us consider function  $f(x)$  on the interval  $[0, l]$ . Let us extend it as an *even* function on  $[-l, l]$  so  $f(x) := f(-x)$  for  $x \in [-l, 0]$  and decompose it into full Fourier series (4.5.2);

however, sin-terms disappear and we arrive to decomposition

$$f(x) = \frac{1}{2}a_0 + \sum_{n=1}^{\infty} a_n \cos(\frac{\pi nx}{l}). \quad (4.5.6)$$

This is decomposition with respect to orthogonal system

$$\left\{ \frac{1}{2}, \quad \cos(\frac{\pi nx}{l}) \quad n = 1, \dots \right\}. \quad (4.5.7)$$

Its coefficients are calculated according to (4.5.3) but here integrands are even functions and we can take interval  $[0, l]$  instead of  $[-l, l]$  and double integrals:

$$a_n = \frac{2}{l} \int_0^l f(x) \cos(\frac{\pi nx}{l}) dx \quad n = 0, 1, 2, \dots \quad (4.5.8)$$

Also Parseval's equality (4.5.5) becomes

$$\frac{l}{4}|a_0|^2 + \sum_{n=1}^{\infty} \frac{l}{2}|a_n|^2 = \int_0^l |f(x)|^2 dx. \quad (4.5.9)$$

The sum of this Fourier series is  $2l$ -periodic. Note that even and then periodic continuation does not introduce new jumps.

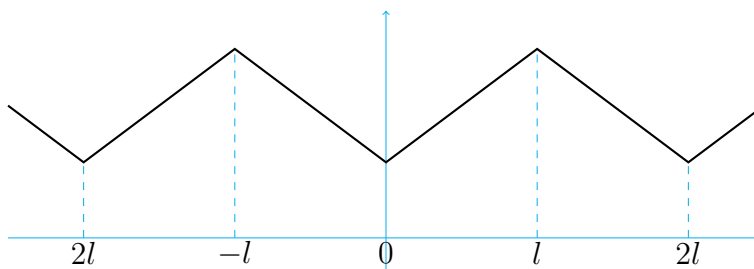

### 4.5.3 sin-Fourier series

Let us consider function  $f(x)$  on the interval  $[0, l]$ . Let us extend it as an *odd* function on  $[-l, l]$  so  $f(x) := -f(-x)$  for  $x \in [-l, 0]$  and decompose it into full Fourier series (4.5.2); however, cos-terms disappear and we arrive to decomposition

$$f(x) = \sum_{n=1}^{\infty} b_n \sin\left(\frac{\pi n x}{l}\right). \quad (4.5.10)$$

This is decomposition with respect to orthogonal system

$$\left\{ \sin\left(\frac{\pi n x}{l}\right) \quad n = 1, \dots \right\}. \quad (4.5.11)$$

Its coefficients are calculated according to (4.5.4) but here integrands are even functions and we can take interval  $[0, l]$  instead of  $[-l, l]$  and double integrals:

$$b_n = \frac{2}{l} \int_0^l f(x) \sin\left(\frac{\pi n x}{l}\right) dx \quad n = 1, 2, \dots \quad (4.5.12)$$

Also Parseval's equality (4.5.5) becomes

$$\sum_{n=1}^{\infty} \frac{l}{2}|b_n|^2 = \int_0^l |f(x)|^2 dx. \quad (4.5.13)$$

The sum of this Fourier series is  $2l$ -periodic. Note that odd and then periodic continuation does not introduce new jumps iff  $f(0) = f(l) = 0$ .



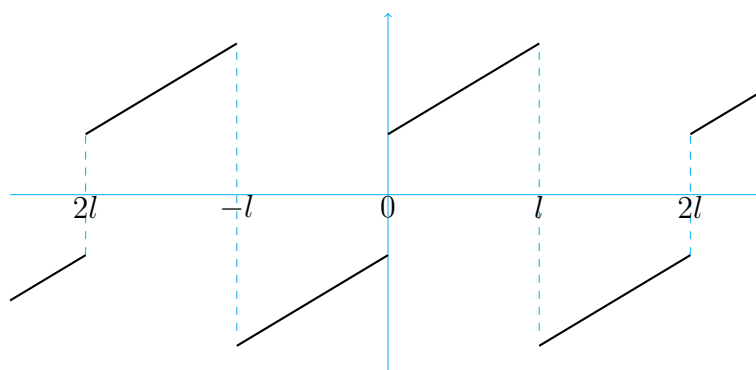

(a) General case

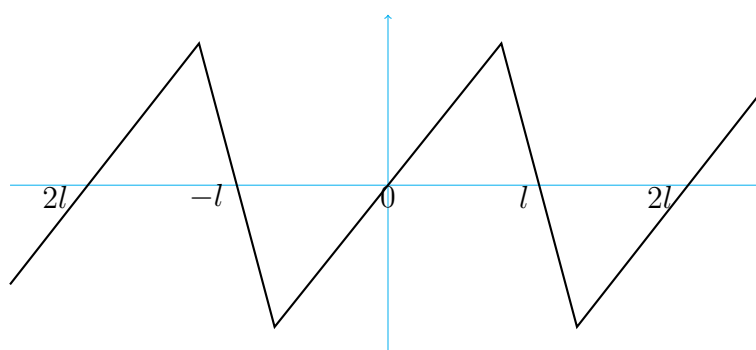
(b)  $f(0) = f(l) = 0$ 

#### 4.5.4 sin-Fourier series with half-integers

Let us consider function  $f(x)$  on the interval  $[0, l]$ . Let us extend it as an *even with respect to  $x = l$*  function on  $[0, 2l]$  so  $f(x) := f(2l - x)$  for  $x \in [l, 2l]$ ; then we make an *odd continuation to  $[-2l, 2l]$*  and decompose it into full Fourier series (4.5.2) but with  $l$  replaced by  $2l$ ; however, cos-terms disappear and we arrive to decomposition

$$f(x) = \sum_{n=1}^{\infty} b'_n \sin\left(\frac{\pi n x}{2l}\right).$$

Then  $f(2l - x) = \sum_{n=1}^{\infty} b'_n \sin\left(\frac{\pi n x}{2l}\right)(-1)^{n+1}$  and since  $f(x) = f(2l - x)$  due to original even continuation we conclude that  $b'_n = 0$  as  $n = 2m$  and we arrive to

$$f(x) = \sum_{n=0}^{\infty} b_n \sin\left(\frac{\pi(2n+1)x}{2l}\right) \quad (4.5.14)$$

with  $b_n := b'_{2n+1}$  where we replaced  $m$  by  $n$ .

This is decomposition with respect to orthogonal system

$$\left\{ \sin\left(\frac{\pi(2n+1)x}{2l}\right) \quad n = 1, \dots \right\}. \quad (4.5.15)$$

Its coefficients are calculated according to (4.5.12) (with  $l$  replaced by  $2l$ ) but here we can take interval  $[0, l]$  instead of  $[0, 2l]$  and double integrals:

$$b_n = \frac{2}{l} \int_0^l f(x) \sin\left(\frac{\pi(2n+1)x}{2l}\right) dx \quad n = 0, 1, 2, \dots \quad (4.5.16)$$

Also Parseval's equality (4.5.13) becomes

$$\sum_{n=0}^{\infty} \frac{l}{2} |b_n|^2 = \int_0^l |f(x)|^2 dx. \quad (4.5.17)$$

The sum of this Fourier series is  $4l$ -periodic. Note that odd and then periodic continuation does not introduce new jumps iff  $f(0) = 0$ .

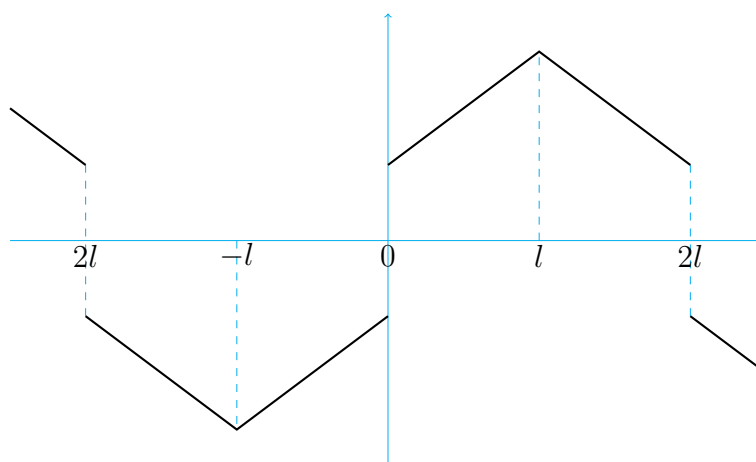

(a) General case

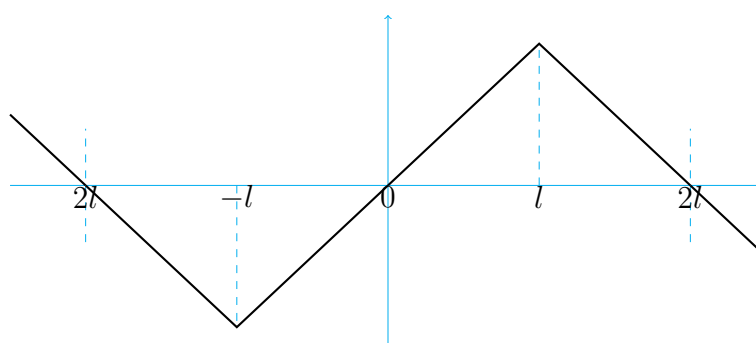

(b)  $f(0) = 0$

### 4.5.5 Fourier series in complex form

Consider (4.5.2)–(4.5.5). Plugging

$$\begin{aligned}\cos\left(\frac{\pi nx}{l}\right) &= \frac{1}{2}e^{\frac{i\pi nx}{l}} + \frac{1}{2}e^{-\frac{i\pi nx}{l}} \\ \sin\left(\frac{\pi nx}{l}\right) &= \frac{1}{2i}e^{\frac{i\pi nx}{l}} - \frac{1}{2i}e^{-\frac{i\pi nx}{l}}\end{aligned}$$

and separating terms with  $n$  and  $-n$  and replacing in the latter  $-n$  by  $n = -1, -2, \dots$  we get

$$f(x) = \sum_{n=-\infty}^{\infty} c_n e^{\frac{i\pi nx}{l}} \quad (4.5.18)$$

with  $c_0 = \frac{1}{2}a_0$ ,  $c_n = \frac{1}{2}(a_n - ib_n)$  as  $n = 1, 2, \dots$  and  $c_n = \frac{1}{2}(a_{-n} + ib_{-n})$  as  $n = -1, -2, \dots$  which could be written as

$$c_n = \frac{1}{2l} \int_J f(x) e^{-\frac{i\pi nx}{l}} dx \quad n = \dots, -2, -1, 0, 1, 2, \dots \quad (4.5.19)$$

Parseval's equality (4.5.5) becomes

$$2l \sum_{n=-\infty}^{\infty} |c_n|^2 = \int_J |f(x)|^2 dx. \quad (4.5.20)$$

One can see easily that the system

$$\left\{ X_n := e^{\frac{i\pi nx}{l}} \quad \dots, -2, -1, 0, 1, 2, \dots \right\} \quad (4.5.21)$$

on interval  $J := [x_0, x_1]$  with  $(x_1 - x_0) = 2l$  is orthogonal:

$$\int_J X_n(x) \bar{X}_m(x) dx = 2l \delta_{mn}. \quad (4.5.22)$$

*Remark 4.5.1.* (a) All our formulae are due to Section 4.3 but *we need the completeness of the systems* and those are due to *completeness of the full trigonometric system (4.5.1)* established in Section 4.4.

- (b) Recall that with periodic boundary conditions all eigenvalues  $(\frac{\pi n}{l})^2$ ,  $n \neq 0$  are of multiplicity 2 i.e. the corresponding *eigenspace* (consisting of all eigenfunctions with the given eigenvalue) has dimension 2 and  $\{\cos(\frac{\pi nx}{l}), \sin(\frac{\pi nx}{l})\}$  and  $\{e^{\frac{i\pi nx}{l}}, e^{-\frac{i\pi nx}{l}}\}$  are just two different orthogonal bases in this eigenspace.

- (c) Fourier series in the complex form are from  $-\infty$  to  $\infty$  and this means that *both sums*  $\sum_{n=0}^{\pm\infty} c_n e^{\frac{i\pi n x}{l}}$  must converge which is a stronger requirement than convergence of Fourier series in the trigonometric form. For piecewise differentiable function  $f$  Fourier series in the complex form converges at points where  $f$  is continuous but not at jump points where such series converges *only in the sense of principal value*:

$$\lim_{N \rightarrow +\infty} \sum_{n=-N}^{n=N} c_n e^{\frac{i\pi n x}{l}} = \frac{1}{2} (f(x^+) + f(x^-)). \quad (4.5.23)$$

### 4.5.6 Miscellaneous

We consider in appendices

1. Appendix 4.B. Multidimensional Fourier series
2. Appendix 4.C. Harmonic oscillator

### Problems to Sections 4.3–4.5

Some of the problems in this assignment could be solved based on the other problems and such solutions are much shorter than from the scratch; seeing and exploiting connections is a plus.

Here  $\mathbb{N} = \{1, 2, 3, \dots\}$ ,

*Problem 1.* Decompose into full Fourier series on interval  $[-l, l]$ :

- (a)  $e^{zx}$  where  $z \in \mathbb{C}$ ; find “exceptional” values of  $z$ ;
- (b)  $\cos(\omega x)$ ,  $\sin(\omega x)$  where  $0 < \omega \in \mathbb{R}$ ; find “exceptional” values of  $\omega$ ;
- (c)  $\cosh(\eta x)$ ,  $\sinh(\eta x)$  where  $0 < \eta \in \mathbb{R}$ ;

*Problem 2.* Decompose into full Fourier series on interval  $[-l, l]$  and sketch the graph of the sum of such Fourier series:

- (a)  $x$ ;
  - (b)  $|x|$ ;
  - (c)  $x^2$ .
- (d) For problem (b) with  $l = 5$  plot 4 first partial sums like on the figure in the end of Section 4.4.

*Problem 3.* Decompose into full Fourier series on interval  $[-\pi, \pi]$  and sketch the graph of the sum of such Fourier series:

- (a)  $|\sin(x)|$ ; (b)  $|\cos(x)|$ .

*Problem 4.* Decompose into sin-Fourier series on interval  $[0, \pi]$  and sketch the graph of the sum of such Fourier series:

- (a) 1; (d)  $\sin(mx)$  with  $m \in \mathbb{N}$ ;  
 (b)  $x$ ; (e)  $\cos(mx)$  with  $m \in \mathbb{N}$ ;  
 (c)  $x(\pi - x)$ ; (f)  $\sin((m - \frac{1}{2})x)$  with  $m \in \mathbb{N}$ .

*Problem 5.* Decompose into cos-Fourier series on interval  $[0, \pi]$  and sketch the graph of the sum of such Fourier series:

- (a) 1; (d)  $\sin(mx)$  with  $m \in \mathbb{N}$ ;  
 (b)  $x$ ; (e)  $\cos(mx)$  with  $m \in \mathbb{N}$ ;  
 (c)  $x(\pi - x)$ ; (f)  $\sin((m - \frac{1}{2})x)$  with  $m \in \mathbb{N}$ .

*Problem 6.* Decompose into Fourier series with respect to  $\sin((n + \frac{1}{2})x)$  ( $n = 0, 1, \dots$ ) on interval  $[0, \pi]$  and sketch the graph of the sum of such Fourier series:

- (a) 1; (d)  $\sin(mx)$  with  $m \in \mathbb{N}$ ;  
 (b)  $x$ ; (e)  $\cos(mx)$  with  $m \in \mathbb{N}$ ;  
 (c)  $x(\pi - x)$ ; (f)  $\sin((m - \frac{1}{2})x)$  with  $m \in \mathbb{N}$ .

*Problem 7.* Using Fourier method find all solutions to the following problem in the square

$$\begin{aligned} 4u_{xx} - 9u_{yy} &= 0, & 0 < x < \pi, \quad 0 < y < \pi, \\ u|_{y=0} &= u|_{y=\pi} = 0, \\ u|_{x=0} &= u|_{x=\pi} = 0. \end{aligned}$$

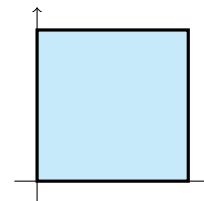

*Problem 8.* Using Fourier method find all solutions to the following problem in the square

$$\begin{aligned}\Delta u + 5u &= 0, & 0 < x < \pi, \quad 0 < y < \pi, \\ u|_{y=0} &= u|_{y=\pi} = 0, \\ u|_{x=0} &= u|_{x=\pi} = 0.\end{aligned}$$

*Problem 9.* Using Fourier method find all solutions to the following problem in the square

$$\begin{aligned}u_{xx} - 5u_{yy} &= 0, & 0 < x < \pi, \quad 0 < y < \pi, \\ u|_{y=0} &= u|_{y=\pi} = 0, \\ u|_{x=0} &= u|_{x=\pi} = 0.\end{aligned}$$

*Problem 10.* Using Fourier method find all solutions to the following problem in the square

$$\begin{aligned}4u_{xx} - 8u_{yy} &= 0, & 0 < x < \pi, \quad 0 < y < \pi, \\ u_y|_{y=0} &= u_y|_{y=\pi} = 0, \\ u_x|_{x=0} &= u_x|_{x=\pi} = 0.\end{aligned}$$

*Problem 11.* Using Fourier method find all solutions to the following problem in the square

$$\begin{aligned}u_{xx} + u_{yy} + 5u &= 0, & 0 < x < \pi, \quad 0 < y < \pi, \\ u|_{y=0} &= u_y|_{y=\pi} = 0, \\ u|_{x=0} &= u_x|_{x=\pi} = 0.\end{aligned}$$

*Problem 12.* Using Fourier method find all solutions to the following problem in the square

$$\begin{aligned}u_{xx} + u_{yy} + 2u &= 0, & 0 < x < \pi, \quad 0 < y < \pi, \\ u|_{y=0} &= u_y|_{y=\pi} = 0, \\ u|_{x=0} &= u_x|_{x=\pi} = 0.\end{aligned}$$

*Problem 13.* Using Fourier method find all solutions to the following problem in the rectangle

$$\begin{aligned} u_{xx} - u_{yy} &= 0, & 0 < x < 3\pi, \quad 0 < y < 4\pi, \\ u|_{y=0} &= u|_{y=4\pi} = 0, \\ u|_{x=0} &= u|_{x=3\pi} = 0. \end{aligned}$$

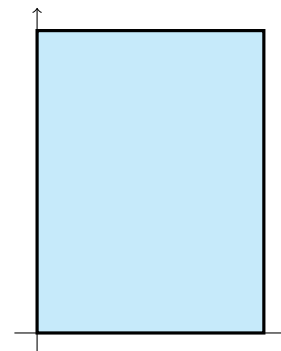

*Hint.* In the problems in the triangle use method of continuation from the triangle to the square.

*Problem 14.* Using Fourier method find all solutions to the following problem in the triangle  $\{(x, y) : 0 < x < y < \pi\}$

$$\begin{aligned} u_{xx} + u_{yy} + 2u &= 0, & 0 < x < y < \pi, \\ u|_{y=\pi} &= 0, \\ u|_{x=0} &= 0, \\ u|_{x=y} &= 0. \end{aligned}$$

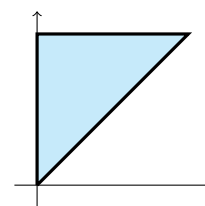

*Problem 15.* Using Fourier method find all solutions to the following problem in the triangle  $\{(x, y) : 0 < x < y < \pi\}$

$$\begin{aligned} u_{xx} + u_{yy} + 5u &= 0, & 0 < x < y < \pi, \\ u|_{y=\pi} &= 0, \\ u|_{x=0} &= 0, \\ u|_{x=y} &= 0. \end{aligned}$$

*Problem 16.* Using Fourier method find all solutions to the following problem in the triangle  $\{(x, y) : 0 < x < y < \pi\}$

$$\begin{aligned} u_{xx} + u_{yy} + 5u &= 0, & 0 < x < y < \pi, \\ u_y|_{y=\pi} &= 0, \\ u_x|_{x=0} &= 0, \\ u|_{x=y} &= 0. \end{aligned}$$

*Problem 17.* Using Fourier method find all solutions to the following problem in the triangle  $\{(x, y): 0 < x < y < \pi\}$

$$\begin{aligned} u_{xx} + u_{yy} + 5u &= 0, & 0 < x < y < \pi, \\ u_y|_{y=\pi} &= 0, \\ u_x|_{x=0} &= 0, \\ (u_x - u_y)|_{x=y} &= 0. \end{aligned}$$

## Appendix 4.A. Negative eigenvalues in Robin problem

### Variational approach

Analyzing Example 4.2.6 and Example 4.2.7. We claim that

**Theorem 4.A.1.** *Eigenvalues are monotone functions of  $\alpha, \beta$ .*

To prove it we need without proof to accept variational description of eigenvalues of self-adjoint operators bounded from below (very general theory) which in this case reads as:

**Theorem 4.A.2.** *Consider quadratic forms*

$$Q(u) = \int_0^l |u'|^2 dx + \alpha|u(0)|^2 + \beta|u(l)|^2 \quad (4.A.24)$$

and

$$P(u) = \int_0^l |u|^2 dx. \quad (4.A.25)$$

*Then there are at least  $N$  eigenvalues which are less than  $\lambda$  if and only iff there is a subspace  $\mathbf{K}$  of dimension  $N$  on which quadratic form*

$$Q_\lambda(u) = Q(u) - \lambda P(u) \quad (4.A.26)$$

*is negative definite (i.e.  $Q_\lambda(u) < 0$  for all  $u \in \mathbf{K}, u \neq 0$ ).*

Note that  $Q(u)$  is monotone non-decreasing function of  $\alpha, \beta$ . Therefore  $N(\lambda)$  (the exact number of e.v. which are less than  $\lambda$ ) is monotone non-increasing function of  $\alpha, \beta$  and therefore  $\lambda_N$  is monotone non-decreasing function of  $\alpha, \beta$ .



**Case  $\alpha = \beta$** 

The easiest way to deal with it would be to note that the hyperbola  $\alpha + \beta + \alpha\beta l = 0$  has two branches and divides plane into 3 regions and due to continuity of eigenvalue in each of them the number of negative eigenvalues is the same.

Consider  $\beta = \alpha$ , it transects all three regions. Shift coordinate  $x$  to the center of interval, which becomes  $[-L, L]$ ,  $L = l/2$ . Now problem becomes

$$X'' + \lambda X = 0, \quad (4.A.27)$$

$$X'(-L) = \alpha X(-L), \quad (4.A.28)$$

$$X'(L) = -\alpha X(L) \quad (4.A.29)$$

and therefore if  $X$  is an eigenfunction, then  $Y(x) := X(-x)$  is an eigenfunction with the same eigenvalue.

Therefore we can consider separately eigenfunctions which are even functions, and which are odd functions—and those are described respectively by

$$X'' + \lambda X = 0, \quad (4.A.30)$$

$$X'(0) = 0, \quad (4.A.31)$$

$$X'(L) = -\alpha X(L) \quad (4.A.32)$$

and

$$X'' + \lambda X = 0, \quad (4.A.33)$$

$$X(0) = 0, \quad (4.A.34)$$

$$X'(L) = -\alpha X(L). \quad (4.A.35)$$

Since we are looking at  $\lambda = -\gamma^2$  ( $\gamma > 0$ ), we look at  $X = \cosh(x\gamma)$  and  $X = \sinh(x\gamma)$  respectively (see conditions (4.A.31), (4.A.34)) and then conditions (4.A.32), (4.A.35) tell us that

$$\alpha L = -(L\gamma) \tanh(L\gamma), \quad (4.A.36)$$

$$\alpha L = -(L\gamma) \coth(L\gamma) \quad (4.A.37)$$

respectively.

Both functions  $z \tanh(z)$  and  $z \coth(z)$  are monotone increasing for  $z > 0$  with minima at  $z = 0$  equal 0 and 1 respectively. Thus equation (4.A.36)

has a single solution  $\gamma$  iff  $\alpha < 0$  and (4.A.37) has a single solution  $\gamma$  iff  $\alpha L < -1$ .

Therefore as  $\alpha l < 0$  there is one negative eigenvalue with an even eigenfunction and as  $2\alpha l + (\alpha l)^2 < 0$  comes another negative eigenvalue with an odd eigenfunction.

Sure, one can apply a variational arguments above but analysis above has its own merit (mainly learning).

## Appendix 4.B. Multidimensional Fourier series

### $2\pi$ -periodic Case

Let function  $u(\mathbf{x})$ ,  $\mathbf{x} = (x_1, x_2, \dots, x_n)$  be  $2\pi$ -periodic with respect to each variable  $x_1, x_2, \dots, x_n$ . Then

$$u(\mathbf{x}) = \sum_{\mathbf{m} \in \mathbb{Z}^n} c_{\mathbf{m}} e^{i\mathbf{m} \cdot \mathbf{x}} \quad (4.B.38)$$

with

$$c_{\mathbf{m}} = (2\pi)^{-n} \iiint_{\Omega} e^{-i\mathbf{m} \cdot \mathbf{x}} u(\mathbf{x}) d^n x \quad (4.B.39)$$

and

$$\sum_{\mathbf{m} \in \mathbb{Z}^n} |c_{\mathbf{m}}|^2 = (2\pi)^{-n} \iiint_{\Omega} |u(\mathbf{x})|^2 d^n x \quad (4.B.40)$$

where  $\Omega = (0, 1)^n$  is  $n$ -dimensional unit cube. Here and below we write  $n$ -dimensional integral as  $\iiint$ .

Those formulae follows by repetition of what we have in 1-dimensional case: we simply make Fourier series decomposition by  $x_1$ , then by  $x_2$  and so on  $\dots$ ; for example, for  $n = 2$

$$\begin{aligned} u(x, y) &= \sum_{m \in \mathbb{Z}} u_m(y) e^{ixm}, & u_m(y) &= (2\pi)^{-1} \int_0^{2\pi} u(x, y) e^{-imx} dx, \\ u_m(y) &= \sum_{n \in \mathbb{Z}} c_{mn} e^{iny}, & c_{mn} &= (2\pi)^{-1} \int_0^{2\pi} u_m(y) e^{-iny} dy \\ \implies u(x, y) &= \sum_{(m,n) \in \mathbb{Z}^2} c_{mn} e^{imx+iny}, & c_{mn} &= (2\pi)^{-2} \iint_{[0,2\pi]^2} u(x, y) e^{-imx-iny} dx dy. \end{aligned}$$

We need slightly generalize these formulae.

### General case

**Definition 4.B.1.** Let  $\Gamma$  be  $n$ -dimensional lattice. It means that there are  $n$  linearly independent vectors  $\mathbf{e}_1, \dots, \mathbf{e}_n$  and

$$\Gamma = \{k_1 \mathbf{e}_1 + k_2 \mathbf{e}_2 + \dots + k_n \mathbf{e}_n : k_1, k_2, \dots, k_n \in \mathbb{Z}\} \quad (4.B.41)$$

*Remark 4.B.1.* The same lattice  $\Gamma$  is defined by vectors  $\mathbf{e}'_1, \dots, \mathbf{e}'_n$  with  $\mathbf{e}'_j = \sum_k \alpha_{jk} \mathbf{e}_k$  with integer coefficients if and only if the determinant of the matrix  $(\alpha_{jk})_{j,k=1,\dots,n}$  of coefficients is equal  $\pm 1$ .

**Definition 4.B.2.** Let  $\Gamma$  be  $n$ -dimensional lattice. We call  $u(\mathbf{x})$  *periodic with respect to  $\Gamma$*  or simply  $\Gamma$ -periodic if

$$u(\mathbf{x} + \mathbf{y}) = u(\mathbf{x}) \quad \forall \mathbf{y} \in \Gamma \quad \forall \mathbf{x}. \quad (4.B.42)$$

In the Subsection 4.B.1  $\Gamma = (2\pi\mathbb{Z})^n$ . Let us change coordinate system so that  $\Gamma$  becomes  $(2\pi\mathbb{Z})^n$ , apply (4.B.38)–(4.B.40) and then change coordinate system back. We get

$$u(\mathbf{x}) = \sum_{\mathbf{m} \in \Gamma^*} c_{\mathbf{m}} e^{i\mathbf{m} \cdot \mathbf{x}} \quad (4.B.43)$$

with

$$c_{\mathbf{m}} = |\Omega|^{-1} \iiint_{\Omega} e^{-i\mathbf{m} \cdot \mathbf{x}} u(\mathbf{x}) d^n x \quad (4.B.44)$$

and

$$\sum_{\mathbf{m} \in \Gamma^*} |c_{\mathbf{m}}|^2 = |\Omega|^{-1} \iiint_{\Omega} |u(\mathbf{x})|^2 d^n x \quad (4.B.45)$$

where  $|\Omega|$  is a volume of  $\Omega$  and

**Definition 4.B.3.** (a)  $\Omega = \{x_1 \mathbf{e}_1 + \dots + x_n \mathbf{e}_n : 0 < x_1 < 1, \dots, 0 < x_n < 1\}$  is an *elementary cell*;

(b)  $\Gamma^* = \{\mathbf{m} : \mathbf{m} \cdot \mathbf{y} \in 2\pi\mathbb{Z} \quad \forall \mathbf{y} \in \Gamma\}$  is a *dual lattice*; it could be defined by vectors  $\mathbf{e}_1^*, \dots, \mathbf{e}_n^*$  such that

$$\mathbf{e}_j^* \cdot \mathbf{e}_k = 2\pi \delta_{jk} \quad \forall j, k = 1, \dots, n \quad (4.B.46)$$

where  $\delta_{jk}$  is a Kronecker symbol;

(c)  $\Omega^* = \{k_1 \mathbf{e}_1^* + \dots + k_n \mathbf{e}_n^* : 0 < k_1 < 1, \dots, 0 < k_n < 1\}$  is a *dual elementary cell*.

*Remark 4.B.2.* We prefer to use original coordinate system rather than one with coordinate vectors  $(2\pi)^{-1} \mathbf{e}_1, \dots, (2\pi)^{-1} \mathbf{e}_n$  because the latter is not necessarily orthonormal and in it Laplacian will have a different form.

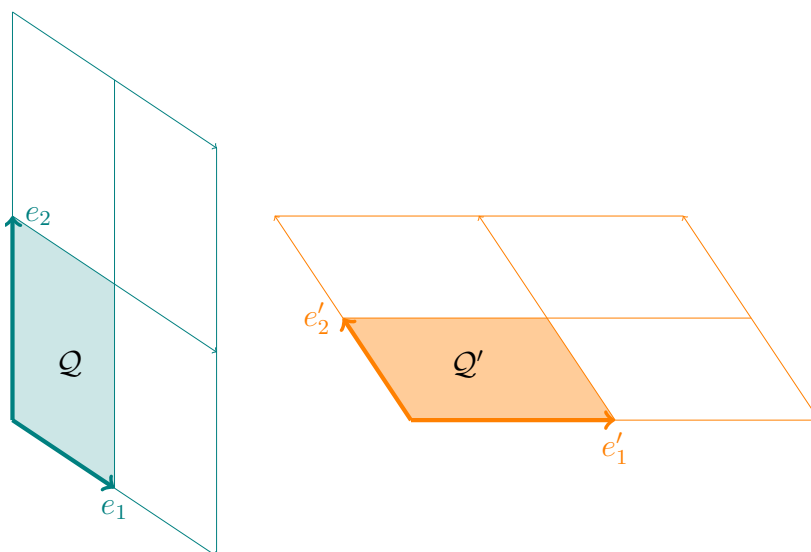

Figure : Lattice and elementary cell (teal) and dual lattice and dual elementary cell (orange)

### Special decomposition

These notions are important for studying the *band spectrum* of the Schrödinger operator  $-\Delta + V(\mathbf{x})$  with periodic (with respect to some lattice  $\Gamma$ ) potential in the whole space which has applications to the Physics of crystals. For this the following decomposition is used for functions  $u(\mathbf{x})$  in the whole space  $\mathbb{R}^n$ .

**Theorem 4.B.1.** *Let  $u(\mathbf{x})$  be sufficiently fast decaying function on  $\mathbb{R}^n$ . Then*

$$u(\mathbf{x}) = \iiint_{\Omega^*} u(\mathbf{k}; \mathbf{x}) d^n \mathbf{k} \quad (4.B.47)$$

with

$$u(\mathbf{k}; \mathbf{x}) = (2\pi)^{-n} |\Omega| \sum_{\mathbf{l} \in \Gamma} e^{-i\mathbf{k} \cdot \mathbf{l}} u(\mathbf{x} + \mathbf{l}). \quad (4.B.48)$$

Here  $u(\mathbf{k}; \mathbf{x})$  is quasiperiodic with quasimomentum  $\mathbf{k}$

$$u(\mathbf{k}; \mathbf{x} + \mathbf{y}) = e^{i\mathbf{k} \cdot \mathbf{y}} u(\mathbf{k}; \mathbf{x}) \quad \forall \mathbf{y} \in \Gamma \quad \forall \mathbf{x}. \quad (4.B.49)$$

*Proof.* Observe that since  $u$  is sufficiently fast decaying series in (4.B.48) converges and one can see easily that it defines quasiperiodic with quasimomentum  $\mathbf{k}$  function.

The proof of (4.B.47) is trivial because

$$\iiint_{\Omega^*} e^{-i\mathbf{k}\cdot\mathbf{l}} d^n \mathbf{k} = \begin{cases} |\Omega^*| & \mathbf{l} = 0, \\ 0 & 0 \neq \mathbf{l} \in \Gamma \end{cases}$$

and  $|\Omega^*| = (2\pi)^n |\Omega|^{-1}$ .  $\square$

*Remark 4.B.3.* Since choice of vectors  $\mathbf{e}_1, \dots, \mathbf{e}_n$  for given lattice  $\Gamma$  is not unique, the choice of  $\Omega$  and  $\Omega^*$  is not unique either, but  $|\Omega|$  is defined uniquely.

## Appendix 4.C. Harmonic oscillator

**Definition 4.C.1.** *Quantum harmonic oscillator* is an operator on  $\mathbb{R}$

$$L := -\frac{1}{2}\partial_x^2 + \frac{1}{2}x^2 \quad (4.C.1)$$

It is defined in the space  $L^2(\mathbb{R})$  of square integrable functions on  $\mathbb{R}$ .

*Remark 4.C.1.* Operator

$$L_{\alpha\beta} := -\frac{\alpha^2}{2}\partial_x^2 + \frac{\beta^2}{2}x^2 \quad (4.C.2)$$

can be reduced to (4.C.1) by change of variables  $x := x\gamma$  with  $\gamma = \sqrt{\beta/\alpha}$  and division by  $\sqrt{\alpha\beta}$ .

Observe that

$$L = \frac{1}{2}Z^*Z + \frac{1}{2} = \frac{1}{2}ZZ^* - \frac{1}{2} \quad (4.C.3)$$

with

$$Z := \partial_x + x, \quad Z^* = -\partial_x + x \quad (4.C.4)$$

and  $Z^*$  is adjoint to  $Z$ :  $(Zu, v) = (u, Z^*v)$ .

Note that (4.C.3) implies that the lowest eigenvalue of  $L$  is  $\frac{1}{2}$  with eigenfunction which is “annihilated” by  $Z$ , i.e.  $u_0(x) := e^{-\frac{x^2}{2}}$ .

To find other eigenvalues and eigenfunctions observe that  $[Z^*, Z] = -2$  and therefore

$$LZ^* = Z^*(L + 1), \quad LZ = Z(L - 1). \quad (4.C.5)$$

The first equality implies that if  $u$  is an eigenfunction with an eigenvalue  $\lambda$ , then  $Z^*u$  is an eigenfunction with an eigenvalue  $\lambda + 1$ ; therefore we have a sequence of eigenvalues  $\lambda_n = (n + \frac{1}{2})$ ,  $n = 0, 1, 2, \dots$  and eigenfunctions  $u_n$  defined

$$u_n = Z^*u_{n-1}, \quad n = 1, 2, \dots \quad (4.C.6)$$

**Theorem 4.C.1.** (i) *There are no other than above eigenvalues and eigenfunctions;*

(ii)  $u_n(x) = H_n(x)e^{-\frac{x^2}{2}}$  where  $H_n(x)$  is a polynomial of degree  $n$  (and it is even/odd for even/odd  $n$ );

(iii) All  $u_n(x)$  are orthogonal;  $\|u_n\| = \sqrt{\pi n!}$ .

(iv) System  $\{u_n\}$  is complete.

*Proof.* (i) The second of equalities (4.C.5)  $LZ = Z(L - 1)$  implies that if  $u$  is an eigenfunction with an eigenvalue  $\lambda$ , then  $Zu$  is an eigenfunction with an eigenvalue  $\lambda - 1$ ; however, since eigenvalues start from  $\frac{1}{2}$  there are no eigenvalues in  $(\frac{1}{2}, \frac{3}{2})$ ; so the next eigenvalue is  $\frac{3}{2}$  and if  $u$  is a corresponding eigenfunction then  $Zu = cu_0$ . But then  $Z^*Zu = cZ^*u_0$ ; but  $Z^*Zu = (L - \frac{1}{2})u = u$  and  $u = cZ^*u_0 = cu_1$ . Continuing these arguments we conclude that there are no eigenvalues in  $(\frac{3}{2}, \frac{5}{2})$ ; so the next eigenvalue is  $\frac{5}{2}$  and  $u = c_2$  and so on.

(ii) By induction.

(iii) Due to  $L^* = L$  functions are orthogonal; on the other hand

$$\begin{aligned} \|u_n\|^2 &= \|Z^*u\|^2 = (Z^*u_{n-1}, Z^*u_{n-1}) = \\ &= (ZZ^*u, u) = ((L + \frac{1}{2})u_{n-1}, u_{n-1}) = (\lambda + \frac{1}{2})\|u_{n-1}\|^2 = n\|u\|^2 \end{aligned}$$

and by induction it is equal to  $n!\|u_0\|^2 = n!\pi$ .

Here we used the fact that  $\|u_0\|^2 = \int_{-\infty}^{\infty} e^{-x^2} dx = \pi$ .

(iv) Beyond our reach. □

**Definition 4.C.2.** Functions  $u_n$  are *Hermite functions*,  $H_n(x)$  are *Hermite polynomials*.

One can prove

$$H_n(x) = n! \sum_{m=0}^{\lfloor \frac{n}{2} \rfloor} \frac{(-1)^m}{m!(n-2m)!} (2x)^{n-2m}. \quad (4.C.7)$$

Then

$$H_0(x) = 1,$$

$$H_1(x) = 2x,$$

$$H_2(x) = 4x^2 - 2,$$

$$H_3(x) = 8x^3 - 12x,$$

$$H_4(x) = 16x^4 - 48x^2 + 12,$$

$$H_5(x) = 32x^5 - 160x^3 + 120x,$$

$$H_6(x) = 64x^6 - 480x^4 + 720x^2 - 120,$$

$$H_7(x) = 128x^7 - 1344x^5 + 3360x^3 - 1680x,$$

$$H_8(x) = 256x^8 - 3584x^6 + 13440x^4 - 13440x^2 + 1680,$$

$$H_9(x) = 512x^9 - 9216x^7 + 48384x^5 - 80640x^3 + 30240x,$$

$$H_{10}(x) = 1024x^{10} - 23040x^8 + 161280x^6 - 403200x^4 + 302400x^2 - 30240$$

*Remark 4.C.2.* In the toy-model of QFT (Quantum Field Theory)  $u_n$  is considered as  $n$ -particle state, in particular  $u_0$  is a vacuum state; operators  $a = \frac{1}{\sqrt{2}}Z$  and  $a^+ = \frac{1}{\sqrt{2}}Z^*$  are operators of annihilation and creation respectively,  $N = a^+a = L - \frac{1}{2}$  is an operator of number of the particles (actually, it is true only for bosons).

## References

1. [http://en.wikipedia.org/wiki/Hermite\\_polynomials](http://en.wikipedia.org/wiki/Hermite_polynomials)
2. <http://mathworld.wolfram.com/HermitePolynomial.html>

See plots for Hermite polynomial and Hermite functions. Observe that  $H_n(x)$  changes sign exactly  $n$ -times.



# Chapter 5

## Fourier transform

In this Chapter we consider Fourier transform which is the most useful of all integral transforms.

### 5.1 Fourier transform, Fourier integral

#### 5.1.1 Heuristics

In Section 4.5 we wrote Fourier series in the complex form

$$f(x) = \sum_{n=-\infty}^{\infty} c_n e^{\frac{i\pi n x}{l}} \quad (5.1.1)$$

with

$$c_n = \frac{1}{2l} \int_{-l}^l f(x) e^{-\frac{i\pi n x}{l}} dx \quad n = \dots, -2, -1, 0, 1, 2, \dots \quad (5.1.2)$$

and

$$2l \sum_{n=-\infty}^{\infty} |c_n|^2 = \int_{-l}^l |f(x)|^2 dx. \quad (5.1.3)$$

From this form we *formally*, without any justification, will deduct Fourier integral.

First we introduce

$$k_n := \frac{\pi n}{l} \quad \text{and} \quad \Delta k_n = k_n - k_{n-1} = \frac{\pi}{l} \quad (5.1.4)$$

and rewrite (5.1.1) as

$$f(x) = \sum_{n=-\infty}^{\infty} C(k_n) e^{ik_n x} \Delta k_n \quad (5.1.5)$$

with

$$C(k) = \frac{1}{2\pi} \int_{-l}^l f(x) e^{-ikx} dx \quad (5.1.6)$$

where we used  $C(k_n) := c_n/(\Delta k_n)$ ; equality (5.1.3)

$$2\pi \sum_{n=-\infty}^{\infty} |C(k_n)|^2 \Delta k_n. \quad (5.1.7)$$

Now we *formally* set  $l \rightarrow +\infty$ ; then integrals from  $-l$  to  $l$  in the right-hand expression of (5.1.6) and the left-hand expression of (5.1.7) become integrals from  $-\infty$  to  $+\infty$ .

Meanwhile,  $\Delta k_n \rightarrow +0$  and *Riemannian sums* in the right-hand expressions of (5.1.5) and (5.1.7) become integrals:

$$f(x) = \int_{-\infty}^{\infty} C(k) e^{ikx} dk \quad (5.1.8)$$

with

$$C(k) = \frac{1}{2\pi} \int_{-\infty}^{\infty} f(x) e^{-ikx} dx; \quad (5.1.9)$$

Meanwhile (5.1.3) becomes

$$\int_{-\infty}^{\infty} |f(x)|^2 dx = 2\pi \int_{-\infty}^{\infty} |C(k)|^2 dk. \quad (5.1.10)$$

## 5.1.2 5.1.2. Definitions and remarks

**Definition 5.1.1.** (a) Formula (5.1.9) gives us a *Fourier transform* of  $f(x)$ , it usually is denoted by “hat”:

$$\hat{f}(k) = \frac{1}{2\pi} \int_{-\infty}^{\infty} f(x) e^{-ikx} dx; \quad (\text{FT})$$

sometimes it is denoted by “tilde” ( $\tilde{f}$ ), and seldom just by a corresponding capital letter  $F(k)$ .

- (b) Expression (5.1.8) is a *Fourier integral* a.k.a. *inverse Fourier transform*:

$$f(x) = \int_{-\infty}^{\infty} \hat{f}(k)e^{ikx} dk \quad (\text{FI})$$

a.k.a.

$$\check{F}(x) = \int_{-\infty}^{\infty} F(k)e^{ikx} dk \quad (\text{IFT})$$

*Remark 5.1.1.* Formula (5.1.10) is known as *Plancherel theorem*

$$\int_{-\infty}^{\infty} |f(x)|^2 dx = 2\pi \int_{-\infty}^{\infty} |\hat{f}(k)|^2 dk. \quad (\text{PT})$$

*Remark 5.1.2.* (a) Sometimes exponents of  $\pm ikx$  is replaced by  $\pm 2\pi ikx$  and factor  $1/(2\pi)$  dropped.

- (b) Sometimes factor  $\frac{1}{\sqrt{2\pi}}$  is placed in both Fourier transform and Fourier integral:

$$\hat{f}(k) = \frac{1}{\sqrt{2\pi}} \int_{-\infty}^{\infty} f(x)e^{-ikx} dx; \quad (\text{FT}^*)$$

$$f(x) = \frac{1}{\sqrt{2\pi}} \int_{-\infty}^{\infty} \hat{f}(k)e^{ikx} dk. \quad (\text{FI}^*)$$

Then FT and IFT differ only by  $i$  replaced by  $-i$  and Plancherel theorem becomes

$$\int_{-\infty}^{\infty} |f(x)|^2 dx = \int_{-\infty}^{\infty} |\hat{f}(k)|^2 dk. \quad (\text{PT}^*)$$

In this case Fourier transform and inverse Fourier transform differ only by  $-i$  instead of  $i$  (very symmetric form) and both are *unitary operators*. In all assignments indicate which form of F.T. you use!

*Remark 5.1.3.* We can consider corresponding operator  $LX = -X''$  in the space  $L^2(\mathbb{R})$  of the square integrable functions on  $\mathbb{R}$ .

- (a) However,  $e^{ikx}$  are no more eigenfunctions since they do not belong to this space. Correspondingly,  $k^2$  with  $k \in \mathbb{R}$  are not eigenvalues. In advanced Real Analysis such functions and numbers often are referred as *generalized eigenfunctions* and *generalized eigenvalues*.

- (b) The generalized eigenvalues which are not eigenvalues form *continuous spectrum* in contrast to *point spectrum* formed by eigenvalues.
- (c) Physicists often omit word “generalized”.
- (d) More details in Section 13.4.

*Remark 5.1.4.* (a) For justification see Appendix 5.1.3.

- (b) Pointwise convergence of Fourier integral is discussed in Section 5.1.3.
- (c) Multidimensional Fourier transform and Fourier integral are discussed in Appendix 5.2.5.
- (d) Fourier transform in the complex domain (for those who took “Complex Variables”) is discussed in Appendix 5.2.5.
- (e) Fourier Series interpreted as Discrete Fourier transform are discussed in Appendix 5.2.5.

### 5.1.3 cos- and sin-Fourier transform and integral

Applying the same arguments as in Section 4.5 we can rewrite formulae (5.1.8)–(5.1.10) as

$$f(x) = \int_0^{\infty} (A(k) \cos(kx) + B(k) \sin(kx)) dk \quad (5.1.11)$$

with

$$A(k) = \frac{1}{\pi} \int_{-\infty}^{\infty} f(x) \cos(kx) dx, \quad (5.1.12)$$

$$B(k) = \frac{1}{\pi} \int_{-\infty}^{\infty} f(x) \sin(kx) dx, \quad (5.1.13)$$

and

$$\int_{-\infty}^{\infty} |f(x)|^2 dx = \pi \int_0^{\infty} (|A(k)|^2 + |B(k)|^2) dk. \quad (5.1.14)$$

$A(k)$  and  $B(k)$  are cos- and sin- Fourier transforms and

- (a)  $f(x)$  is even function iff  $B(k) = 0$ .

(b)  $f(x)$  is odd function iff  $A(k) = 0$ .

Therefore

(a) Each function on  $[0, \infty)$  could be decomposed into cos-Fourier integral

$$f(x) = \int_0^{\infty} A(k) \cos(kx) dk \quad (5.1.15)$$

with

$$A(k) = \frac{2}{\pi} \int_0^{\infty} f(x) \cos(kx) dx. \quad (5.1.16)$$

(b) Each function on  $[0, \infty)$  could be decomposed into sin-Fourier integral

$$f(x) = \int_0^{\infty} B(k) \sin(kx) dk \quad (5.1.17)$$

with

$$B(k) = \frac{2}{\pi} \int_0^{\infty} f(x) \sin(kx) dx. \quad (5.1.18)$$

### Appendix 5.1.A. Justification

Let  $u(x)$  be smooth fast decaying function; let us decompose it as in [Section 4.B](#) (but now we are in the simpler 1-dimensional framework and  $\Gamma = 2\pi\mathbb{Z}$ ):

$$u(x) = \int_0^1 u(k; x) dk \quad (5.1.A.1)$$

with

$$u(k; x) = \sum_{m=-\infty}^{\infty} e^{-2\pi k m i} u(x + 2\pi m). \quad (5.1.A.2)$$

Here  $u(k; x)$  is *quasiperiodic with quasimomentum  $k$*

$$u(k; x + 2\pi n) = e^{2\pi n k i} u(k; x) \quad \forall n \in \mathbb{Z} \quad \forall x \in \mathbb{R}. \quad (5.1.A.3)$$

Indeed,

$$\begin{aligned} u(k; x + 2\pi n) &= \sum_{m=-\infty}^{\infty} e^{-2\pi k m i} u(x + 2\pi(m+n)) \stackrel{m:=m+n}{=} \\ &= \sum_{m=-\infty}^{\infty} e^{-2\pi k(m-n)i} u(x + 2\pi m) = e^{2\pi n k i} u(k; x). \end{aligned}$$

Then  $e^{-ikx}u(k; x)$  is periodic and one can decompose it into Fourier series

$$u(k; x) = \sum_{n=-\infty}^{\infty} e^{inx} e^{ikx} c_n(k) = \sum_{n=-\infty}^{\infty} e^{i(n+k)x} c_n(k) \quad (5.1.A.4)$$

(where we restored  $u(k; x)$  multiplying by  $e^{ikx}$ ) with

$$c_n(k) = \frac{1}{2\pi} \int_0^{2\pi} e^{-i(n+k)x} u(k; x) dx \quad (5.1.A.5)$$

and

$$2\pi \sum_{n=-\infty}^{\infty} |c_n(k)|^2 = \int_0^{2\pi} |u(k; x)|^2 dx. \quad (5.1.A.6)$$

Plugging (5.1.A.4) into (5.1.A.1), that is

$$u(k; x) = \sum_{n=-\infty}^{\infty} e^{i(n+k)x} c_n(k), \quad u(x) = \int_0^1 u(k; x) dk,$$

we get

$$\begin{aligned} u(x) &= \int_0^1 \sum_{n=-\infty}^{\infty} c_n(k) e^{i(n+k)x} dk = \sum_{n=-\infty}^{\infty} \int_n^{n+1} C(\omega) e^{i\omega x} d\omega \\ &= \int_{-\infty}^{\infty} C(\omega) e^{i\omega x} d\omega \end{aligned}$$

where  $C(\omega) := c_n(k)$  with  $n = \lfloor \omega \rfloor$  and  $k = \omega - \lfloor \omega \rfloor$  which are respectively integer and fractional parts of  $\omega$ . So, we got decomposition of  $u(x)$  into Fourier integral.

Next, plugging (5.1.A.2) into (5.1.A.5), that is

$$u(k; x) = \sum_{m=-\infty}^{\infty} e^{-2\pi k m i} u(x + 2\pi m), \quad c_n(k) = \frac{1}{2\pi} \int_0^{2\pi} e^{-i(n+k)x} u(k; x) dx,$$

we get

$$\begin{aligned} C(\omega) &= \frac{1}{2\pi} \int_0^{2\pi} e^{-i\omega x} \sum_{m=-\infty}^{\infty} e^{-2\pi i k m} u(x + 2\pi m) dx = \\ &= \frac{1}{2\pi} \int_{2\pi m}^{2\pi(m+1)} e^{-i\omega y} u(y) dy = \int_{-\infty}^{2\pi} e^{-i\omega y} u(y) dy \end{aligned}$$

where we set  $y = x + 2\pi m$ . So, we got exactly formula for Fourier transform.

Finally, (5.1.A.6), that is

$$2\pi \sum_{n=-\infty}^{\infty} |c_n(k)|^2 = \int_0^{2\pi} |u(k; x)|^2 dx,$$

implies

$$2\pi \sum_{n=-\infty}^{\infty} \int_0^1 |c_n(k)|^2 dk = \int_0^{2\pi} \left( \int_0^1 |u(k; x)|^2 dk \right) dx$$

where the left hand expression is exactly

$$2\pi \sum_{n=-\infty}^{\infty} \int_n^{n+1} |C(\omega)|^2 d\omega = 2\pi \int_{-\infty}^{\infty} |C(\omega)|^2 d\omega$$

and the right hand expression is

$$\int_0^{2\pi} \left( \int_0^1 \sum_{m=-\infty}^{\infty} \sum_{l=-\infty}^{\infty} e^{2\pi ik(l-m)} u(x + 2\pi m) \bar{u}(x + 2\pi l) dk \right) dx$$

and since  $\int_0^1 e^{2\pi ik(l-m)} dk = \delta_{lm}$  (1 as  $l = m$  and 0 otherwise) it is equal to

$$\int_0^{2\pi} \sum_{m=-\infty}^{\infty} |u(x + 2\pi m)|^2 dx = \int_{-\infty}^{\infty} |u(x)|^2 dx.$$

So, we arrive to Plancherel theorem.

### Appendix 5.1.B. Discussion: pointwise convergence of Fourier integrals and series

Recall Theorem 4.4.4: Let  $f$  be a piecewise continuously differentiable function. Then the Fourier series

$$\frac{a_0}{2} + \sum_{n=1}^{\infty} \left( a_n \cos\left(\frac{\pi nx}{l}\right) + a_n \cos\left(\frac{\pi nx}{l}\right) \right) \quad (5.1.B.1)$$

converges to  $\frac{1}{2}(f(x+0) + f(x-0))$  if  $x$  is internal point and  $f$  is discontinuous at  $x$ .

Exactly the same statement holds for Fourier Integral in the real form

$$\int_0^{\infty} \left( A(k) \cos(kx) + B(k) \sin(kx) \right) dk \quad (5.1.B.2)$$

where  $A(k)$  and  $B(k)$  are cos- and sin-Fourier transforms.

None of them however holds for Fourier series or Fourier Integral in the complex form:

$$\sum_{n=-\infty}^{\infty} c_n e^{i \frac{\pi n x}{l}}, \quad (5.1.B.3)$$

$$\int_{-\infty}^{\infty} C(k) e^{ikx} dk. \quad (5.1.B.4)$$

Why and what remedy do we have? If we consider definition of the partial sum of (5.1.B.1) and then rewrite in the complex form and similar deal with (5.1.B.4) we see that in fact we should look at

$$\lim_{N \rightarrow \infty} \sum_{n=-N}^N c_n e^{i \frac{\pi n x}{l}}, \quad (5.1.B.5)$$

$$\lim_{N \rightarrow \infty} \int_{-N}^N C(k) e^{ikx} dk. \quad (5.1.B.6)$$

Meanwhile convergence in (5.1.B.3) and (5.1.B.4) means more than this:

$$\lim_{M, N \rightarrow \infty} \sum_{n=-M}^N c_n e^{i \frac{\pi n x}{l}}, \quad (5.1.B.7)$$

$$\lim_{M, N \rightarrow \infty} \int_{-M}^N C(k) e^{ikx} dk \quad (5.1.B.8)$$

where  $M, N$  tend to  $\infty$  independently. So the remedy is simple: understand convergence as in (5.1.B.5), (5.1.B.6) rather than as in (5.1.B.7), (5.1.B.8).

For integrals such limit is called **principal value** of integral and is denoted by

$$\text{pv} \int_{-\infty}^{\infty} G(k) dk.$$



Also similarly is defined the principal value of the integral, divergent in the finite point

$$\text{pv} \int_a^b G(k) dk := \lim_{\varepsilon \rightarrow +0} \left( \int_a^{c-\varepsilon} G(k) dk + \int_{c+\varepsilon}^b G(k) dk \right)$$

if there is a singularity at  $c \in (a, b)$ . Often instead of pv is used original (due to Cauchy) vp (valeur principale) and some other notations.

This is more general than the *improper integrals* studied in the end of Calculus I (which in turn generalize Riemann integrals). Those who took Complex Variables encountered such notion.

## 5.2 Properties of Fourier transform

### 5.2.1 Basic properties

In the previous Section 5.1 we introduced Fourier transform and Inverse Fourier transform

$$\hat{f}(k) = \frac{\kappa}{2\pi} \int_{-\infty}^{\infty} f(x) e^{-ikx} dx \quad (\text{FT})$$

$$\check{F}(x) = \frac{1}{\kappa} \int_{-\infty}^{\infty} F(k) e^{ikx} dk \quad (\text{IFT})$$

with  $\kappa = 1$  (but here we will be a bit more flexible):

**Theorem 5.2.1.**  $F = \hat{f} \iff f = \check{F}$ .

*Proof.* Already “proved” (formally). □

**Theorem 5.2.2.** (i) *Fourier transform:*  $f \mapsto \hat{f}$  is a linear operator  $L^2(\mathbb{R}, \mathbb{C}) \rightarrow L^2(\mathbb{R}, \mathbb{C})$ ;

(ii) *Inverse Fourier transform:*  $F \mapsto \check{F}$  is an inverse operator (and also a linear operator)  $L^2(\mathbb{R}, \mathbb{C}) \rightarrow L^2(\mathbb{R}, \mathbb{C})$ ;

(iii) If  $\kappa = \sqrt{2\pi}$  these operators are unitary i.e. preserve norm and an inner product:

$$\|f\| = \left( \int_{\mathbb{R}} |f(x)|^2 dx \right)^{\frac{1}{2}}, \quad (5.2.1)$$

$$(f, g) = \int_{\mathbb{R}} f(x) \bar{g}(x) dx. \quad (5.2.2)$$

*Proof.* Easy. Preservation of inner product follows from preservation of norm.  $\square$

*Remark 5.2.1.* (a) Here  $L^2(\mathbb{R}, \mathbb{C})$  is a space of square integrable complex-valued functions. Accurate definition requires a measure theory (studied in the course of Real Analysis). Alternatively one can introduce this space as a closure of the set of square integrable continuous functions but it also requires a certain knowledge of Real Analysis.

(b) Properties (i) and (ii) are obvious and (iii) is due to Plancherel's theorem.

(c) In Quantum Mechanics Fourier transform is sometimes referred to as "going to  $p$ -representation" (a.k.a. momentum representation) and Inverse Fourier transform is sometimes referred to as "going to  $q$ -representation" (a.k.a. coordinate representation). In this case  $\pm ikx$  is replaced by  $\pm i\hbar^{-1}kx$  and  $2\pi$  by  $2\pi\hbar$ .

**Theorem 5.2.3.** (i)  $g(x) = f(x - a) \implies \hat{g}(k) = e^{-ika} \hat{f}(k)$ ;

$$(ii) \quad g(x) = f(x)e^{ibx} \implies \hat{g}(k) = \hat{f}(k - b);$$

$$(iii) \quad g(x) = f'(x) \implies \hat{g}(k) = ik\hat{f}(k);$$

$$(iv) \quad g(x) = xf(x) \implies \hat{g}(k) = i\hat{f}'(k);$$

$$(v) \quad g(x) = f(\lambda x) \implies \hat{g}(k) = |\lambda|^{-1} \hat{f}(\lambda^{-1}k);$$

*Proof.* Here for brevity we do not write that all integrals are over  $\mathbb{R}$  and set  $\kappa = 2\pi$ .

$$(i) \quad \hat{g} = \int e^{-ikx} g(x) dx = \int e^{-ikx} f(x - a) dx = \int e^{-ik(x+a)} f(x) dx = e^{-ika} \hat{f}(k).$$

We replaced  $x$  by  $(x + a)$  in the integral.

$$(ii) \quad \hat{g} = \int e^{-ikx} g(x) dx = \int e^{-ikx} e^{ibx} f(x) dx = \int e^{-i(k-b)x} f(x) dx = \hat{f}(k - b).$$

$$(iii) \quad \hat{g} = \int e^{-ikx} g(x) dx = \int e^{-ikx} f'(x) dx \stackrel{\text{by parts}}{=} - \int (e^{-ikx})' f(x) dx = ik\hat{f}(k).$$

$$(iv) \quad \hat{g} = \int e^{-ikx} g(x) dx = \int e^{-ikx} xf(x) dx = \int i\partial_k(e^{-ikx}) f(x) dx = i\hat{f}'(k).$$

$$(v) \quad \hat{g} = \int e^{-ikx} g(x) dx = \int e^{-ikx} f(\lambda x) dx = \int e^{-ik\lambda^{-1}x} f(x) |\lambda|^{-1} dx = |\lambda|^{-1} \hat{f}(\lambda^{-1}k).$$

Here we replaced  $x$  by  $\lambda^{-1}x$  in the integral and  $|\lambda|^{-1}$  is an absolute value of Jacobian.

□

*Remark 5.2.2.* 1. Differentiating (i) by  $a$  and taking  $a = 0$  we get  $-\widehat{(f')}(k) = -ik\hat{f}(k)$  (another proof of (iii)).

2. Differentiating (ii) by  $b$  and taking  $b = 0$  we get  $i\widehat{(xf)}(k) = -\hat{f}'(k)$  (another proof of (iv)).

**Corollary 5.2.4.**  $f$  is even (odd) iff  $\hat{f}$  is even (odd).

## 5.2.2 Convolution

**Definition 5.2.1.** Convolution of functions  $f$  and  $g$  is a function  $f * g$ :

$$(f * g)(x) := \int f(x - y)g(y) dy. \quad (5.2.3)$$

**Theorem 5.2.5.** (i)  $h = f * g \implies \hat{h}(k) = \frac{2\pi}{\kappa} \hat{f}(k)\hat{g}(k)$ ;

(ii)  $h(x) = f(x)g(x) \implies \hat{h} = \kappa \hat{f} * \hat{g}$ ;

*Proof.* Again for brevity we do not write that all integrals are over  $\mathbb{R}$  and set  $\kappa = 2\pi$ .

(i) Obviously, for  $h = f * g$ , that is  $h(x) = \int f(x - y)g(y) dy$ ,

$$\hat{h}(k) = \frac{\kappa}{2\pi} \int e^{-ixk} h(x) dx = \frac{\kappa}{2\pi} \iint e^{-ixk} f(x - y)g(y) dx dy.$$

replacing in the integral  $x := y + z$  we arrive to

$$\frac{\kappa}{2\pi} \iint e^{-i(y+z)k} f(z)g(y) dz dy = \frac{\kappa}{2\pi} \int e^{-izk} f(z) dz \times \int e^{-iyk} g(y) dz$$

which is equal to  $\frac{2\pi}{\kappa} \hat{f}(k)\hat{g}(k)$ .

(ii) Similarly, using inverse Fourier transform we prove that  $\hat{f} * \hat{g}$  is a Fourier transform of  $\frac{\kappa_1}{2\pi} fg$  where  $\kappa_1 = \frac{2\pi}{\kappa}$

□

### 5.2.3 Examples

*Example 5.2.1.* (a) Let  $f(x) = \begin{cases} e^{-\alpha x} & x > 0, \\ 0 & x < 0. \end{cases}$  Here  $\operatorname{Re}(\alpha) > 0$ .

$$\hat{f}(k) = \int_0^{\infty} e^{-(\alpha+ik)x} dx = -\frac{\kappa}{2\pi(\alpha+ik)} e^{-(\alpha+ik)x} \Big|_{x=0}^{x=\infty} = \frac{\kappa}{2\pi(\alpha+ik)}.$$

(b) Correspondingly,  $f(x) = \begin{cases} e^{\alpha x} & x < 0, \\ 0 & x > 0 \end{cases} \implies \hat{f}(k) = \frac{\kappa}{2\pi(\alpha+ik)}.$

(c) Then  $f(x) = e^{-\alpha|x|} \implies \hat{f}(k) = \frac{\kappa\alpha}{\pi(\alpha^2+k^2)}.$

*Example 5.2.2.* Let  $f(x) = \frac{1}{\alpha^2+x^2}$  with  $\operatorname{Re}(\alpha) > 0$ . Then  $\hat{f}(k) = \kappa e^{-\alpha|k|}$ . Indeed, using Example 5.2.1(c) we conclude that  $f(x)$  is an inverse Fourier transform of  $\kappa e^{-\alpha|k|}$  since we need only to take into account different factors and replace  $i$  by  $-i$  (for even/odd functions the latter step could be replaced by multiplication by  $\pm 1$ ).

Using Complex Variables one can calculate it directly (residue should be calculated at  $-\alpha i \operatorname{sign}(k)$ ).

*Example 5.2.3.* Let  $f(x) = e^{-\frac{\alpha}{2}x^2}$  with  $\operatorname{Re}(\alpha) \geq 0$ . Here even for  $\operatorname{Re}(\alpha) = 0$  Fourier transform exists since integrals are converging albeit not absolutely.

Note that  $f' = -\alpha x f$ . Applying Fourier transform and Theorem 5.2.3 (iii), (iv) to the left and right expressions, we get  $ik\hat{f} = -i\alpha\hat{f}'$ ; solving it we arrive to  $\hat{f} = C e^{-\frac{1}{2\alpha}k^2}$ .

To find  $C$  note that  $C = \hat{f}(0) = \frac{\kappa}{2\pi} \int e^{-\frac{\alpha}{2}x^2} dx$  and for real  $\alpha > 0$  we make a change of variables  $x = \alpha^{-\frac{1}{2}}z$  and arrive to  $C = \frac{\kappa}{\sqrt{2\pi\alpha}}$  because  $\int e^{-z^2/2} dz = \sqrt{2\pi}$ . Therefore

$$\hat{f}(k) = \frac{\kappa}{\sqrt{2\pi\alpha}} e^{-\frac{1}{2\alpha}k^2}.$$

*Remark 5.2.3.* Knowing Complex Variables one can justify it for complex  $\alpha$  with  $\operatorname{Re}(\alpha) \geq 0$ ; we take a correct branch of  $\sqrt{\alpha}$  (condition  $\operatorname{Re}(\alpha) \geq 0$  prevents going around origin).

In particular,  $(\pm i)^{\frac{1}{2}} = e^{\pm \frac{i\pi}{4}} = \frac{1}{\sqrt{2}}(1 \pm i)$  and therefore for  $\alpha = \pm i\beta$  with for  $\beta > 0$  we get  $f = e^{\mp \frac{i\beta}{2}x^2}$  and

$$\hat{f}(k) = \frac{\kappa}{\sqrt{2\pi\beta}} e^{\pm \frac{\pi i}{4}} e^{\pm \frac{i}{2\beta}k^2} = \frac{\kappa}{2\sqrt{\pi\beta}} (1 \mp i) e^{\pm \frac{i}{2\beta}k^2}.$$

### 5.2.4 Poisson summation formula

**Theorem 5.2.6.** *Let  $f(x)$  be a continuous function on the line  $(-\infty, \infty)$  which vanishes for large  $|x|$ . Then for any  $a > 0$*

$$\sum_{n=-\infty}^{\infty} f(an) = \sum_{n=-\infty}^{\infty} \frac{2\pi}{a} \hat{f}\left(\frac{2\pi}{a}n\right). \quad (5.2.4)$$

*Proof.* Observe that function

$$g(x) = \sum_{n=-\infty}^{\infty} f(x + an)$$

is periodic with period  $a$ . Note that the Fourier coefficients of  $g(x)$  on the interval  $(-\frac{a}{2}, \frac{a}{2})$  are  $b_m = \frac{2\pi}{a} \hat{f}(\frac{2\pi}{a}m)$ , where  $\hat{f}(k)$  is the Fourier transform of  $f(x)$ .

Finally, in the Fourier series of  $g(x)$  on  $(-\frac{a}{2}, \frac{a}{2})$  plug  $x = 0$  to obtain  $g(0) = \sum_m b_m$  which coincides with (5.2.4).  $\square$

### 5.2.5 Final remarks

*Remark 5.2.4.* (a) Properties of Multidimensional Fourier transform and Fourier integral are discussed in Appendix 5.2.5.

(b) It is *very important* to do all problems from Problems to Sections 5.1 and 5.2: instead of calculating Fourier transforms directly you use Theorem 5.2.3 to expand the “library” of Fourier transforms obtained in Examples 5.2.1–5.2.3.

## Appendix 5.2.A. Multidimensional Fourier transform, Fourier integral

**Definition 5.2.A.1.** Multidimensional Fourier transform is defined as

$$\hat{f}(\mathbf{k}) = \left(\frac{\kappa}{2\pi}\right)^n \iiint_{\mathbb{R}^n} f(\mathbf{x}) e^{-i\mathbf{k}\cdot\mathbf{x}} d^n x \quad (\text{MFT})$$

$$\check{F}(\mathbf{x}) = \left(\frac{1}{\kappa}\right)^n \iiint_{\mathbb{R}^n} F(\mathbf{k}) e^{i\mathbf{k}\cdot\mathbf{x}} d^n \mathbf{k} \quad (\text{MIFT})$$

with  $\kappa = 1$  (but here we will be a bit more flexible).

All the main properties of 1-dimensional Fourier transform are preserved (with obvious modifications) but some less obvious modifications are mentioned:

*Remark 5.2.A.1.* Theorem 5.2.3(v) is replaced by

$$g(\mathbf{x}) = f(Q\mathbf{x}) \implies \hat{g}(\mathbf{k}) = |\det Q|^{-1} \hat{f}(Q^*{}^{-1}\mathbf{k}) \quad (5.2.A.1)$$

where  $Q$  is a non-degenerate linear transformation.

*Remark 5.2.A.2.* Example 5.2.2 is replaced by the following:

- (a) Let  $f(x) = e^{-\frac{1}{2}A\mathbf{x}\cdot\mathbf{x}}$  where  $A$  is a symmetric (but not necessarily real matrix)  $A^T = A$  with positive definite real part:

$$\operatorname{Re}(A\mathbf{x} \cdot \mathbf{x}) \geq \epsilon |\mathbf{x}|^2 \quad \forall \mathbf{x} \quad (5.2.A.2)$$

with  $\epsilon > 0$ . One can prove that inverse matrix  $A^{-1}$  has the same property and

$$\hat{f}(\mathbf{k}) = \left( \frac{\kappa}{\sqrt{2\pi}} \right)^n \det(A^{-\frac{1}{2}}) e^{-\frac{1}{2}A^{-1}\mathbf{k}\cdot\mathbf{k}}. \quad (5.2.A.3)$$

- (b) As long as a complex matrix  $A$  does not have eigenvalues on  $(-\infty, 0]$ , one can define properly  $A^z$ ,  $\log(A)$  etc.
- (c) In the case of Hermitian matrix  $A$  we have

$$\hat{f}(\mathbf{k}) = \left( \frac{\kappa}{\sqrt{2\pi}} \right)^n |\det A|^{-\frac{1}{2}} e^{-\frac{1}{2}A^{-1}\mathbf{k}\cdot\mathbf{k}}. \quad (5.2.A.4)$$

- (d) This could be generalized to the matrices satisfying condition

$$\operatorname{Re}(A\mathbf{x} \cdot \mathbf{x}) \geq 0 \quad \forall \mathbf{x}, \quad \det A \neq 0 \quad (5.2.A.5)$$

rather than (5.2.A.2). In particular, for anti-Hermitian matrix  $A = iB$  we have

$$\hat{f}(\mathbf{k}) = \left( \frac{\kappa}{\sqrt{2\pi}} \right)^n |\det B|^{-\frac{1}{2}} e^{-i\sigma(B)\pi/4} e^{i\frac{1}{2}B^{-1}\mathbf{k}\cdot\mathbf{k}}. \quad (5.2.A.6)$$

where  $\sigma(B) = \sigma_+(B) - \sigma_-(B)$ ,  $\sigma_{\pm}(B)$  is the number of positive (negative) eigenvalues of  $B$ .

*Remark 5.2.A.3.* Poisson summation formula Theorem 5.2.5 is replaced by

$$\sum_{\mathbf{m} \in \Gamma} f(\mathbf{m}) = \sum_{\mathbf{k} \in \Gamma^*} (2\pi)^n |\Omega|^{-1} \hat{f}(\mathbf{k}); \quad (5.2.A.7)$$

see Section 4.5.6.

*Example 5.2.A.4.* Find 3D-Fourier transform of  $u(\mathbf{x}) = f(|\mathbf{x}|)$  which is a spherically symmetric function in  $\mathbb{R}^3$ .

*Solution.* Due to Remark 5.2.A.1  $\hat{u}(\mathbf{k})$  is also spherically symmetric and therefore without any loss of the generality one can assume that  $\mathbf{k} = (0, 0, k)$  with  $k = |\mathbf{k}|$ . Then in the spherical coordinates

$$\begin{aligned} \hat{u}(0, 0, k) &= (2\pi)^{-3} \int_0^\infty d\rho \int_0^\pi d\varphi \int_0^{2\pi} e^{-ik\rho \cos(\varphi)} f(\rho) \rho^2 \sin(\varphi) d\theta \\ &= \frac{1}{4\pi^2 k i} \int_0^\infty e^{-ik\rho \cos(\varphi)} \Big|_{\varphi=0}^{\varphi=\pi} f(\rho) \rho d\rho \\ &= \frac{1}{2\pi^2 k} \int_0^\infty \sin(k\rho) f(\rho) \rho d\rho. \end{aligned}$$

Thus

$$\hat{u}(\mathbf{k}) = \frac{1}{2\pi^2} k^{-1} \int_0^\infty \sin(k\rho) f(\rho) \rho d\rho \quad \text{with } k = |\mathbf{k}|. \quad (5.2.A.8)$$

In particular, if  $f(\rho) = \begin{cases} 1 & \rho \leq 1, \\ 0 & \rho > 1, \end{cases}$  then  $\hat{u}(\mathbf{k}) = \frac{1}{2\pi^2 k^3} (\sin(k) - k \cos(k))$ . □

*Example 5.2.A.5.* Find 2D-Fourier transform of  $u(x, y) = \begin{cases} 1 & (x, y) \in D, \\ 0 & (x, y) \notin D \end{cases}$  where  $D$  is a triangle with the vertices  $(0, 0)$ ,  $(1, 0)$  and  $(0, 1)$ .

*Solution.*

$$\begin{aligned} \hat{u}(k, l) &= (2\pi)^{-2} \int_0^1 dx \int_0^{1-x} e^{-ixk - iyl} dy \\ &= \frac{i}{4\pi^2 l} \int_0^1 \left( e^{-ix(k-l) - il} - e^{-ixk} \right) dx = \frac{le^{-ik} - ke^{-il} + k - l}{4\pi^2 kl(k-l)}. \end{aligned}$$

□

## Appendix 5.2.B. Fourier transform in the complex domain

### Introduction

In this Appendix the familiarity with elements of the Complex Variables (like MAT334 at University of Toronto) is assumed.

When we can take in the definition

$$\hat{u}(z) = \frac{1}{2\pi} \int_{-\infty}^{\infty} u(x)e^{-ixz} dx \quad (5.2.B.1)$$

complex  $z$ ?

(a) Observe first that if

$$|u(x)| \leq C \begin{cases} e^{-ax} & x \leq 0, \\ e^{-bx} & x \geq 0, \end{cases} \quad (5.2.B.2)$$

with  $a < b$ , then integral (5.2.B.1) converges in the strip  $\{z: a < \text{Im}(z) < b\}$  and defines here a holomorphic function, which also tends to 0 as  $|z| \rightarrow \infty$ ,  $a + \epsilon \leq \text{Im}(z) \leq b - \epsilon$  with arbitrary  $\epsilon > 0$ .

(b) In particular, if

$$u(x) = 0 \quad \text{for } x \leq 0 \quad (5.2.B.3)$$

and satisfies (5.2.B.2), then integral (5.2.B.1) converges in the lower half-plane  $\{z: \text{Im}(z) < a\}$  and defines here a holomorphic function, which also tends to 0 as  $|z| \rightarrow \infty$ ,  $\text{Im}(z) \leq a - \epsilon$  with arbitrary  $\epsilon > 0$ .

(c) On the other hand, (almost) converse is also true due to Paley-Wiener theorem.

### Paley-Wiener Theorem

**Theorem 5.2.B.1** (Paley-Wiener theorem). *The following statements are equivalent:*

(i)  $f(z)$  is holomorphic in lower half-plane  $\{z: \text{Im}(z) > 0\}$ ,

$$\int_{-\infty}^{\infty} |f(\xi - i\eta)|^2 d\xi \leq M \quad \forall \eta \geq 0 \quad (5.2.B.4)$$



(ii) There exists a function  $u$ ,  $u(x) = 0$  for  $x < 0$  and

$$\int_{-\infty}^{\infty} |u(x)|^2 dx \leq M \quad (5.2.B.5)$$

such that  $f(z) = \hat{u}(z)$  for  $z: \operatorname{Im}(z) \leq 0$ .

*Remark 5.2.B.1.* To consider functions holomorphic in the lower half-plane  $\{z: \operatorname{Im}(z) < a\}$  one needs to apply Paley-Wiener theorem to  $g(z) = f(z - ia)$  with  $c < a$ .

To prove Paley-Wiener theorem one needs to consider Fourier integral

$$\begin{aligned} \hat{u}(z) = u(x) &:= \int_{-\infty}^{\infty} f(\xi) e^{ix\xi} d\xi \\ &= \int_{-\infty+i\eta}^{\infty+i\eta} f(z) e^{ixz} dz \end{aligned}$$

where we changed the contour of integration (and one can prove that the integral has not changed) observe, that for  $x < 0$  this integral tends to 0 as  $\eta \rightarrow +\infty$ .

## Laplace transform

Laplace transform is defined for functions  $u: [0, \infty) \rightarrow \mathbb{C}$  such that

$$|u(x)| \leq C e^{ax} \quad (5.2.B.6)$$

by

$$\mathcal{L}[u](p) = \int_0^{\infty} e^{-px} u(x) dx, \quad \operatorname{Re}(p) > a. \quad (5.2.B.7)$$

Obviously, it could be described this way: extend  $u(x)$  by 0 to  $(-\infty, 0)$ , then make a Fourier transform (5.2.B.1), and replace  $z = -ip$ ; then  $\operatorname{Im}(z) < a$  translates into  $\operatorname{Re}(p) > a$ .

Properties of Fourier transform translate into properties Laplace transform, but with a twist

$$(f * g)(x) := \int_0^x f(y)g(x-y) dy, \quad (5.2.B.8)$$

$$\mathcal{L}[u'](p) = p\mathcal{L}[u](p) - pu(0^+). \quad (5.2.B.9)$$

One can prove (5.2.B.9) by integration by parts. Those who are familiar with distributions (see Section 11.1) can obtain it directly because

$$(\mathcal{E}(u))'(x) = \mathcal{E}(u')(x) + u^+(0)\delta(x), \quad (5.2.B.10)$$

where  $\mathcal{E}$  is an operator of extension by 0 from  $[0, \infty)$  to  $(-\infty, \infty)$  and  $\delta$  is a Dirac delta function.

The Laplace transform provides a foundation to [Operational Calculus](#) by Oliver Heaviside. Its applications to Ordinary Differential Equations could be found in Chapter 6 of Boyce-DiPrima textbook.

### Using complex variables

Complex variables could be useful to find Fourier and inverse Fourier transforms of certain functions.

*Example 5.2.B.1.* Let us find Fourier transform of  $f(x) = \frac{1}{x^2 + a^2}$ ,  $\text{Re}(a) > 0$ .

$$\hat{f}(k) = \frac{1}{2\pi} \int_{-\infty}^{\infty} \frac{e^{-ikx} dx}{x^2 + a^2}.$$

As  $k \geq 0$  function  $\frac{e^{-ikz}}{z^2 + a^2}$  is holomorphic at  $\{z: \text{Im}(z) \leq 0\}$  except  $z = \mp ia$ , and nicely decays; then

$$\hat{f}(k) = \mp i \text{Res} \left( \frac{e^{-ikz}}{z^2 + a^2}; z = \mp ia \right) = \mp i \frac{e^{-ikz}}{2z} \Big|_{z=\pm ia} = \frac{1}{2} e^{-|k|a}.$$

One can apply the same arguments to any rational function  $\frac{P(x)}{Q(x)}$  where  $P(x)$  and  $Q(x)$  are polynomials of order  $m$  and  $n$ ,  $m < n$  and  $Q(x)$  does not have real roots.

### Appendix 5.2.C. Discrete Fourier transform

Sometimes decomposition into complex Fourier series is called discrete Fourier transform. Namely, consider  $L$ -periodic function (assuming for simplicity that it is sufficiently smooth)  $f(x)$ . Then it can be decomposed into Fourier

series, which, following Section 5.1 we write as

$$f(x) = \sum_{k_n} C(k_n) e^{k_n x} \Delta k_n, \quad (5.2.C.1)$$

$$C(k) := \frac{1}{2\pi} \int_I e^{-ik_n x} dx \quad (5.2.C.2)$$

with  $k_n = \frac{2\pi in}{L}$ ,  $h = \Delta k_k = \frac{2\pi}{L}$ . Now  $k$  is a discrete variable, running lattice (grid)  $K := \frac{2\pi}{L}\mathbb{Z}$ .

Let us call  $C(k)$  *discrete Fourier transform*.

Which properties of Fourier transform (see Section 5.2) hold for discrete Fourier transform, and which should be modified?

From Theorem 5.2.3 survive Statements (i), (ii) (with  $b \in K$  now, so periodicity does not break), (iii) and (v) (but only with  $\lambda \in \mathbb{Z}$ , so periodicity does not break).

Statement (iv) obviously does not, since multiplication by  $x$  breaks periodicity. Instead consider multiplications by  $\frac{1}{hi}(e^{ixh} - 1)$ ,  $\frac{1}{hi}(1 - e^{-ixh})$  and  $\frac{1}{h} \sin(xh)$ . These multiplications become *finite differences*

$$\begin{aligned} \Lambda_h^- \phi(k) &= \frac{1}{h} (\phi(k) - \phi(k - h)), \\ \Lambda_h^+ \phi(k) &= \frac{1}{h} (\phi(k + h) - \phi(k)), \\ \Lambda_h^- \phi(k) &= \frac{1}{2h} (\phi(k + h) - \phi(k - h)) \end{aligned}$$

while multiplication by  $\frac{2}{h^2}(\cos(xh) - 1)$  becomes a *discrete Laplacian*

$$\Delta_h \phi(k) = \frac{1}{h^2} (\phi(k + h) - 2\phi(k) + \phi(k - h)).$$

From Theorem 5.2.5 Statement (i) does not survive since convolution of periodic functions is not necessarily defined, but Statement (ii) survives with a *discrete convolution*

$$(f * g)(k) = \sum_{\omega \in K} f(\omega) g(k - \omega) h.$$

Those who are familiar with distributions (see Section 11.1) can observe that for  $L$ -periodic functions ordinary Fourier transform is

$$\hat{f}(\omega) = \sum_{k \in K} C(k) \delta(\omega - k) h$$

where  $\delta$  is a Dirac delta-function.

## Problems to Sections 5.1 and 5.2

Some of the problems could be solved based on the other problems and properties of Fourier transform (see Section 5.2) and such solutions are much shorter than from the scratch; seeing and exploiting connections is a plus.

*Problem 1.* Let  $F$  be an operator of Fourier transform:  $f(x) \rightarrow \hat{f}(k)$ . Prove that

- (a)  $F^*F = FF^* = I$ ;
- (b)  $(F^2f)(x) = f(-x)$  and therefore  $F^2f = f$  for even function  $f$  and  $F^2f = -f$  for odd function  $f$ ;
- (c)  $F^4 = I$ ;
- (d) If  $f$  is a real-valued function then  $\hat{f}$  is real-valued if and only if  $f$  is even and  $i\hat{f}$  is real-valued if and only if  $f$  is odd.

*Problem 2.* Let  $\alpha > 0$ . Find Fourier transforms of

- (a)  $f(x) = e^{-\alpha|x|}$ ;
- (b)  $f(x) = e^{-\alpha|x|} \cos(\beta x)$ ;
- (c)  $f(x) = e^{-\alpha|x|} \sin(\beta x)$ ;
- (d)  $f(x) = xe^{-\alpha|x|} \sin(\beta x)$ ;
- (e)  $f(x) = \begin{cases} e^{-\alpha x} & x > 0, \\ 0 & x \leq 0; \end{cases}$
- (f)  $f(x) = xe^{-\alpha|x|}$ ;
- (g)  $f(x) = xe^{-\alpha|x|} \cos(\beta x)$ ;
- (h)  $f(x) = x^2e^{-\alpha|x|}$ .
- (i)  $f(x) = \begin{cases} xe^{-\alpha x} & x > 0, \\ 0 & x \leq 0; \end{cases}$

*Problem 3.* Let  $\alpha > 0$ . Find Fourier transforms of

- (a)  $(x^2 + \alpha^2)^{-1}$ ;
- (b)  $x(x^2 + \alpha^2)^{-1}$ ;
- (c)  $(x^2 + \alpha^2)^{-1} \cos(\beta x)$ ;
- (d)  $(x^2 + \alpha^2)^{-1} \sin(\beta x)$ ;
- (e)  $x(x^2 + \alpha^2)^{-1} \cos(\beta x)$ ;
- (f)  $x(x^2 + \alpha^2)^{-1} \sin(\beta x)$ .

*Problem 4.* Let  $\alpha > 0$ . Based on Fourier transform of  $e^{-\alpha x^2/2}$  find Fourier transforms of

- (a)  $f(x) = xe^{-\alpha x^2/2}$ ;                      (d)  $e^{-\alpha x^2/2} \sin(\beta x)$ ;  
 (b)  $f(x) = x^2 e^{-\alpha x^2/2}$ ;                      (e)  $x e^{-\alpha x^2/2} \cos(\beta x)$ ,  
 (c)  $e^{-\alpha x^2/2} \cos(\beta x)$ ,                      (f)  $x e^{-\alpha x^2/2} \sin(\beta x)$ .

*Problem 5.* Find Fourier transforms of

Let  $a > 0$ . Find Fourier transforms  $\hat{f}(k)$  of functions

- (a)  $f(x) = \begin{cases} 1 & |x| \leq a, \\ 0 & |x| > a; \end{cases}$                       (d)  $f(x) = \begin{cases} a - |x| & |x| \leq a, \\ 0 & |x| > a; \end{cases}$   
 (b)  $f(x) = \begin{cases} x & |x| \leq a, \\ 0 & |x| > a; \end{cases}$                       (e)  $f(x) = \begin{cases} a^2 - x^2 & |x| \leq a, \\ 0 & |x| > a; \end{cases}$   
 (c)  $f(x) = \begin{cases} |x| & |x| \leq a, \\ 0 & |x| > a; \end{cases}$

- (f) Using (a) calculate  $\int_{-\infty}^{\infty} \frac{\sin(x)}{x} dx$ .

*Problem 6.* Using Complex Variables class (if you took one) find directly Fourier transforms  $\hat{f}(k)$  of functions

- (a)  $(x^2 + a^2)^{-1}$  with  $a > 0$ ;                      (d)  $x(x^2 + a^2)^{-2}$  with  $a > 0$ ;  
 (b)  $(x^2 + a^2)^{-1}(x^2 + b^2)^{-1}$ , with  $a > 0$ ,  $b > 0$ ,  $b \neq a$ ;                      (e)  $(x^2 + a^2)^{-1}(x^2 + b^2)^{-1}$ , with  $a > 0$ ,  $b > 0$ ,  $b \neq a$ ;  
 (c)  $(x^2 + a^2)^{-2}$  with  $a > 0$ ;                      (f)  $x(x^2 + a^2)^{-1}(x^2 + b^2)^{-1}$ , with  $a > 0$ ,  $b > 0$ ,  $b \neq a$ .

*Problem 7.* (a) Prove the same properties as in 1 for multidimensional Fourier transform (see Subsection 5.2.5).

- (b) Prove that if multidimensional function  $f$  has a rotational symmetry (that means  $f(Q\mathbf{x}) = f(\mathbf{x})$  for all orthogonal transform  $Q$ ) then  $\hat{f}$  also has a rotational symmetry (and conversely).

*Note.* Equivalently  $f$  has a rotational symmetry if  $f(\mathbf{x})$  depend only on  $|\mathbf{x}|$ .

*Problem 8.* Find multidimensional Fourier transforms of

$$\begin{aligned}
\text{(a)} \quad f(\mathbf{x}) &= \begin{cases} 1 & |\mathbf{x}| \leq a, \\ 0 & |\mathbf{x}| > a; \end{cases} & \text{(d)} \quad f(\mathbf{x}) &= \begin{cases} a^2 - |\mathbf{x}|^2 & |\mathbf{x}| \leq a, \\ 0 & |\mathbf{x}| > a. \end{cases} \\
\text{(b)} \quad f(\mathbf{x}) &= \begin{cases} a - |\mathbf{x}| & |\mathbf{x}| \leq a, \\ 0 & |\mathbf{x}| > a; \end{cases} & \text{(e)} \quad f(x) &= e^{-\alpha|x|}; \\
\text{(c)} \quad f(\mathbf{x}) &= \begin{cases} (a - |\mathbf{x}|)^2 & |\mathbf{x}| \leq a, \\ 0 & |\mathbf{x}| > a; \end{cases} & \text{(f)} \quad f(\mathbf{x}) &= |\mathbf{x}|e^{-\alpha|\mathbf{x}|}; \\
& & \text{(g)} \quad f(\mathbf{x}) &= |\mathbf{x}|^2e^{-\alpha|\mathbf{x}|}.
\end{aligned}$$

*Hint.* Using Problem 7(b) observe that we need to find only  $\hat{f}(0, \dots, 0, k)$  and use appropriate coordinate system (polar as  $n = 2$ , or spherical as  $n = 3$  and so one).

*Note.* This problem could be solved as  $n = 2$ ,  $n = 3$  or  $n \geq 2$  (any).

## 5.3 Applications of Fourier transform to PDEs

### 5.3.1 Heat Equation

Consider problem

$$u_t = ku_{xx}, \quad t > 0, \quad -\infty < x < \infty, \quad (5.3.1)$$

$$u|_{t=0} = g(x). \quad (5.3.2)$$

Making partial Fourier transform with respect to  $x \mapsto \xi$  (so  $u(x, t) \mapsto \hat{u}(\xi, t)$ ) we arrive to

$$\hat{u}_t = -k\xi^2\hat{u}, \quad (5.3.3)$$

$$\hat{u}|_{t=0} = \hat{g}(\xi). \quad (5.3.4)$$

Indeed,  $\partial_x \mapsto i\xi$  and therefore  $\partial_x^2 \mapsto -\xi^2$ .

Note that (5.3.3) (which is  $\hat{u}_t = -k\xi^2\hat{u}$ ) is an ODE and solving it we arrive to  $\hat{u} = A(\xi)e^{-k\xi^2t}$ ; plugging into (5.3.4) (which is  $\hat{u}|_{t=0} = \hat{g}(\xi)$ ) we find that  $A(\xi) = \hat{g}(\xi)$  and therefore

$$\hat{u}(\xi, t) = \hat{g}(\xi)e^{-k\xi^2t}. \quad (5.3.5)$$

The right-hand expression is a product of two Fourier transforms, one is  $\hat{g}(\xi)$  and another is Fourier transform of IFT of  $e^{-k\xi^2 t}$  (reverse engineering?).

If we had  $e^{-\xi^2/2}$  we would have IFT equal to  $\sqrt{2\pi}e^{-x^2/2}$ ; but we can get from  $e^{-\xi^2/2}$  to  $e^{-k\xi^2 t}$  by scaling  $\xi \mapsto (2kt)^{\frac{1}{2}}\xi$  and therefore  $x \mapsto (2kt)^{-\frac{1}{2}}x$  (and we need to multiply the result by  $(2kt)^{-\frac{1}{2}}$ );

therefore  $e^{-k\xi^2 t}$  is a Fourier transform of  $\frac{\sqrt{2\pi}}{\sqrt{2kt}}e^{-x^2/4kt}$ .

Again:  $\hat{u}(\xi, t)$  is a product of FT of  $g$  and of  $\frac{\sqrt{2\pi}}{\sqrt{2kt}}e^{-x^2/4kt}$  and therefore  $u$  is the convolution of these functions (multiplied by  $1/(2\pi)$ ):

$$u(x, t) = g * \frac{1}{\sqrt{4\pi kt}}e^{-\frac{x^2}{4kt}} = \frac{1}{\sqrt{4\pi kt}} \int_{-\infty}^{\infty} g(x')e^{-\frac{(x-x')^2}{4kt}} dx'. \quad (5.3.6)$$

We recovered formula which we had already.

*Remark 5.3.1.* Formula (5.3.5) shows that the problem is really ill-posed for  $t < 0$ .

### 5.3.2 Schrödinger equation

Consider problem

$$u_t = ik u_{xx}, \quad t > 0, \quad -\infty < x < \infty, \quad (5.3.7)$$

$$u|_{t=0} = g(x). \quad (5.3.8)$$

Making partial Fourier transform with respect to  $x \mapsto \xi$  (so  $u(x, t) \mapsto \hat{u}(\xi, t)$ ) we arrive to

$$\hat{u}_t = -ik\xi^2 \hat{u}, \quad (5.3.9)$$

$$\hat{u}|_{t=0} = \hat{g}(\xi). \quad (5.3.10)$$

Note that (5.3.9) is an ODE and solving it we arrive to  $\hat{u} = A(\xi)e^{-ik\xi^2 t}$ ; plugging into (5.3.10) we find that  $A(\xi) = \hat{g}(\xi)$  and therefore

$$\hat{u}(\xi, t) = \hat{g}(\xi)e^{-ik\xi^2 t}. \quad (5.3.11)$$

The right-hand expression is a product of two Fourier transforms, one is  $\hat{g}(\xi)$  and another is Fourier transform of IFT of  $e^{-ik\xi^2 t}$  (reverse engineering?).

As it was explained in Section 5.2 that we need just to plug  $ik$  instead of  $k$  (as  $t > 0$ ) into the formulae we got before; so instead of  $\frac{1}{\sqrt{4\pi kt}}e^{-\frac{x^2}{4kt}}$  we

get  $\frac{1}{\sqrt{4\pi kit}} e^{\frac{x^2}{4kit}} = \frac{1}{\sqrt{4\pi kt}} e^{-\frac{\pi i}{4} + \frac{ix^2}{4kt}}$  because we need to take a correct branch of  $\sqrt{i} = e^{\frac{i\pi}{4}}$ .

As  $t < 0$  we need to replace  $t$  by  $-t$  and  $i$  by  $-i$  resulting in  $\frac{1}{\sqrt{4\pi k|t|}} e^{\frac{\pi i}{4} + \frac{ix^2}{4kt}}$ .

Therefore

$$u(x, t) = \frac{1}{\sqrt{4\pi k|t|}} \int_{-\infty}^{\infty} g(x') e^{\mp \frac{i\pi}{4} + \frac{i(x-x')^2}{4kt}} dx' \quad (5.3.12)$$

as  $\pm t > 0$ .

*Remark 5.3.2.* Formula (5.3.11) shows that the problem is well-posed for both  $t > 0$  and  $t < 0$ .

### 5.3.3 Laplace equation in half-plane

Consider problem

$$\Delta u := u_{xx} + u_{yy} = 0, \quad y > 0, \quad -\infty < x < \infty, \quad (5.3.13)$$

$$u|_{y=0} = g(x). \quad (5.3.14)$$

*Remark 5.3.3.* This problem definitely is not uniquely solvable (f.e.  $u = y$  satisfies homogeneous boundary condition) and to make it uniquely solvable we need to add condition  $|u| \leq M$ .

Making partial Fourier transform with respect to  $x \mapsto \xi$  (so  $u(x, t) \mapsto \hat{u}(\xi, t)$ ) we arrive to

$$\hat{u}_{yy} - \xi^2 \hat{u} = 0, \quad (5.3.15)$$

$$\hat{u}|_{y=0} = \hat{g}(\xi). \quad (5.3.16)$$

Note that (5.3.15) (which is  $\hat{u}_{yy} - \xi^2 \hat{u} = 0$ ) is an ODE and solving it we arrive to

$$\hat{u}(\xi, y) = A(\xi) e^{-|\xi|y} + B(\xi) e^{|\xi|y}. \quad (5.3.17)$$

Indeed, characteristic equation  $\alpha^2 - \xi^2$  has two roots  $\alpha_{1,2} = \pm|\xi|$ ; we take  $\pm|\xi|$  instead of just  $\pm\xi$  because we need to control signs.

We discard the second term in the right-hand expression of (5.3.17) because it is unbounded. However if we had Cauchy problem (i.e.  $u|_{y=0} = g(x)$ ,  $u_y|_{y=0} = h(x)$ ) we would not be able to do this and this problem will be ill-posed.



So,  $\hat{u} = A(\xi)e^{-|\xi|y}$  and (5.3.16) yields  $A(\xi) = \hat{g}(\xi)$ :

$$\hat{u}(\xi, y) = \hat{g}(\xi)e^{-|\xi|y}. \quad (5.3.18)$$

Now we need to find the IFT of  $e^{-|\xi|y}$ . This calculations are easy (do them!) and IFT is  $2y(x^2 + y^2)^{-1}$ . Then

$$u(x, y) = \frac{1}{\pi} \int_{-\infty}^{\infty} g(x') \frac{y}{(x - x')^2 + y^2} dx'. \quad (5.3.19)$$

*Remark 5.3.4.* Setting  $y = 0$  we see that  $u|_{y=0} = 0$ . Contradiction?—No, we cannot just set  $y = 0$ . We need to find a limit as  $y \rightarrow +0$ , and note that  $\frac{y}{(x - x')^2 + y^2} \rightarrow 0$  except as  $x' = x$  and

$$\frac{1}{\pi} \int_{-\infty}^{\infty} \frac{y}{(x - x')^2 + y^2} dx' = 1$$

so the limit will be  $g(x)$  as it should be.

### 5.3.4 Laplace equation in half-plane. II

Replace Dirichlet boundary condition by Robin boundary condition

$$\Delta u := u_{xx} + u_{yy} = 0, \quad y > 0, \quad -\infty < x < \infty, \quad (5.3.13)$$

$$(u_y - \alpha u)|_{y=0} = h(x). \quad (5.3.20)$$

Then (5.3.16) (which is  $\hat{u}|_{y=0} = \hat{g}(\xi)$ ) should be replaced by

$$(\hat{u}_y - \alpha \hat{u})|_{y=0} = \hat{h}(\xi). \quad (5.3.21)$$

and then

$$A(\xi) = -(|\xi| + \alpha)^{-1} \hat{h}(\xi) \quad (5.3.22)$$

and

$$\hat{u}(\xi, y) = -\hat{h}(\xi)(|\xi| + \alpha)^{-1} e^{-|\xi|y}. \quad (5.3.23)$$

The right-hand expression is a nice function provided  $\alpha > 0$  (and this is correct from the physical point of view) and therefore everything is fine (but we just cannot calculate explicitly IFT of  $(|\xi| + \alpha)^{-1} e^{-|\xi|y}$ ).

Consider Neumann boundary condition i.e. set  $\alpha = 0$ . Then we have a trouble:  $-\hat{h}(\xi)(|\xi| + \alpha)^{-1}e^{-|\xi|y}$  could be singular at  $\xi = 0$  and to avoid it we assume that  $\hat{h}(0) = 0$ . This means exactly that

$$\int_{-\infty}^{\infty} h(x) dx = 0 \quad (5.3.24)$$

and this condition we really need and it is justified from the physical point of view: f.e. if we are looking for stationary heat distribution and we have heat flow defined, we need to assume that the total flow is 0 (otherwise there will be no stationary distribution!).

So we need to calculate IFT of  $-|\xi|^{-1}e^{-|\xi|y}$ . Note that derivative of this with respect to  $y$  is  $e^{-|\xi|y}$  which has an IFT  $\frac{y}{\pi(x^2 + y^2)}$ ; integrating with respect to  $y$  we get  $\frac{1}{2\pi} \log(x^2 + y^2) + c$  and therefore

$$u(x, y) = \frac{1}{2\pi} \int_{-\infty}^{\infty} h(x') \log((x - x')^2 + y^2) dx' + C. \quad (5.3.25)$$

*Remark 5.3.5.* (a) Here  $C$  is an arbitrary constant. Again, the same physical interpretation: knowing heat flow we define solution up to a constant as the total heat energy is arbitrary.

(b) Formula (5.3.25) gives us a solution which can grow as  $|x| \rightarrow \infty$  even if  $h$  is fast decaying there (or even if  $h(x) = 0$  as  $|x| \geq c$ ).

However as  $|x| \gg 1$  and  $h$  is fast decaying  $((x - x')^2 + y^2) \approx (x^2 + y^2)$  (with a small error) and growing part of  $u$  is  $\frac{1}{2\pi} \log(x^2 + y^2) \int_{-\infty}^{\infty} h(x') dx'$  which is 0 precisely because of condition (5.3.24):  $\int_{-\infty}^{\infty} h(x') dx' = 0$ .

### 5.3.5 Laplace equation in strip

Consider problem

$$\Delta u := u_{xx} + u_{yy} = 0, \quad 0 < y < b, \quad -\infty < x < \infty, \quad (5.3.26)$$

$$u|_{y=0} = g(x), \quad (5.3.27)$$

$$u|_{y=b} = h(x). \quad (5.3.28)$$

Then we get (5.3.17) again

$$\hat{u}(\xi, y) = A(\xi)e^{-|\xi|y} + B(\xi)e^{|\xi|y} \quad (5.3.17)$$

but with two boundary condition we cannot discard anything; we get instead

$$A(\xi) + B(\xi) = \hat{g}(\xi), \quad (5.3.29)$$

$$A(\xi)e^{-|\xi|b} + B(\xi)e^{|\xi|b} = \hat{h}(\xi) \quad (5.3.30)$$

which implies

$$\begin{aligned} A(\xi) &= \frac{e^{|\xi|b}}{2 \sinh(|\xi|b)} \hat{g}(\xi) - \frac{1}{2 \sinh(|\xi|b)} \hat{h}(\xi), \\ B(\xi) &= -\frac{e^{-|\xi|b}}{2 \sinh(|\xi|b)} \hat{g}(\xi) + \frac{1}{2 \sinh(|\xi|b)} \hat{h}(\xi) \end{aligned}$$

and therefore

$$\hat{u}(\xi, y) = \frac{\sinh(|\xi|(b-y))}{\sinh(|\xi|b)} \hat{g}(\xi) + \frac{\sinh(|\xi|y)}{\sinh(|\xi|b)} \hat{h}(\xi). \quad (5.3.31)$$

One can see easily that  $\frac{\sinh(|\xi|(b-y))}{\sinh(|\xi|b)}$  and  $\frac{\sinh(|\xi|y)}{\sinh(|\xi|b)}$  are bounded for  $0 \leq y \leq b$  and fast decaying as  $|\xi| \rightarrow \infty$  for  $y \geq \epsilon$  (for  $y \leq b - \epsilon$  respectively) with arbitrarily small  $\epsilon > 0$ .

*Problem 5.3.1.* Investigate other boundary conditions (Robin, Neumann, mixed-Dirichlet at  $y = 0$  and Neumann at  $y = b$  and so on.).

### 5.3.6 1D Wave equation

Consider problem

$$u_{tt} = c^2 u_{xx}, \quad -\infty < x < \infty, \quad (5.3.32)$$

$$u|_{t=0} = g(x), \quad (5.3.33)$$

$$u_t|_{t=0} = h(x). \quad (5.3.34)$$

Making partial Fourier transform with respect to  $x \mapsto \xi$  we arrive to

$$\hat{u}_{tt} = -c^2 \xi^2 \hat{u}_{xx}, \quad (5.3.35)$$

$$\hat{u}|_{t=0} = \hat{g}(\xi), \quad (5.3.36)$$

$$\hat{u}_t|_{t=0} = \hat{h}(\xi). \quad (5.3.37)$$

Then characteristic equation for ODE (5.3.35) (which is  $\hat{u}_{tt} = -c^2\xi^2\hat{u}_{xx}$ ) is  $\alpha^2 = -c^2\xi^2$  and  $\alpha_{1,2} = \pm ic\xi$ ,

$$\hat{u}(\xi, t) = A(\xi) \cos(c\xi t) + B(\xi) \sin(c\xi t)$$

with initial conditions implying  $A(\xi) = \hat{g}(\xi)$ ,  $B(\xi) = 1/(ci\xi) \cdot \hat{h}(\xi)$  and

$$\hat{u}(\xi, t) = \hat{g}(\xi) \cos(c\xi t) + \hat{h}(\xi) \cdot \frac{1}{c\xi} \sin(c\xi t). \quad (5.3.38)$$

Rewriting  $\cos(c\xi t) = \frac{1}{2}(e^{ic\xi t} + e^{-ic\xi t})$  and recalling that multiplication of FT by  $e^{i\xi b}$  is equivalent to the shifting original to the left by  $b$  we conclude that  $\hat{g}(\xi) \cos(c\xi t)$  is a Fourier transform of  $\frac{1}{2}(g(x+ct) + g(x-ct))$ .

If we denote  $H$  as a primitive of  $h$  then  $\hat{h}(\xi) \cdot \frac{1}{c\xi} \sin(c\xi t) = \hat{H}(\xi) \cdot \frac{1}{c} i \sin(c\xi t)$  which in virtue of the same arguments is FT of  $\frac{1}{2c}(H(x+ct) - H(x-ct)) = \frac{1}{2c} \int_{x-ct}^{x+ct} h(x') dx'$ .

Therefore

$$u(x, t) = \frac{1}{2}(g(x+ct) + g(x-ct)) + \frac{1}{2c} \int_{x-ct}^{x+ct} h(x') dx' \quad (5.3.39)$$

and we arrive again to D'Alembert formula.

### 5.3.7 Airy equation

Airy equation is 2-nd order ODE

$$y'' - xy = 0$$

which plays an important role in the theory of electromagnetic wave propagation (toy-model for caustics and convex-obstacle diffraction). Making Fourier transform we arrive to

$$-\xi^2 \hat{y} + i\hat{y}' = 0$$

which implies

$$\hat{y} = C e^{\frac{1}{3}i\xi^3} \implies y(x) = C \int_{-\infty}^{\infty} e^{\frac{1}{3}i\xi^3 + ix\xi} d\xi.$$

This is *Airy function* (when studying it, Complex Variables are very handy).

One can ask, why we got only one linearly independent solution? 2-nd order ODE must have 2. The second solution, however, grows really fast (superexponentially) as  $x \rightarrow +\infty$  and is cut-off by Fourier transform.

### 5.3.8 Multidimensional equations

Multidimensional equations are treated in the same way:

**Heat and Schrödinger equations.** We make partial FT (with respect to spatial variables) and we get

$$\begin{aligned}\hat{u}(\boldsymbol{\xi}, t) &= \hat{g}(\boldsymbol{\xi})e^{-k|\boldsymbol{\xi}|^2t}, \\ \hat{u}(\boldsymbol{\xi}, t) &= \hat{g}(\boldsymbol{\xi})e^{-ik|\boldsymbol{\xi}|^2t}\end{aligned}$$

respectively where  $\boldsymbol{\xi} = (\xi_1, \dots, \xi_n)$ ,  $|\boldsymbol{\xi}| = (\xi_1^2 + \dots + \xi_n^2)^{\frac{1}{2}}$ ; in this case  $e^{-k|\boldsymbol{\xi}|^2t} = \prod_{j=1}^n e^{-k|\xi_j|^2t}$  is a product of functions depending on different variables, so IFT will be again such product and we have IFT equal

$$\prod_{j=1}^n \frac{1}{\sqrt{4\pi kt}} e^{-|x_j|^2/4kt} = (4\pi kt)^{-\frac{n}{2}} e^{-|\boldsymbol{x}|^2/4kt}$$

for heat equation and similarly for Schrödinger equation and we get a solution as a multidimensional convolution. Here  $\boldsymbol{x} = (x_1, \dots, x_n)$  and  $|\boldsymbol{x}| = (x_1^2 + \dots + x_n^2)^{\frac{1}{2}}$ .

**Wave equation.** We do the same but now

$$\hat{u}(\boldsymbol{\xi}, t) = \hat{g}(\boldsymbol{\xi}) \cos(c|\boldsymbol{\xi}|t) + \hat{h}(\boldsymbol{\xi}) \cdot \frac{1}{c|\boldsymbol{\xi}|} \sin(c|\boldsymbol{\xi}|t).$$

Finding IFT is not easy. We will do it (kind of) for  $n = 3$  in Section 9.1.

**Laplace equation.** We consider it in  $\mathbb{R}^n \times I \ni (\boldsymbol{x}; y)$  with either  $I = \{y : y > 0\}$  or  $I = \{y : 0 < y < b\}$  and again make partial FT with respect to  $\boldsymbol{x}$  but not  $y$ .

### Problems to Section 5.3

*Problem 1.* (a) Consider Dirichlet problem

$$\begin{aligned}u_{xx} + u_{yy} &= 0, & -\infty < x < \infty, y > 0, \\ u|_{y=0} &= f(x).\end{aligned}$$

Make Fourier transform by  $x$ , solve problem for ODE for  $\hat{u}(k, y)$  which you get as a result and write  $u(x, y)$  as a Fourier integral.

(b) Consider Neumann problem

$$\begin{aligned} u_{xx} + u_{yy} &= 0, & -\infty < x < \infty, y > 0, \\ u_y|_{y=0} &= f(x). \end{aligned}$$

Make Fourier transform by  $x$ , solve problem for ODE for  $\hat{u}(k, y)$  which you get as a result and write  $u(x, y)$  as a Fourier integral. What condition must satisfy  $f$ ?

*Problem 2.* (a) Consider Dirichlet problem

$$\begin{aligned} u_{xx} + u_{yy} &= 0, & -\infty < x < \infty, 0 < y < 1, \\ u|_{y=0} &= f(x), & u|_{y=1} = g(x). \end{aligned}$$

Make Fourier transform by  $x$ , solve problem for ODE for  $\hat{u}(k, y)$  which you get as a result and write  $u(x, y)$  as a Fourier integral.

(b) Consider Dirichlet-Neumann problem

$$\begin{aligned} u_{xx} + u_{yy} &= 0, & -\infty < x < \infty, 0 < y < 1, \\ u|_{y=0} &= f(x), & u_y|_{y=1} = g(x). \end{aligned}$$

Make Fourier transform by  $x$ , solve problem for ODE for  $\hat{u}(k, y)$  which you get as a result and write  $u(x, y)$  as a Fourier integral.

(c) Consider Neumann problem

$$\begin{aligned} u_{xx} + u_{yy} &= 0, & -\infty < x < \infty, 0 < y < 1, \\ u_y|_{y=0} &= f(x), & u_y|_{y=1} = g(x). \end{aligned}$$

Make Fourier transform by  $x$ , solve problem for ODE for  $\hat{u}(k, y)$  which you get as a result and write  $u(x, y)$  as a Fourier integral. What condition must satisfy  $f, g$ ?

*Problem 3.* Consider Robin problem

$$\begin{aligned} u_{xx} + u_{yy} &= 0, & -\infty < x < \infty, y > 0, \\ (u_y + \alpha u)|_{y=0} &= f(x). \end{aligned}$$

Make Fourier transform by  $x$ , solve problem for ODE for  $\hat{u}(k, y)$  which you get as a result and write  $u(x, y)$  as a Fourier integral. What condition (if any) must satisfy  $f$ ?

*Hint.* Consider separately cases

(A)  $\alpha \in \mathbb{C} \setminus [0, \infty)$  and

(B)  $\alpha \in [0, \infty)$ .

*Problem 4.* (a) Consider problem

$$\begin{aligned} \Delta^2 = 0, & \quad -\infty < x < \infty, y > 0, \\ u|_{y=0} = f(x), & \quad u_y|_{y=0} = g(x). \end{aligned}$$

Make Fourier transform by  $x$ , solve problem for ODE for  $\hat{u}(k, y)$  which you get as a result and write  $u(x, y)$  as a Fourier integral.

(b) Consider problem

$$\begin{aligned} \Delta^2 = 0, & \quad -\infty < x < \infty, y > 0, \\ u_{yy}|_{y=0} = f(x), & \quad \Delta u_y|_{y=0} = g(x). \end{aligned}$$

Make Fourier transform by  $x$ , solve problem for ODE for  $\hat{u}(k, y)$  which you get as a result and write  $u(x, y)$  as a Fourier integral. What condition must satisfy  $f, g$ ?

*Problem 5.* In the problems below solution  $u(x, t)$ , must be represented in the form of the appropriate Fourier integral:

$$(a) \begin{cases} u_{tt} = -4u_{xxxx} & -\infty < x < \infty, -\infty < t < \infty, \\ u|_{t=0} = \begin{cases} 1 & |x| < 2, \\ 0 & |x| \geq 2, \end{cases} & u_t|_{t=0} = 0, \\ \max |u| < \infty. \end{cases}$$

$$(b) \begin{cases} u_t = 4u_{xx} & -\infty < x < \infty, t > 0, \\ u|_{t=0} = e^{-|x|} \\ \max |u| < \infty. \end{cases}$$

$$(c) \begin{cases} u_t = u_{xx} & -\infty < x < \infty, t > 0, \\ u|_{t=0} = \begin{cases} 1 - x^2 & |x| < 1, \\ 0 & |x| \geq 1, \end{cases} \\ \max |u| < \infty. \end{cases}$$

$$(d) \begin{cases} u_{tt} = u_{xx} - 4u & -\infty < x < \infty, \\ u|_{t=0} = 0, & u_t|_{t=0} = e^{-x^2/2}. \end{cases}$$

*Problem 6.* In the half-plane  $\{(x, y) : x > 0, -\infty < y < \infty\}$  find solution

$$\begin{aligned} \Delta u &= 0, \\ u|_{x=0} &= e^{-|y|}, \\ \max |u| &< \infty. \end{aligned}$$

Solution should be represented in the form of the appropriate Fourier integral.

*Problem 7.* In the strip  $\{(x, y) : 0 < x < 1, -\infty < y < \infty\}$  find solution

$$\begin{aligned} \Delta u - u &= 0, \\ u_x|_{x=0} &= 0, \\ u|_{x=1} &= \begin{cases} \cos(y) & |y| \leq \frac{\pi}{2}, \\ 0 & |y| \geq \frac{\pi}{2}, \end{cases} \\ \max |u| &< \infty. \end{aligned}$$

Solution should be represented in the form of the appropriate Fourier integral.

*Problem 8.* In the strip  $\{(x, y) : 0 < x < 1, -\infty < y < \infty\}$  find solution

$$\begin{aligned} \Delta u - 4u &= 0, \\ u_x|_{x=0} &= 0, \\ u_x|_{x=1} &= \begin{cases} 1 - |y| & |y| \leq 1, \\ 0 & |y| \geq 1, \end{cases} \\ \max |u| &< \infty. \end{aligned}$$

Solution should be represented in the form of the appropriate Fourier integral.

*Problem 9.* In the strip  $\{(x, y) : 0 < x < 1, -\infty < y < \infty\}$  find solution

$$\begin{aligned} \Delta u &= 0, \\ u|_{x=0} &= 0, \\ u|_{x=1} &= \begin{cases} 1 - y^2 & |y| \leq 1, \\ 0 & |y| \geq 1, \end{cases} \\ \max |u| &< \infty. \end{aligned}$$

Solution should be represented in the form of the appropriate Fourier integral.



*Problem 10.* Solve the following equations explicitly for  $u(x)$  (that means do *not* leave your answer in integral form!).

$$(a) \quad e^{-\frac{x^2}{2}} = \frac{1}{2} \int_{-\infty}^{\infty} e^{-|x-y|} u(y) dy;$$

$$(b) \quad e^{-x^2} = \int_0^{\infty} f(x-y) e^{-y} dy;$$

$$(c) \quad e^{-\frac{x^2}{4}} = \int_{-\infty}^0 u(x-y) e^{\frac{1}{2}y} dy;$$

$$(d) \quad e^{-\frac{x^2}{2}} = \frac{1}{\sqrt{6\pi}} \int_{-\infty}^{\infty} e^{-2(x-y)^2} u(y) dy;$$

$$(e) \quad \frac{1}{4+x^2} = \int_{-\infty}^{\infty} \frac{u(x-y)}{y^2+1} dy;$$

$$(f) \quad e^{-|x|} = \int_1^{\infty} e^{-y} u(x-y) dy;$$

$$(g) \quad e^{-|x|} = \int_x^{\infty} e^{-2(y-x)} u(y) dy;$$

$$(h) \quad xe^{-|x|} = \int_{-\infty}^{\infty} e^{-|x-y|} u(y) dy.$$

# Chapter 6

## Separation of variables

In this Chapter we continue study separation of variables which we started in Chapter 4 but interrupted to explore Fourier series and Fourier transform.

### 6.1 Separation of variables for heat equation

#### 6.1.1 Dirichlet boundary conditions

Consider problem

$$u_t = ku_{xx} \qquad 0 < x < l, \quad t > 0, \qquad (6.1.1)$$

$$u|_{x=0} = u|_{x=l} = 0, \qquad (6.1.2)$$

$$u|_{t=0} = g(x). \qquad (6.1.3)$$

Let us consider a *simple solution*  $u(x, t) = X(x)T(t)$ ; then, separating variables, we arrive to  $\frac{T'}{T} = k\frac{X''}{X}$  which implies  $X'' + \lambda X = 0$  and

$$T' = -k\lambda T \qquad (6.1.4)$$

(explain, how). We also get boundary conditions  $X(0) = X(l) = 0$  (explain, how).

So, we have eigenvalues  $\lambda_n = (\frac{\pi n}{l})^2$  and eigenfunctions  $X_n = \sin(\frac{\pi n x}{l})$  ( $n = 1, 2, \dots$ ) and also equation (6.1.4) ( $T' = -k\lambda T$ ) for  $T$ , which results in

$$T_n = A_n e^{-k\lambda_n t} \qquad (6.1.5)$$

and therefore a simple solution is

$$u_n = A_n e^{-k\lambda_n t} \sin\left(\frac{\pi n x}{l}\right) \quad (6.1.6)$$

and we look for a general solution in the form

$$u = \sum_{n=1}^{\infty} A_n e^{-k\lambda_n t} \sin\left(\frac{\pi n x}{l}\right). \quad (6.1.7)$$

Again, taking in account initial condition (6.1.3) ( $u|_{t=0} = g(x)$ ) we see that

$$\sum_{n=1}^{\infty} A_n \sin\left(\frac{\pi n x}{l}\right) = g(x). \quad (6.1.8)$$

and therefore

$$A_n = \frac{2}{l} \int_0^l g(x) \sin\left(\frac{\pi n x}{l}\right) dx. \quad (6.1.9)$$

### 6.1.2 Corollaries

(a) Formula (6.1.6) shows that the problem is really ill-posed for  $t < 0$ .

(b) Formula (6.1.7) shows that as  $t \rightarrow +\infty$

$$u = O(e^{-k\lambda_1 t}); \quad (6.1.10)$$

(c) Moreover, we have as  $t \rightarrow +\infty$

$$u = A_1 e^{-k\lambda_1 t} X_1(x) e^{-k\lambda_1 t} + O(e^{-k\lambda_2 t}). \quad (6.1.11)$$

Consider now *inhomogeneous problem with the right-hand expression and boundary conditions independent on  $t$* :

$$u_t = k u_{xx} + f(x), \quad t > 0, \quad 0 < x < l, \quad (6.1.12)$$

$$u|_{x=0} = \phi, \quad u|_{x=l} = \psi, \quad (6.1.13)$$

$$u|_{t=0} = g(x). \quad (6.1.14)$$

Let us discard initial condition and find a *stationary solution*  $u = v(x)$ :

$$v'' = -\frac{1}{k}f(x), \quad 0 < x < l, \quad (6.1.15)$$

$$v(0) = \phi, \quad v(l) = \psi. \quad (6.1.16)$$

Then (6.1.15) (which is  $v'' = -\frac{1}{k}f(x)$ ) implies

$$v(x) = -\frac{1}{k} \int_0^x \int_0^{x'} f(x'') dx'' dx' + A + Bx = \int_0^x (x-x')f(x') dx' + A + Bx$$

where we used formula of  $n$ -th integral (you must know it from Calculus I)

$$I_n(x) = \frac{1}{(n-1)!} \int_a^x (x-x')^{n-1} f(x') dx' \quad n = 1, 2, \dots \quad (6.1.17)$$

for  $I_n := \int_a^x I_{n-1}(x') dx'$ ,  $I_0(x) := f(x)$ .

Then satisfying b.c.  $A = \phi$  and  $B = \frac{1}{l} \left( \psi - \phi + \frac{1}{k} \int_0^l (l-x')f(x') dx' \right)$  and

$$v(x) = \int_0^x G(x, x')f(x') dx' + \phi \left(1 - \frac{x}{l}\right) + \psi \frac{x}{l} \quad (6.1.18)$$

with *Green's function*

$$G(x, x') = \frac{1}{k} \begin{cases} x'(1 - \frac{x}{l}) & 0 < x' < x, \\ x(1 - \frac{x'}{l}) & x < x' < l. \end{cases} \quad (6.1.19)$$

Returning to the original problem we note that  $u - v$  satisfies (6.1.1)–(6.1.3) with  $g(x)$  replaced by  $g(x) - v(x)$  and therefore  $u - v = O(e^{-k\lambda_1 t})$ . So

$$u = v + O(e^{-k\lambda_1 t}). \quad (6.1.20)$$

In other words, *solution stabilizes to the stationary solution*. For more detailed analysis of BVP for ODEs see Appendix 6.6.2.

### 6.1.3 Other boundary conditions

Similar approach works in the cases of boundary conditions we considered before:

- (a) Dirichlet on one end and Neumann on the other end  $u|_{x=0} = u_x|_{x=l} = 0$ ;
- (b) Neumann on both ends  $u_x|_{x=0} = u_x|_{x=l} = 0$ ;
- (c) Periodic  $u|_{x=l} = u|_{x=0}$ ,  $u_x|_{x=l} = u_x|_{x=0}$ ;
- (d) Dirichlet on one end and Robin on the other  $u|_{x=0} = (u_x + \beta u)|_{x=l} = 0$ ;
- (e) Robin on both ends  $(u_x - \alpha u)|_{x=0} = (u_x + \beta u)|_{x=l} = 0$

but in cases (d) and (e) we cannot find eigenvalues explicitly.

### 6.1.4 Corollaries

All corollaries remain valid as long as  $\lambda_1 > 0$  which happens in cases (a), (d) with  $\beta \geq 0$ , and (e) with  $\alpha \geq 0, \beta \geq 0$  except  $\alpha = \beta = 0$ .

Let us consider what happens when  $\lambda_1 = 0$  (cases (b) and (c)). First, solution of the problem with r.h.e. and b.c. equal to 0 does not decay as  $t \rightarrow +\infty$ , instead

$$u = A_1 + O(e^{-k\lambda_2 t}) \quad (6.1.21)$$

because in cases (b) and (c)  $X_1(x) = 1$ .

Second, solution of stationary problem exists *only conditionally*: iff

$$\frac{1}{k} \int_0^l f(x) dx - \phi + \psi = 0 \quad (6.1.22)$$

in the case of Neumann b.c. on both ends  $u_x|_{x=0} = \phi$ ,  $u_x|_{x=l} = \psi$  and

$$\frac{1}{k} \int_0^l f(x) dx = 0 \quad (6.1.23)$$

in the case of periodic boundary conditions.

To cover the case when (6.1.22) (that is  $\frac{1}{k} \int_0^l f(x) dx - \phi + \psi = 0$ ) or (6.1.23) (that is  $\frac{1}{k} \int_0^l f(x) dx = 0$ ) fails (i.e. total heat flow is not 0 so there

is no balance) it is sufficient to consider the case  $f = p$ ,  $\phi = \psi = 0$ ; then  $u = pt$  with

$$p = \frac{1}{l} \int_0^l f(x) dx \quad (6.1.24)$$

and in the general case

$$u = pt + A_1 + O(e^{-k\lambda_2 t}). \quad (6.1.25)$$

## 6.2 Separation of variables: miscellaneous equations

### 6.2.1 Schrödinger equation

In the previous Section 6.1 we considered heat equation.

Consider problem

$$u_t = ik u_{xx} \quad 0 < x < l, \quad (6.2.1)$$

$$(\alpha_0 u_x - \alpha u)|_{x=0} = (\beta_0 u_x + \beta u)|_{x=l} = 0, \quad (6.2.2)$$

$$u|_{t=0} = g(x) \quad (6.2.3)$$

where *either*  $\alpha_0 = 0$ ,  $\alpha = 1$  and we have a Dirichlet boundary condition *or*  $\alpha_0 = 1$  and we have either Neumann or Robin boundary condition on the left end and the same on the right end  $x = l$ .

Let us consider a simple solution  $u(x, t) = X(x)T(t)$ ; then separating variables we arrive to  $\frac{T'}{T} = ik \frac{X''}{X}$  which implies  $X'' + \lambda X = 0$  and

$$T' = -ik\lambda T \quad (6.2.4)$$

(explain, how). We also get boundary conditions  $(\alpha_0 X' - \alpha X)(0) = (\beta_0 X' + \beta X)(l) = 0$  (explain, how). So, we have eigenvalues  $\lambda_n$  and eigenfunctions  $X_n$  ( $n = 1, 2, \dots$ ) and equation (6.2.4) (which is  $T' = -ik\lambda T$ ) for  $T$ , which results in

$$T_n = A_n e^{-ik\lambda_n t} \quad (6.2.5)$$

and therefore a simple solution is

$$u_n = A_n e^{-ik\lambda_n t} X_n(x) \quad (6.2.6)$$

and we look for a general solution in the form

$$u = \sum_{n=1}^{\infty} A_n e^{-ik\lambda_n t} X_n(x). \quad (6.2.7)$$

Again, taking in account initial condition (6.2.3) we see that

$$u = \sum_{n=1}^{\infty} A_n X_n(x). \quad (6.2.8)$$

and therefore

$$A_n = \frac{1}{\|X_n\|^2} \int_0^l g(x) X_n(x) dx. \quad (6.2.9)$$

*Remark 6.2.1.* (a) Formula (6.2.6) ( $u_n = A_n e^{-ik\lambda_n t} X_n(x)$ ) shows that the problem is well-posed for  $t < 0$  and  $t > 0$ .

(b) However there is no stabilization.

(c) What we got is a finite interval version of analysis of Subsection 5.3.2.

## 6.2.2 1D Wave equation

Consider problem

$$u_{tt} = c^2 u_{xx}, \quad 0 < x < l, \quad (6.2.10)$$

$$(\alpha_0 u_x - \alpha u)|_{x=0} = (\beta_0 u_x + \beta u)|_{x=l} = 0. \quad (6.2.11)$$

$$u|_{t=0} = g(x), \quad u_t|_{t=0} = h(x). \quad (6.2.12)$$

Actually we started from this equation in Section 4.1 but now we consider more general boundary conditions. Now we have

$$T'' = -k\lambda T \quad (6.2.13)$$

and we have

$$T_n = \begin{cases} A_n \cos(\omega_n t) + B_n \sin(\omega_n t), & \omega_n = c\lambda_n^{\frac{1}{2}} & \text{as } \lambda_n > 0, \\ A_n + B_n t & & \text{as } \lambda_n = 0, \\ A_n \cosh(\eta_n t) + B_n \sinh(\eta_n t), & \eta_n = c(-\lambda_n)^{\frac{1}{2}} & \text{as } \lambda_n < 0, \end{cases} \quad (6.2.14)$$

and respectively we get

$$u = \sum_n T_n(t)X_n(x) \quad (6.2.15)$$

and we find from initial conditions

$$A_n = \frac{1}{\|X_n\|^2} \int_0^l g(x)X_n(x) dx, \quad (6.2.16)$$

$$B_n = \frac{1}{\|X_n\|^2} \int_0^l h(x)X_n(x) dx \times \begin{cases} \frac{1}{\omega_n} & \text{as } \lambda_n > 0, \\ 1 & \text{as } \lambda_n = 0, \\ \frac{1}{\eta_n} & \text{as } \lambda_n < 0. \end{cases} \quad (6.2.17)$$

### 6.2.3 Laplace equation in half-strip

Consider problem

$$\Delta u := u_{xx} + u_{yy} = 0, \quad y > 0, \quad 0 < x < l, \quad (6.2.18)$$

$$(\alpha_0 u_x - \alpha u)|_{x=0} = (\beta_0 u_x + \beta u)|_{x=l} = 0, \quad (6.2.19)$$

$$u|_{y=0} = g(x). \quad (6.2.20)$$



To make it uniquely solvable we need to add condition  $|u| \leq M$ . Again separating variables  $u(x, y) = X(x)Y(y)$  we get

$$Y'' = \lambda Y \quad (6.2.21)$$

and therefore *assuming that*  $\lambda > 0$  we get

$$Y = Ae^{-\sqrt{\lambda}y} + Be^{\sqrt{\lambda}y}. \quad (6.2.22)$$



We discard the second term  $Be^{\sqrt{\lambda}y}$  in the right-hand expression of (6.2.22) because it is unbounded. However if we had Cauchy problem (i.e.  $u|_{y=0} = g(x)$ ,  $u_y|_{y=0} = h(x)$ ) we would not be able to do this and this problem will be ill-posed.

So,  $u = Ae^{-\sqrt{\lambda}y}$  and (6.2.20) and

$$u_n = A_n e^{-\sqrt{\lambda_n}y} X_n(x) \quad (6.2.23)$$

and assuming that all  $\lambda_n > 0$  we get

$$u = \sum_n A_n e^{-\sqrt{\lambda_n}y} X_n(x) \quad (6.2.24)$$

and (6.2.20) ( $u|_{y=0} = g(x)$ ) yields

$$A_n = \frac{1}{\|X_n\|^2} \int_0^l g(x) X_n(x) dx. \quad (6.2.25)$$

*Remark 6.2.2.* (a) If there is eigenvalue  $\lambda = 0$  we have  $Y = A + By$  and as we are looking for a bounded solution we discard the second term again; so *our analysis remain valid as all  $\lambda_n \geq 0$ .*

(b) If we have a problem

$$\Delta u := u_{xx} + u_{yy} = 0, \quad y > 0, \quad 0 < x < l, \quad (6.2.26)$$

$$(\alpha_0 u_x - \alpha u)|_{x=0} = \phi(y), \quad (6.2.27)$$

$$(\beta_0 u_x + \beta u)|_{x=l} = \psi(y), \quad (6.2.28)$$

$$u|_{y=0} = g(x) \quad (6.2.29)$$

with  $g(x) = 0$  we could reduce it by the method of continuation to the problem in the whole strip and solve it by Fourier transform (see Subsection 5.3.5).

- (c) In the general case we can find  $u = u_{(1)} + u_{(2)}$  where  $u_{(1)}$  solves problem with  $g = 0$  and  $u_{(2)}$  solves problem with  $\phi = \psi = 0$  (explain how it follows from the linearity).
- (d) One can replace Dirichlet boundary condition  $u|_{y=0}$  by Robin boundary condition  $(u_y - \gamma u)|_{y=0} = g(x)$  ( $\gamma \geq 0$ ) but there is an exceptional case: there is an eigenvalue  $\lambda_0 = 0$  and as  $y = 0$  we have Neumann boundary condition.

- (e) In this exceptional case (usually as we have Neumann boundary conditions everywhere—as  $x = 0$ ,  $x = l$ ,  $y = 0$ ) a required solution simply does not exist unless  $\int_0^l g(x)X_0(x) dx = 0$ .

## 6.2.4 Laplace equation in rectangle

Consider problem

$$\Delta u := u_{xx} + u_{yy} = 0, \quad 0 < y < b, \quad 0 < x < a, \quad (6.2.30)$$

$$(\alpha_0 u_x - \alpha u)|_{x=0} = (\beta_0 u_x + \beta u)|_{x=a} = 0, \quad (6.2.31)$$

$$u|_{y=0} = g(x), \quad (6.2.32)$$

$$u|_{y=b} = h(x). \quad (6.2.33)$$

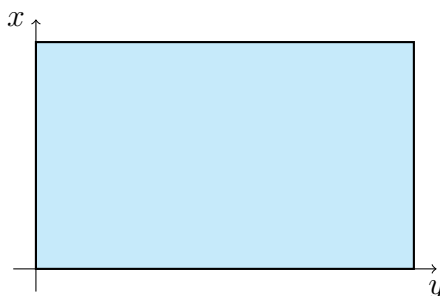

Then we get (6.2.21) and (6.2.22) again but with two boundary conditions we cannot discard anything; we get instead

$$A_n + B_n = g_n, \quad (6.2.34)$$

$$A_n e^{-\sqrt{\lambda_n} b} + B_n e^{\sqrt{\lambda_n} b} = h_n \quad (6.2.35)$$

where  $g_n$  and  $h_n$  are Fourier coefficients of  $g$  and  $h$  respectively, which implies

$$A_n = \frac{e^{\sqrt{\lambda_n} b}}{2 \sinh(\sqrt{\lambda_n} b)} g_n - \frac{1}{2 \sinh(\sqrt{\lambda_n} b)} h_n,$$

$$B_n = -\frac{e^{-\sqrt{\lambda_n} b}}{2 \sinh(\sqrt{\lambda_n} b)} g_n + \frac{1}{2 \sinh(\sqrt{\lambda_n} b)} h_n$$

and therefore

$$Y_n(y) = \frac{\sinh(\sqrt{\lambda_n}(b-y))}{\sinh(\sqrt{\lambda_n}b)}g_n + \frac{\sinh(\sqrt{\lambda_n}y)}{\sinh(\sqrt{\lambda_n}b)}h_n. \quad (6.2.36)$$

One can see easily that  $\frac{\sinh(\sqrt{\lambda_n}(b-y))}{\sinh(\sqrt{\lambda_n}b)}$  and  $\frac{\sinh(\sqrt{\lambda_n}y)}{\sinh(\sqrt{\lambda_n}b)}$  are bounded as  $0 \leq y \leq b$ .

*Problem 6.2.1.* Investigate other boundary conditions (Robin, Neumann, mixed).

*Remark 6.2.3.* (a) There is an exceptional case: there is an eigenvalue  $\lambda_0 = 0$  and as  $y = 0$  and  $y = b$  we have Neumann boundary conditions. Then solution does not exist unless  $\int_0^a h(x)X_0(x) dx - \int_0^a g(x)X_0(x) dx = 0$ .

(b) We can consider general boundary conditions with

$$(\alpha_0 u_x - \alpha u)|_{x=0} = \phi(y), \quad (\beta_0 u_x + \beta u)|_{x=a} = \psi(y).$$

Then we can find  $u = u_{(1)} + u_{(2)}$  where  $u_{(1)}$  solves problem with  $g = h = 0$  and  $u_{(2)}$  solves problem with  $\phi = \psi = 0$  (explain how it follows from the linearity). The second problem is also “our” problem with  $x$  and  $y$  permuted.

(c) Assume that we have Neumann boundary conditions everywhere—as  $x = 0$ ,  $x = a$ ,  $y = 0$ ,  $y = b$ . Then solution does not exist unless

$$\int_0^a h(x) dx - \int_0^a g(x) dx + \int_0^b \psi(y) dy - \int_0^b \phi(y) dy = 0 \quad (6.2.37)$$

which means that the total heat flow is 0. How we can reduce two assumptions

$$\int_0^a h(x) dx - \int_0^a g(x) dx = 0, \quad \int_0^b \phi(x) dy - \int_0^b \psi(y(y)) dy = 0 \quad (6.2.38)$$

to just one (6.2.37)?

We just need to consider some function  $v(x, y)$  with  $\Delta v = 0$ , which satisfies (6.2.37) but not (6.2.38). Let function  $u(x, y)$  with  $\Delta u = 0$  satisfy (6.2.37). Then for some  $A$  function  $w = u - v$  satisfies (6.2.38). We can take  $v = x^2 - y^2$ .

## 6.3 Laplace operator in different coordinates

### 6.3.1 Laplace operator in polar coordinates

In the next several lectures we are going to consider Laplace equation in the disk and similar domains and separate variables there but for this purpose we need to express Laplace operator in the polar coordinates. Recall that (from Calculus I) polar coordinates are  $(r, \theta)$  connected with Cartesian coordinates by  $x = r \cos(\theta)$ ,  $y = r \sin(\theta)$  and conversely

$$\begin{cases} r = \sqrt{x^2 + y^2}, \\ \theta = \arctan\left(\frac{y}{x}\right); \end{cases}$$

surely the second formula is not exactly correct as changing  $(x, y) \rightarrow (-x, -y)$  does not change the ratio but replaces  $\theta$  by  $\theta + \pi$  (or  $\theta - \pi$ ) since  $\theta$  is defined modulo  $2\pi n$  with  $n \in \mathbb{Z}$ . It does not really matter as we are interested only in derivatives:

$$r_x = \cos(\theta), \quad r_y = \sin(\theta), \quad \theta_x = -r^{-1} \sin(\theta), \quad \theta_y = r^{-1} \cos(\theta). \quad (6.3.1)$$

*Exercise 6.3.1.* Prove (6.3.1).

Then by chain rule

$$\begin{cases} \partial_x = \cos(\theta)\partial_r - r^{-1} \sin(\theta)\partial_\theta, \\ \partial_y = \sin(\theta)\partial_r + r^{-1} \cos(\theta)\partial_\theta \end{cases} \quad (6.3.2)$$

and therefore

$$\Delta = \partial_x^2 + \partial_y^2 = (\cos(\theta)\partial_r - r^{-1} \sin(\theta)\partial_\theta)^2 + (\sin(\theta)\partial_r + r^{-1} \cos(\theta)\partial_\theta)^2$$

and after tedious calculations one can get

$$\Delta = \partial_r^2 + \frac{1}{r} \partial_r + \frac{1}{r^2} \partial_\theta^2. \quad (6.3.3)$$

*Exercise 6.3.2.* Do it.

Instead we want to use a different method requiring much less error prone calculations but more delicate arguments (useful in more complicated cases).

Note first the identity

$$\iint \Delta u \cdot v \, dA = - \iint \nabla u \cdot \nabla v \, dA, \quad (6.3.4)$$

with  $dA = dx dy$  and integrals taken over domain  $\mathcal{D}$ , provided  $v = 0$  near  $\Gamma$  (boundary of  $\mathcal{D}$ ) and integrals are taken over  $\mathcal{D}$ .

Now let us express the left- and right-hand expression in the polar coordinates. Recall that polar coordinates are *orthogonal* (i.e. level lines of  $r$  (circles) and level lines of  $\theta$  (rays from the origin) are orthogonal in the points where they intersect) and the distance  $ds$  between two close points can be calculated as

$$ds^2 = dx^2 + dy^2 = dr^2 + r^2 d\theta^2 \quad (6.3.5)$$

and therefore area element is  $dA = dx dy = r dr d\theta$ .

But what about  $\nabla u \cdot \nabla v$ ? We claim that

$$\nabla u \cdot \nabla v = u_r v_r + \frac{1}{r^2} u_\theta v_\theta. \quad (6.3.6)$$

Indeed,  $\nabla u$  is a vector of the different nature than  $d\mathbf{s} = (dx, dy)$ . They are connected by  $du = \nabla u \cdot d\mathbf{s}$  and when we change coordinates  $d\mathbf{s}' = Q d\mathbf{s}$  with some matrix  $Q$ , and since

$$du = \nabla u \cdot d\mathbf{s} = \nabla u' \cdot d\mathbf{s}' = \nabla u' \cdot Q d\mathbf{s} = Q^T \nabla u' \cdot d\mathbf{s}$$

we conclude that  $\nabla u' = Q^{T-1} \nabla u$  where  $T$  means transposed matrix. Such dual vectors mathematicians call *covectors*.

*Remark 6.3.1.* (a) While mathematicians talk about *vectors* and *covectors*, physicists often call them *covariant* and *contravariant* vectors.

- (b) Also there are notions of *pseudo-vectors* (and *pseudo-covectors*) and *pseudo-scalars* which change signs when right-oriented coordinate system is changed to the left-oriented one. F.e. if we restrict ourselves to Cartesian coordinates, vector-product of two vectors is a pseudo-vector, and oriented volume is a pseudo-scalar. Curl of a vector field is a pseudo-vector field. Intensity of magnetic field is a pseudo-vector.
- (c) However for more general coordinate systems there are also *densities* which in addition to usual transformations “reflect” the change of volume.

For us here important is only the difference between vectors and covectors.

Therefore (6.3.4) becomes

$$\begin{aligned} \iint \Delta u \cdot v r dr d\theta &= - \iint (u_r v_r + \frac{1}{r^2} u_\theta v_\theta) r dr d\theta = \\ &= - \iint (r u_r v_r + \frac{1}{r} u_\theta v_\theta) dr d\theta = \iint ((r u_r)_r + (\frac{1}{r} u_\theta)_\theta) v dr d\theta, \end{aligned}$$

where we integrated by parts. This identity

$$\iint r \Delta u \cdot v dr d\theta = \iint (r (r u_r)_r + (\frac{1}{r} u_\theta)_\theta) v dr d\theta.$$

holds for *any*  $v$ , vanishing near  $\Gamma$ , and therefore we can mix both integration and  $v$ :

$$r \Delta u = (r u_r)_r + (\frac{1}{r} u_\theta)_\theta.$$

*Exercise 6.3.3.* Think about this.

Finally we get

$$\Delta u = r^{-1} (r u_r)_r + r^{-1} (r^{-1} u_\theta)_\theta,$$

which is exactly (6.3.3). It may look too complicated for polar coordinates but in more general cases this approach is highly beneficial.

### 6.3.2 Laplace operator in spherical coordinates

Spherical coordinates are  $\rho$  (radius),  $\phi$  (latitude) and  $\theta$  (longitude):

$$\begin{cases} x = \rho \sin(\phi) \cos(\theta), \\ y = \rho \sin(\phi) \sin(\theta) \\ z = \rho \cos(\phi). \end{cases}$$

Conversely

$$\begin{cases} \rho = \sqrt{x^2 + y^2 + z^2}, \\ \phi = \arctan\left(\frac{\sqrt{x^2 + y^2}}{z}\right), \\ \theta = \arctan\left(\frac{y}{x}\right); \end{cases}$$

and using chain rule and “simple” calculations becomes rather challenging.

Instead we recall that these coordinates are also orthogonal: if we fix  $\phi$  and  $\theta$  we get rays from origin, which are orthogonal to the spheres which we get if we fix  $r$ . On the spheres if we fix  $\theta$  we get meridians and if we fix  $\phi$  we get parallels and those are also orthogonal. Then

$$ds^2 = dx^2 + dy^2 + dz^2 = d\rho^2 + \rho^2 d\phi^2 + \rho^2 \sin^2(\phi) d\theta^2, \quad (6.3.5)'$$

where  $d\rho$ ,  $\rho d\phi$  and  $\rho \sin(\phi) d\theta$  are distances along rays, meridians and parallels and therefore the volume element is  $dV = dx dy dz = \rho^2 \sin(\phi) d\rho d\phi d\theta$ .

Therefore

$$\nabla u \cdot \nabla v = u_\rho v_\rho + \frac{1}{\rho^2} u_\phi v_\phi + \frac{1}{\rho^2 \sin^2(\phi)} u_\theta v_\theta. \quad (6.3.6)'$$

Plugging this into

$$\iiint \Delta u \cdot v \, dx dy dz = - \iiint \nabla u \cdot \nabla v \, dx dy dz, \quad (6.3.4)'$$

we get

$$\begin{aligned} & \iiint \Delta u \cdot v \rho^2 \sin(\phi) \, d\rho d\phi d\theta \\ &= - \iiint \left( u_\rho v_\rho + \frac{1}{\rho^2} u_\phi v_\phi + \frac{1}{\rho^2 \sin^2(\phi)} u_\theta v_\theta \right) \rho^2 \sin(\phi) \, d\rho d\phi d\theta \\ &= \iiint \left( (\rho^2 \sin(\phi) u_\rho)_\rho + (\sin(\phi) u_\phi)_\phi + \left( \frac{1}{\sin(\phi)} u_\theta \right)_\theta \right) v \, d\rho d\phi d\theta. \end{aligned}$$

Then we can mix integration and factor  $v$ :

$$\Delta u \cdot \rho^2 \sin(\phi) = (\rho^2 \sin(\phi) u_\rho)_\rho + (\sin(\phi) u_\phi)_\phi + \left( \frac{1}{\sin(\phi)} u_\theta \right)_\theta$$

and then

$$\Delta u = \frac{1}{\rho^2 \sin(\phi)} \left( (\rho^2 \sin(\phi) u_\rho)_\rho + (\sin(\phi) u_\phi)_\phi + \left( \frac{1}{\sin(\phi)} u_\theta \right)_\theta \right)$$

and finally

$$\Delta = \partial_\rho^2 + \frac{2}{\rho} \partial_\rho + \frac{1}{\rho^2} (\partial_\phi^2 + \cot(\phi) \partial_\phi) + \frac{1}{\rho^2 \sin^2(\phi)} \partial_\theta^2. \quad (6.3.7)$$

Compare with (6.3.3).

**Definition 6.3.1.**

$$\Lambda := \partial_\phi^2 + \cot(\phi)\partial_\phi + \frac{1}{\sin^2(\phi)}\partial_\theta^2 \quad (6.3.8)$$

is a *spherical Laplacian* (a.k.a. Laplace-Beltrami operator on the sphere).

**6.3.3 Special knowledge: generalization**

If the length element is

$$ds^2 = \sum_{j,k} g_{jk} dq^j dq^k \quad (6.3.5)''$$

where  $q = (q^1, \dots, q^n)$  are new coordinates and we prefer to write  $dq^j$  rather than  $dq_j$  (to half-follow Einstein's notations) and  $g_{jk}$  is symmetric matrix ( $g^{kj} = g^{jk}$ ), then

$$\nabla u \cdot \nabla v = \sum_{j,k} g^{jk} u_{q^j} v_{q^k} \quad (6.3.6)''$$

where  $(g^{jk})$  is an inverse matrix to  $(g_{jk})$ :  $\sum_k g^{jk} g_{kl} = \sum_k g_{lk} g^{kj} = \delta_l^j$ .

Then the volume element is  $dV = |\det(g_{jk})|^{\frac{1}{2}} dq^1 \cdots dq^n$  and

$$\Delta u = |\det(g_{jk})|^{-\frac{1}{2}} \sum_{j,k} \frac{\partial}{\partial q^j} \left( |\det(g_{jk})|^{\frac{1}{2}} g^{jk} \frac{\partial u}{\partial q^k} \right). \quad (6.3.9)$$

Indeed,

$$\begin{aligned} \iiint \nabla u \cdot \nabla v \, dV &= \iiint \sum_{j,k} g^{jk} u_{q^k} v_{q^j} |\det(g_{jk})|^{\frac{1}{2}} dq^1 \cdots dq^n \\ &= \iiint \sum_{j,k} \frac{\partial}{\partial q^j} \left( |\det(g_{jk})|^{\frac{1}{2}} g^{jk} \frac{\partial u}{\partial q^k} \right) v \, dq^1 \cdots dq^n = \\ &= \iiint |\det(g_{jk})|^{-\frac{1}{2}} \sum_{j,k} \frac{\partial}{\partial q^j} \left( |\det(g_{jk})|^{\frac{1}{2}} g^{jk} \frac{\partial u}{\partial q^k} \right) v \, dV \end{aligned}$$

where transition between the first and second lines is due to integration by parts.



*Remark 6.3.2.* (a) Formula (6.3.9) defines Laplace operator on *Riemannian manifolds* (like surfaces in 3D) where Cartesian coordinates do not exist at all. Such manifolds are studied in the *Riemannian geometry* and are used f.e. in the *General relativity*.

(b) Actually GR uses *pseudo-Riemannian manifolds* because matrix  $(g_{jk})$  is not positively definite there but has a signature  $\langle +, +, +, - \rangle$  (or the other way around). In the pseudo-Euclidean coordinates of the *Special relativity*  $ds^2 = dx^2 + dy^2 + dz^2 - c^2 dt^2$  and instead of Laplacian  $\Delta$  we get *D'Alembertian*  $\square = \Delta - c^{-2} \partial_t^2$ .

### 6.3.4 Secret knowledge: elliptic and parabolic coordinates

**Elliptic coordinates** on  $\mathbb{R}^2$  are  $(\sigma, \tau)$ :

$$\begin{cases} x = c \cosh(\sigma) \cos(\tau), \\ y = c \sinh(\sigma) \sin(\tau). \end{cases} \quad (6.3.10)$$

Level lines  $\sigma = \text{const}$  are ellipses with foci at  $(-c, 0)$  and  $(c, 0)$  and level lines  $\tau = \text{const}$  are hyperbolae with the same foci; so we have confocal ellipses and hyperbolae.

These coordinates are not only orthogonal but they are *conformal* ( $ds^2$  is proportional to  $d\sigma^2 + d\tau^2$ )

$$ds^2 = (\sinh^2(\sigma) + \sin^2(\tau))(d\sigma^2 + d\tau^2) \quad (6.3.11)$$

and therefore

$$\Delta = \frac{1}{c^2(\sinh^2(\sigma) + \sin^2(\tau))}(\partial_\sigma^2 + \partial_\tau^2). \quad (6.3.12)$$

**Elliptic cylindrical coordinates** in  $\mathbb{R}^3$  are obtained by adding  $z$  to elliptic coordinates.

**Parabolic coordinates** on  $\mathbb{R}^2$  are  $(\sigma, \tau)$ :

$$\begin{cases} x = \sigma\tau, \\ y = \frac{1}{2}(\sigma^2 - \tau^2). \end{cases} \quad (6.3.13)$$

Level lines  $\sigma = \text{const}$  and  $\tau = \text{const}$  are confocal parabolae.

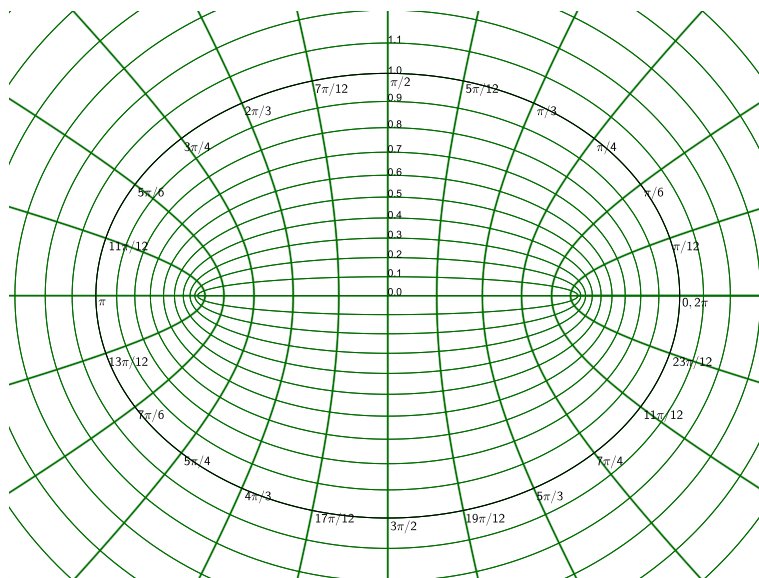
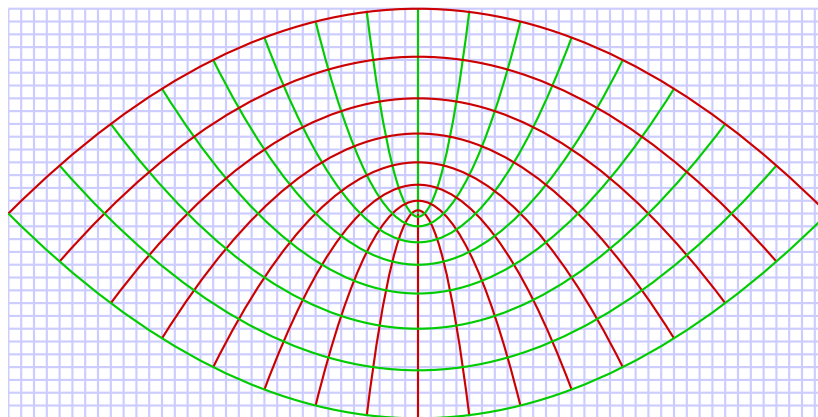
Figure 6.1: Elliptic coordinate system; from [Wikipedia](#)Figure 6.2: Parabolic coordinate system; from [Wikipedia](#)

These coordinates are also *conformal*

$$ds^2 = (\sigma^2 + \tau^2)(d\sigma^2 + d\tau^2) \quad (6.3.14)$$

and therefore

$$\Delta = \frac{1}{\sigma^2 + \tau^2}(\partial_\sigma^2 + \partial_\tau^2). \quad (6.3.15)$$

*Remark 6.3.3.* (a) In conformal coordinates angles are the same as in Euclidean coordinates.

(b) In 2D conformal coordinates are plentiful and closely connected to “Complex Variables”. In particular, elliptic coordinates are  $x + yi = c \cosh(\sigma + i\tau)$  and parabolic coordinates are  $x + yi = -\frac{i}{2}(\sigma + i\tau)^2$ ;

(c) But in higher dimensions there are very few of them. See also 3D coordinate systems (which are not conformal):

**Three-dimensional parabolic coordinates** are obtained by rotating the two-dimensional system about the symmetry axis of the parabolae.

**Parabolic cylindrical coordinates** in  $\mathbb{R}^3$  are obtained by adding  $z$  to parabolic coordinates.

## 6.4 Laplace operator in the disk

### 6.4.1 Separation of variables

So, consider problem

$$\begin{aligned} \Delta u &= 0 && \text{as } x^2 + y^2 < a^2, \\ u &= g && \text{at } x^2 + y^2 = a^2. \end{aligned}$$

In the polar coordinates it becomes

$$u_{rr} + \frac{1}{r}u_r + \frac{1}{r^2}u_{\theta\theta} = 0 \quad \text{as } r < a, \quad (6.4.1)$$

$$u = g(\theta) \quad \text{at } r = a. \quad (6.4.2)$$

First let us forget for a while about (6.4.2) and consider a simple solution  $u = R(r)\Theta(\theta)$  to equation (6.4.1). Then

$$R''\Theta + \frac{1}{r}R'\Theta + \frac{1}{r^2}R\Theta'' = 0.$$

To separate  $r$  and  $\theta$  we must divide by  $R\Theta$  and multiply by  $r^2$ :

$$\underbrace{\frac{r^2 R'' + r R'}{R}} + \underbrace{\frac{\Theta''}{\Theta}} = 0.$$

Then repeating our usual separation of variables magic spell both expressions are constant, say  $\lambda$  and  $-\lambda$ :

$$r^2 R'' + rR' - \lambda R = 0, \quad (6.4.3)$$

$$\Theta'' + \lambda\Theta = 0. \quad (6.4.4)$$

Now we need boundary conditions to  $\Theta$  and those are periodic:

$$\Theta(2\pi) = \Theta(0), \quad \Theta'(2\pi) = \Theta'(0). \quad (6.4.5)$$

We already know solution to (6.4.4)–(6.4.5):

$$\lambda_0 = 0, \quad \lambda_n = n^2, \quad n = 1, 2, \dots \quad (6.4.6)$$

$$\Theta_0 = \frac{1}{2} \quad \Theta_{n,1} = \cos(n\theta), \quad \Theta_{n,2} = \sin(n\theta). \quad (6.4.7)$$

Equation (6.4.3) is an Euler equation, we are looking for solutions  $R = r^m$ . Then

$$m(m-1) + m - \lambda = 0 \implies m^2 = \lambda. \quad (6.4.8)$$

Plugging  $\lambda_n = n^2$  into (6.4.8) we get  $m = \pm n$  and therefore  $R = Ar^n + Br^{-n}$  as  $n \neq 0$  and  $R = A + B \log(r)$  as  $n = 0$ . Therefore

$$u = \frac{1}{2}(A_0 + B_0 \log(r)) + \sum_{n=1}^{\infty} \left( (A_n r^n + B_n r^{-n}) \cos(n\theta) + (C_n r^n + D_n r^{-n}) \sin(n\theta) \right). \quad (6.4.9)$$

Here we assembled simple solutions together.

Since we are looking for solutions in the disk  $\{r < a\}$  we should discard terms singular as  $r = 0$ ; namely we should set  $B_0 = 0$ ,  $B_n = D_n = 0$  for  $n = 1, 2, \dots$  and therefore

$$u = \frac{1}{2}A_0 + \sum_{n=1}^{\infty} r^n \left( A_n \cos(n\theta) + C_n \sin(n\theta) \right). \quad (6.4.10)$$

If we consider equation outside the disk (so as  $r > a$ ) we need to impose condition  $\max |u| < \infty$  and discard terms singular as  $r = \infty$ ; namely we should set  $B_0 = 0$ ,  $A_n = C_n = 0$  for  $n = 1, 2, \dots$  and therefore

$$u = \frac{1}{2}A_0 + \sum_{n=1}^{\infty} r^{-n} \left( B_n \cos(n\theta) + D_n \sin(n\theta) \right). \quad (6.4.11)$$

Finally, if we consider equation in the annulus (a.k.a. ring)  $\{a < r < b\}$  we need boundary conditions on both circles  $\{r = a\}$  and  $\{r = b\}$  and we discard no terms.

### 6.4.2 Poisson formula

But we are dealing with the disk. Plugging (6.4.10) into boundary condition (6.4.2) we get

$$g(\theta) = \frac{1}{2}A_0 + \sum_{n=1}^{\infty} a^n \left( A_n \cos(n\theta) + C_n \sin(n\theta) \right) \quad (6.4.12)$$

and therefore

$$\begin{aligned} A_n &= \frac{1}{\pi} a^{-n} \int_0^{2\pi} g(\theta') \cos(n\theta') d\theta', \\ C_n &= \frac{1}{\pi} a^{-n} \int_0^{2\pi} g(\theta') \sin(n\theta') d\theta'. \end{aligned}$$

Plugging into (6.4.10) we get

$$u(r, \theta) = \int_0^{2\pi} G(r, \theta, \theta') g(\theta') d\theta' \quad (6.4.13)$$

with

$$\begin{aligned} G(r, \theta, \theta') &:= \frac{1}{2\pi} \left( 1 + 2 \sum_{n=1}^{\infty} r^n a^{-n} (\cos(n\theta) \cos(n\theta') + \sin(n\theta) \sin(n\theta')) \right) \\ &= \frac{1}{2\pi} \left( 1 + 2 \sum_{n=1}^{\infty} r^n a^{-n} \cos(n(\theta - \theta')) \right) \\ &= \frac{1}{2\pi} \left( 1 + 2 \operatorname{Re} \sum_{n=1}^{\infty} (ra^{-1} e^{i(\theta - \theta')})^n \right) \\ &= \frac{1}{2\pi} \left( 1 + 2 \operatorname{Re} \frac{ra^{-1} e^{i(\theta - \theta')}}{1 - ra^{-1} e^{i(\theta - \theta')}} \right) \end{aligned}$$

where we summed geometric progression with the factor  $z = ra^{-1} e^{i(\theta - \theta')}$  (then  $|z| = ra^{-1} < 1$ ).

Multiplying numerator and denominator by complex conjugate to denominator  $(a^2 - rae^{-i(\theta-\theta')})$  we get correspondingly  $(rae^{-i(\theta-\theta')} - r^2)$  and

$$a^2 - ra[e^{-i(\theta-\theta')} + e^{i(\theta-\theta')}] + r^2a^{-2} = a^2 - 2ra \cos(\theta - \theta') + r^2$$

and therefore we get

$$G(r, \theta, \theta') = \frac{1}{2\pi} \left( 1 + 2 \frac{ra \cos(\theta - \theta') - r^2}{a^2 - 2ra \cos(\theta - \theta') + r^2} \right)$$

and finally

$$G(r, \theta, \theta') = \frac{a^2 - r^2}{2\pi(a^2 - 2ra \cos(\theta - \theta') + r^2)}. \quad (6.4.14)$$

Recall that  $r < a$ .

Formula

$$u(r, \theta) = \int_0^{2\pi} G(r, \theta, \theta') g(\theta') d\theta', \quad (13)$$

$$G(r, \theta, \theta') = \frac{a^2 - r^2}{2\pi(a^2 - 2ra \cos(\theta - \theta') + r^2)}. \quad (14)$$

is *Poisson formula*.

*Exercise 6.4.1.* Prove that in the center of the disk (as  $r = 0$ )

$$u(0) = \frac{1}{2\pi} \int_0^{2\pi} g(\theta') d\theta' \quad (6.4.15)$$

and the right-hand expression is a mean value of  $u$  over circumference  $\{r = a\}$ .

*Exercise 6.4.2.* (a) Using (6.4.11) instead of (6.4.10) prove that for the problem

$$u_{rr} + \frac{1}{r}u_r + \frac{1}{r^2}u_{\theta\theta} = 0 \quad \text{as } a < r, \quad (6.4.16)$$

$$u = g(\theta) \quad \text{at } r = a, \quad (6.4.17)$$

$$\max |u| < \infty \quad (6.4.18)$$

solution is given (for  $r > a$ ) by (6.4.13) but with

$$G(r, \theta, \theta') = \frac{r^2 - a^2}{2\pi(a^2 - 2ra \cos(\theta - \theta') + r^2)}. \quad (6.4.19)$$

(b) As a corollary, prove that

$$u(\infty) := \lim_{r \rightarrow \infty} u = \frac{1}{2\pi} \int_0^{2\pi} g(\theta') d\theta'. \quad (6.4.20)$$

## 6.5 Laplace operator in the disk. II

### 6.5.1 Neumann problem

Consider now Neumann problem

$$u_{rr} + \frac{1}{r}u_r + \frac{1}{r^2}u_{\theta\theta} = 0 \quad \text{as } r < a, \quad (6.5.1)$$

$$u_r = h(\theta) \quad \text{at } r = a. \quad (6.5.2)$$

Plugging into (6.5.2) expression (6.4.10) of the previous Section 6.4

$$u = \frac{1}{2}A_0 + \sum_{n=1}^{\infty} r^n (A_n \cos(n\theta) + C_n \sin(n\theta)) \quad (6.4.10)$$

we get

$$\sum_{n=1}^{\infty} na^{n-1} (A_n \cos(n\theta) + C_n \sin(n\theta)) = h(\theta) \quad (6.5.3)$$

and feel trouble!

(a) We cannot satisfy (6.5.3) unless  $h(\theta)$  has a “free” coefficient equal to 0 i.e.

$$\int_0^{2\pi} h(\theta) d\theta = 0. \quad (6.5.4)$$

(b) Even if (6.5.4) holds we cannot find  $A_0$  so in the end solution is defined up to a constant.

So to cure (a) assume that (6.5.4) is fulfilled and to fix (b) impose condition

$$\iint_{\mathcal{D}} u(x, y) dx dy = 0. \quad (6.5.5)$$

(Indeed, it is  $\iint u(r, \theta) r dr d\theta = \pi a^2 A_0$ ). Then  $A_0 = 0$  and

$$\begin{aligned} A_n &= \frac{1}{\pi n} a^{1-n} \int_0^{2\pi} h(\theta') \cos(n\theta') d\theta', \\ C_n &= \frac{1}{\pi n} a^{1-n} \int_0^{2\pi} h(\theta') \sin(n\theta') d\theta'. \end{aligned}$$

Plugging into (6.4.10) we have

$$u(r, \theta) = \int_0^{2\pi} G(r, \theta, \theta') h(\theta') d\theta' \quad (6.5.6)$$

with

$$\begin{aligned} G(r, \theta, \theta') &:= \frac{1}{\pi} \left( \sum_{n=1}^{\infty} \frac{1}{n} r^n a^{1-n} (\cos(n\theta) \cos(n\theta') + \sin(n\theta) \sin(n\theta')) \right) = \\ &= \frac{1}{\pi} \left( \sum_{n=1}^{\infty} \frac{1}{n} r^n a^{1-n} \cos(n(\theta - \theta')) \right) = \\ &= \frac{a}{\pi} \left( \operatorname{Re} \sum_{n=1}^{\infty} \frac{1}{n} (ra^{-1} e^{i(\theta - \theta')})^n \right) = \\ &= -\frac{a}{\pi} \operatorname{Re} \log(1 - ra^{-1} e^{i(\theta - \theta')}) \end{aligned}$$

where we used that  $\sum_{n=1}^{\infty} \frac{1}{n} z^n = -\log(1 - z)$  (indeed, if we denote it by  $f(z)$  then  $f'(z) = \sum_{n=1}^{\infty} z^{n-1} = (1 - z)^{-1}$  and  $f(0) = 0$ ) and plugged  $z = ra^{-1} e^{i(\theta - \theta')}$  with  $|z| < 1$ . The last expression equals

$$\begin{aligned} -\frac{a}{2\pi} \log[(1 - ra^{-1} e^{i(\theta - \theta')})(1 - ra^{-1} e^{-i(\theta - \theta')})] \\ = -\frac{a}{2\pi} \log[a^{-2}(a^2 - 2ar \cos(\theta - \theta') + r^2)]. \end{aligned}$$

with

$$G(r, \theta, \theta') = -\frac{a}{2\pi} \log[a^{-2}(a^2 - 2ar \cos(\theta - \theta') + r^2)]. \quad (6.5.7)$$

Recall that  $r < a$ .

Considering outside the disk we should use (6.4.11)

$$u = \frac{1}{2} A_0 + \sum_{n=1}^{\infty} r^{-n} (B_n \cos(n\theta) + D_n \sin(n\theta)). \quad (6.4.11)$$



Again we need to impose condition (6.5.4); condition (6.5.5) is now replaced by

$$\lim_{r \rightarrow \infty} u = 0. \quad (6.5.8)$$

Then  $A_0 = 0$  and

$$B_n = -\frac{1}{\pi} \frac{1}{n} a^{n+1} \int_0^{2\pi} h(\theta') \cos(n\theta') d\theta',$$

$$D_n = -\frac{1}{\pi} \frac{1}{n} a^{n+1} \int_0^{2\pi} h(\theta') \sin(n\theta') d\theta'.$$

Plugging into (6.4.11) we get (6.5.6) with

$$G(r, \theta, \theta') = \frac{a}{2\pi} \log[r^{-2}(a^2 - 2ar \cos(\theta - \theta') + r^2)]. \quad (6.5.9)$$

### 6.5.2 Laplace equation in the sector

Consider now our equation in the sector  $\{r < a, 0 < \theta < \alpha\}$  and impose 0 Dirichlet boundary conditions at radial parts of the boundary and non-zero on the circular part. Consider now Dirichlet problem

$$u_{rr} + \frac{1}{r} u_r + \frac{1}{r^2} u_{\theta\theta} = 0 \quad \text{as } r < a, 0 < \theta < \alpha \quad (6.5.10)$$

$$u(r, 0) = u(r, \alpha) = 0 \quad 0 < r < a, \quad (6.5.11)$$

$$u = h(\theta) \quad \text{at } r = a, 0 < \theta < \alpha. \quad (6.5.12)$$

*Remark 6.5.1.* We can consider different boundary conditions on these three parts of the boundary, trouble is when Neumann is everywhere.

Then separating variables as in Section 6.4 we get

$$\Theta'' + \lambda\Theta = 0,$$

$$\Theta(0) = \Theta(\alpha) = 0$$

and therefore

$$\lambda_n = \left(\frac{\pi n}{\alpha}\right)^2, \quad \Theta_n = \sin\left(\frac{\pi n \theta}{\alpha}\right) \quad n = 1, 2, \dots$$

and plugging into

$$r^2 R'' + rR' - \lambda R = 0 \quad (6.4.3)$$

we get

$$R_n = A_n r^{\frac{\pi n}{\alpha}} + B_n r^{-\frac{\pi n}{\alpha}} \quad (6.5.13)$$

and therefore

$$u = \sum_{n=1}^{\infty} (A_n r^{\frac{\pi n}{\alpha}} + B_n r^{-\frac{\pi n}{\alpha}}) \sin\left(\frac{\pi n \theta}{\alpha}\right) \quad (6.5.14)$$

where

- (a) For sector  $\{r < a, 0 < \theta < \alpha\}$  we should set  $B_n = 0$
- (b) For domain  $\{r > a, 0 < \theta < \alpha\}$  we should set  $A_n = 0$  and
- (c) For domain  $\{a < r < b, 0 < \theta < \alpha\}$  we don't mix anything.

The rest is easy except we don't get nice formula like Poisson formula.

*Example 6.5.1.* In the half-ring  $\{(r, \theta) : 1 < r < 2, 0 < \theta < \pi\}$  find solution by a Fourier method

$$\begin{aligned} \Delta u &= 0, \\ u|_{\theta=0} &= u|_{\theta=\pi} = 0, \\ u|_{r=1} &= 0, \\ u|_{r=2} &= \pi - \theta. \end{aligned}$$

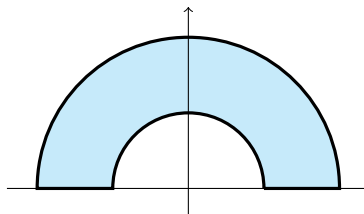

*Solution.* Separating variables  $u(r, \theta) = R(r)\Theta(\theta)$  we get  $\Theta'' + \lambda\Theta = 0$ ,  $\Theta(0) = \Theta(\pi) = 0$ .

Solving Sturm–Liouville problem we get

$$\lambda_n = n^2, \quad \Theta_n = \sin(n\theta) \quad n = 1, 2, \dots \implies R_n = A_n r^n + B_n r^{-n}$$

and therefore

$$u(r, \theta) = \sum_{n=1}^{\infty} [A_n r^n + B_n r^{-n}] \sin(n\theta).$$

Plugging into boundary conditions as  $r = 1$  and  $r = 2$  we get correspondingly

$$\begin{cases} \sum_{n=1}^{\infty} [A_n + B_n] \sin(n\theta) = 0 \implies A_n + B_n = 0, \\ \sum_{n=1}^{\infty} [2^n A_n + 2^{-n} B_n] \sin(n\theta) = \pi - \theta \end{cases}$$

and therefore

$$2^n A_n + 2^{-n} B_n = \frac{2}{\pi} \int_0^\pi (\pi - \theta) \sin(n\theta) d\theta = \frac{2}{n}.$$

Then

$$A_n = -B_n = \frac{2}{(2^n - 2^{-n})n}$$

and

$$u(r, \theta) = \sum_{n=1}^{\infty} \frac{2}{(2^n - 2^{-n})n} (r^n - r^{-n}) \sin(n\theta).$$

□

*Example 6.5.2.* In the disk with a cut  $\{(r, \theta) : r < 1, -\pi < \theta < \pi\}$  find solution by a Fourier method

$$\begin{aligned} \Delta u &= 0, \\ u|_{\theta=-\pi} &= u|_{\theta=\pi} = 1 - r, \\ u|_{r=1} &= 0. \end{aligned}$$

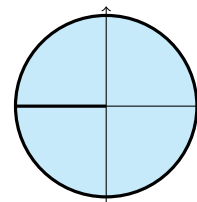

*Solution.* We cannot apply method directly since conditions at the cut are inhomogeneous. However note that  $v = 1 + x$  satisfies both equation and conditions at the cut, so  $u = v + w$  where

$$\begin{aligned} \Delta w &= 0, \\ w|_{\theta=-\pi} &= w|_{\theta=\pi} = 0, \\ w|_{r=1} &= -x - 1 = -1 - \cos(\theta). \end{aligned}$$

Then after separation of variables we get  $\Theta'' + \lambda\Theta = 0$ ,  $\Theta(-\pi) = \Theta(\pi) = 0$  and then  $\lambda = \frac{n^2}{4}$ ,  $\Theta_n = \sin(\frac{n}{2}(\theta + \pi))$ ,  $n = 1, 2, \dots$ . Observe that for  $\Theta_n$  are even/odd with respect to  $\theta$  as  $n$  is odd/even respectively and since  $g(\theta) = -1 - \cos(\theta)$  is even, we need to consider only odd  $n$ :

$$w(r, \theta) = \sum_{n=0}^{\infty} A_n r^{(n+\frac{1}{2})} \cos((n + \frac{1}{2})\theta)$$

with

$$\begin{aligned} A_n &= -\frac{2}{\pi} \int_0^\pi (1 + \cos(\theta)) \cos\left(\left(n + \frac{1}{2}\right)\theta\right) d\theta \\ &= -\frac{1}{\pi} \int_0^\pi \left(2 \cos\left(\left(n + \frac{1}{2}\right)\theta\right) + \cos\left(\left(n + \frac{3}{2}\right)\theta\right) + \cos\left(\left(n - \frac{1}{2}\right)\theta\right)\right) d\theta \\ &= \frac{(-1)^{n-1}}{\pi} \left[-\frac{2}{n + \frac{1}{2}} + \frac{1}{n + \frac{3}{2}} + \frac{1}{n - \frac{1}{2}}\right] = \frac{2(-1)^{n-1}}{\pi\left(n - \frac{1}{2}\right)\left(n + \frac{1}{2}\right)\left(n + \frac{3}{2}\right)}. \end{aligned}$$

Then

$$w(r, \theta) = \sum_{n=0}^{\infty} \frac{2(-1)^{n-1}}{\pi\left(n - \frac{1}{2}\right)\left(n + \frac{1}{2}\right)\left(n + \frac{3}{2}\right)} r^{(n+\frac{1}{2})} \cos\left(\left(n + \frac{1}{2}\right)\theta\right)$$

and

$$u(r, \theta) = 1 + r \cos(\theta) + \sum_{n=0}^{\infty} \frac{2(-1)^{n-1}}{\pi\left(n - \frac{1}{2}\right)\left(n + \frac{1}{2}\right)\left(n + \frac{3}{2}\right)} r^{(n+\frac{1}{2})} \cos\left(\left(n + \frac{1}{2}\right)\theta\right).$$

□

## 6.6 Multidimensional equations

### 6.6.1 Non-stationary equations

We consider only wave equation

$$u_{tt} - c^2 \Delta u = 0 \tag{6.6.1}$$

in the *rectangular box*  $\Omega = \{\mathbf{x} = (x_1, x_2, \dots, x_n) : 0 < x_1 < a_1, \dots, 0 < x_n < a_n\}$ .

For  $n = 2$  we have a rectangle  $\Omega = \{(x, y) : 0 < x < a, 0 < y < b\}$ . Then, plugging  $u(x, y, t) = X(x)Y(y)T(t)$  we get

$$T''(t)X(x)Y(y) - c^2 T(t)X''(x)Y(y) - c^2 T(t)X(x)Y''(y),$$

which can be rewritten as

$$\underbrace{\frac{T''(t)}{T(t)}} - c^2 \underbrace{\frac{X''(x)}{X(x)}} - c^2 \underbrace{\frac{Y''(y)}{Y(y)}} = 0. \tag{6.6.2}$$

Observe that each of selected terms depends only on it's own variable, and repeating arguments of 1D-case we conclude that it must be a constant:

$$\frac{X''}{X} = -\lambda, \quad \frac{Y''}{Y} = -\mu, \quad \frac{T''}{T} = -\nu = -c^2(\lambda + \mu).$$

In other words

$$X'' + \lambda X = 0, \quad Y'' + \mu Y = 0, \quad T'' + \nu T = 0. \quad (6.6.3)$$

Next, we assume that  $u$  must satisfy Dirichlet boundary conditions:

$$u|_{\Gamma} = 0, \quad (6.6.4)$$

where  $\Gamma = \partial\Omega$  is the boundary of  $\Omega$ , which in our case consists of four segments  $\{(x, y): x = 0, 0 < y < b\}$ ,  $\{(x, y): x = a, 0 < y < b\}$ ,  $\{(x, y): y = 0, 0 < x < a\}$ ,  $\{(x, y): y = b, 0 < x < a\}$ .

In  $n$ -dimensional case  $\Gamma$  consists of  $2n$  rectangular boxes of dimension  $(n - 1)$  each.

Then, repeating arguments of 1D-case we conclude that

$$X(0) = X(a) = 0, \quad Y(0) = Y(b) = 0. \quad (6.6.5)$$

Thus we got the same problems for  $X$  and for  $Y$  as in 1D-case, and therefore

$$X_m(x) = \sin\left(\frac{\pi m x}{a}\right), \quad Y_n(y) = \sin\left(\frac{\pi n y}{b}\right), \quad (6.6.6)$$

$$\lambda_m = \left(\frac{\pi m}{a}\right)^2, \quad \mu_n = \left(\frac{\pi n}{b}\right)^2 \quad (6.6.7)$$

with  $m, n = 1, 2, \dots$ , and therefore

$$T_{mn}(t) = A_{mn} \cos(\omega_{mn}t) + B_{mn} \sin(\omega_{mn}t), \quad (6.6.8)$$

$$\omega_{mn} = c\pi \left(\frac{m^2}{a^2} + \frac{n^2}{b^2}\right)^{\frac{1}{2}}. \quad (6.6.9)$$

Finally,

$$u_{mn}(x, y, t) = \left(A_{mn} \cos(\omega_{mn}t) + B_{mn} \sin(\omega_{mn}t)\right) \sin\left(\frac{\pi m x}{a}\right) \sin\left(\frac{\pi n y}{b}\right) \quad (6.6.10)$$

and the general solution is derived in the form of *multidimensional Fourier series* (see Appendix 4.B)

$$u(x, y, t) = \sum_{m=1}^{\infty} \sum_{n=1}^{\infty} \left( A_{mn} \cos(\omega_{mn}t) + B_{mn} \sin(\omega_{mn}t) \right) \sin\left(\frac{\pi mx}{a}\right) \sin\left(\frac{\pi ny}{b}\right). \quad (6.6.11)$$

One can find coefficients from initial conditions  $u|_{t=0} = g(x, y)$  and  $u_t|_{t=0} = h(x, y)$ .

### Visual Examples (animation)

*Remark 6.6.1.* While solution (6.6.10) is periodic with respect to  $t$ , solution (6.6.11) is not (in the generic case).

*Remark 6.6.2.* (a) The same arguments work in higher dimensions.

(b) The same arguments work for Neumann and Robin boundary conditions and on each face of  $\Gamma$  could be its own boundary condition.

(c) The same arguments work for many other equations, like heat equation, or Schrödinger equation.

## 6.6.2 Stationary equations

Consider Laplace equation in the rectangular box  $\Omega$ , with the Dirichlet boundary conditions on  $\Gamma = \partial\Omega$ :

$$\Delta u = 0, \quad (6.6.12)$$

$$u|_{\gamma} = g. \quad (6.6.13)$$

We consider  $n = 3$ , so  $\Omega = \{(x, y, z) : 0 < x < a, 0 < y < b, 0 < z < c\}$ . Without any loss of the generality we can assume that  $g = 0$  on all faces, except two opposite  $z = 0$  and  $z = c$ .

Again we are looking for solution  $u(x, y, z) = X(x)Y(y)Z(z)$  and separating variables we get

$$\underbrace{\frac{X''(x)}{X(x)}} + \underbrace{\frac{Y''(y)}{Y(y)}} + \underbrace{\frac{Z''(z)}{Z(z)}} = 0 \quad (6.6.14)$$

and therefore

$$X'' + \lambda X = 0, \quad Y'' + \mu Y = 0, \quad Z'' - \nu Z = 0 \quad (6.6.15)$$

with  $\nu = \lambda + \mu$ .

We also get (6.6.5) (that is  $X(0) = X(a) = 0$ ,  $Y(0) = Y(b) = 0$ ) and then

$$X_m(x) = \sin\left(\frac{\pi m x}{a}\right), \quad Y_n(y) = \sin\left(\frac{\pi n y}{b}\right), \quad (6)$$

$$\lambda_m = \left(\frac{\pi m}{a}\right)^2, \quad \mu_n = \left(\frac{\pi n}{b}\right)^2 \quad (7)$$

Therefore

$$Z_{mn}(z) = A_{mn} \cosh(\omega_{mn} z) + B_{mn} \sinh(\omega_{mn} z), \quad (6.6.16)$$

$$\omega_{mn} = \pi \left( \frac{m^2}{a^2} + \frac{n^2}{b^2} \right)^{\frac{1}{2}}. \quad (6.6.17)$$

Finally,

$$u_{mn}(x, y, t) = \left( A_{mn} \cosh(\omega_{mn} z) + B_{mn} \sinh(\omega_{mn} z) \right) \sin\left(\frac{\pi m x}{a}\right) \sin\left(\frac{\pi n y}{b}\right) \quad (6.6.18)$$

and the general solution is derived in the form of multidimensional Fourier series (see Appendix 4.B)

$$u(x, y, t) = \sum_{m=1}^{\infty} \sum_{n=1}^{\infty} \left( A_{mn} \cosh(\omega_{mn} z) + B_{mn} \sinh(\omega_{mn} z) \right) \sin\left(\frac{\pi m x}{a}\right) \sin\left(\frac{\pi n y}{b}\right). \quad (6.6.19)$$

One can find coefficients from boundary conditions  $u|_{z=0} = g(x, y)$  and  $u|_{z=c} = h(x, y)$ .

*Remark 6.6.3.* (a) The same arguments work in higher dimensions.

(b) The same arguments work for Neumann and Robin boundary conditions and on each face of  $\Gamma$  could be its own boundary condition.

(c) Later we consider separation of variables for 2D-wave equation in the polar coordinates.

(d) Later we consider separation of variables for 3D-wave and Laplace equations in the cylindrical and spherical coordinates.

## Appendix 6.A. Linear second order ODEs

### Introduction

This is not a required reading but at some moment you would like to see how problems we discuss here for PDEs are solved for ODEs (consider it as a toy-model). We consider ODE

$$Ly := y'' + a_1(x)y' + a_2(x)y = f(x). \quad (6.A.1)$$

Let  $\{y_1(x), y_2(x)\}$  be a fundamental system of solutions of the corresponding homogeneous equation

$$Ly := y'' + a_1(x)y' + a_2(x)y = 0. \quad (6.A.2)$$

Recall that then Wronskian

$$W(y_1, y_2; x) := \begin{vmatrix} y_1(x) & y_2(x) \\ y_1'(x) & y_2'(x) \end{vmatrix} \quad (6.A.3)$$

does not vanish.

### Cauchy problem (a.k.a. IVP)

Consider equation (6.A.1) with the initial conditions

$$y(x_0) = b_1, \quad y'(x_0) = b_2. \quad (6.A.4)$$

Without any loss of the generality one can assume that

$$\begin{aligned} y_1(x_0) &= 1, & y_1'(x_0) &= 0, \\ y_2(x_0) &= 0, & y_2'(x_0) &= 1. \end{aligned} \quad (6.A.5)$$

Indeed, replacing  $\{y_1(x), y_2(x)\}$  by  $\{z_1(x), z_2(x)\}$  with  $z_j = \alpha_{j1}y_1 + \alpha_{j2}y_2$  we reach (6.A.5) by solving the systems

$$\begin{aligned} \alpha_{11}y_1(x_0) + \alpha_{12}y_2(x_0) &= 1, & \alpha_{21}y_1(x_0) + \alpha_{22}y_2(x_0) &= 0 \\ \alpha_{11}y_1'(x_0) + \alpha_{12}y_2'(x_0) &= 0, & \alpha_{21}y_1'(x_0) + \alpha_{22}y_2'(x_0) &= 1 \end{aligned}$$

which have unique solutions because  $W(y_1, y_2; x_0) \neq 0$ .



Then the general solution to the homogeneous equation (6.A.2) is  $y = C_1y_1 + C_2y_2$  with constants  $C_1, C_2$ . To find the general solution to the inhomogeneous equation (6.A.1) we apply method of variations of parameters; then

$$\begin{cases} C_1'y_1 + C_2'y_2 = 0, \\ C_1'y_1' + C_2'y_2' = f(x) \end{cases} \quad (6.A.6)$$

and then

$$C_1' = -\frac{1}{W}y_2f, \quad C_2' = \frac{1}{W}y_1f \quad (6.A.7)$$

and

$$\begin{cases} C_1(x) = -\int_{x_0}^x \frac{1}{W(x')}y_2(x')f(x') dx' + c_1, \\ C_2(x) = \int_{x_0}^x \frac{1}{W(x')}y_1(x')f(x') dx' + c_2 \end{cases} \quad (6.A.8)$$

and

$$y(x) = \int_{x_0}^x G(x; x')f(x') dx' + b_1y_1(x) + b_2y_2(x) \quad (6.A.9)$$

with

$$G(x; x') = \frac{1}{W(x')} (y_2(x)y_1(x') - y_1(x)y_2(x')) \quad (6.A.10)$$

and  $c_1 = b_1, c_2 = b_2$  found from initial data.

**Definition 6.A.1.**  $G(x, x')$  is a *Green's function* (called in the case of IVP also *Cauchy's function*).

This formula (6.A.9) could be rewritten as

$$y(x) = \int_{x_0}^x G(x; x')f(x') dx' + G'_x(x; x_0)b_1 + G(x; x_0)b_2. \quad (6.A.11)$$

## BVP

Consider inhomogeneous equation (6.A.1) with the boundary conditions

$$y(x_1) = b_1, \quad y(x_2) = b_2 \quad (6.A.12)$$

where  $x_1 < x_2$  are the ends of the segment  $[x_1, x_2]$ .

Consider first homogeneous equation (6.A.2); then  $y = c_1y_1 + c_2y_2$  and (6.A.12) becomes

$$\begin{aligned}c_1y_1(x_1) + c_2y_2(x_1) &= b_1, \\c_1y_1(x_2) + c_2y_2(x_2) &= b_2\end{aligned}$$

and this system is solvable for any  $b_1, b_2$  and this solution is unique if and only if determinant is not 0:

$$\begin{vmatrix}y_1(x_1) & y_2(x_1) \\y_1(x_2) & y_2(x_2)\end{vmatrix} \neq 0. \quad (6.A.13)$$

Assume that this condition is fulfilled. Then without any loss of the generality one can assume that

$$y_1(x_1) = 1, \quad y_1(x_2) = 0, \quad y_2(x_1) = 0, \quad y_2(x_2) = 1; \quad (6.A.14)$$

otherwise as before we can replace them by their linear combinations.

Consider inhomogeneous equation. Solving it by method of variations of parameters we have again (6.A.7) but its solution we write in a form slightly different from (6.A.8)

$$\begin{cases}C_1(x) = - \int_{x_1}^x \frac{1}{W(x')} y_2(x') f(x') dx' + c_1, \\C_2(x) = - \int_x^{x_2} \frac{1}{W(x')} y_1(x') f(x') dx' + c_2.\end{cases} \quad (6.A.15)$$

Then

$$y(x) = \int_{x_1}^{x_2} G(x; x') f(x') dx' + c_1y_1(x) + c_2y_2(x) \quad (6.A.16)$$

where

$$G(x; x') = -\frac{1}{W(x')} \begin{cases}y_2(x')y_1(x) & x_1 < x' < x, \\y_1(x')y_2(x) & x < x' < x_2.\end{cases} \quad (6.A.17)$$

From boundary conditions one can check easily that  $c_1 = b_1$ ,  $c_2 = b_2$ . One can also  $y_1(x) = -G'_{x'}(x; x')|_{x'=x_1}$ ,  $y_2(x) = -G'_{x'}(x; x')|_{x'=x_2}$  and therefore

$$\begin{aligned}y(x) &= \int_{x_1}^{x_2} G(x; x') f(x') dx' \\&\quad - G'_{x'}(x; x')|_{x'=x_1} b_1 + G'_{x'}(x; x')|_{x'=x_2} b_2.\end{aligned} \quad (6.A.18)$$

**Definition 6.A.2.**  $G(x, x')$  is a *Green's function*.

## Problems to Chapter 6

*Problem 1.* In the ring  $\{(r, \theta): 1 < r \leq 2, -\pi \leq \theta < \pi\}$  find solution

$$\begin{aligned}\Delta u &= 0, \\ u_r|_{r=1} &= 0, \\ u|_{r=2} &= |\sin(\theta)|.\end{aligned}$$

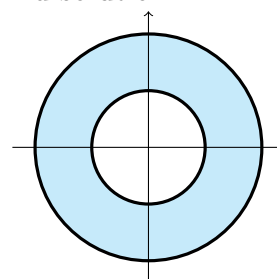

Solution should be represented in the form of the appropriate Fourier series.

*Problem 2.* In the ring  $\{(r, \theta): 1 < r \leq 2, -\pi \leq \theta < \pi\}$  find solution

$$\begin{aligned}\Delta u &= 0, \\ u|_{r=1} &= 0, \\ u|_{r=2} &= \theta^2.\end{aligned}$$

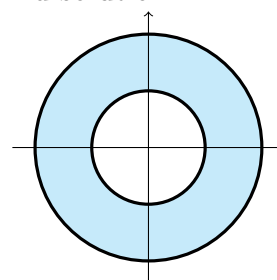

Solution should be represented in the form of the appropriate Fourier series.

*Problem 3.* In the half-disk  $\{(r, \theta): r \leq 2, 0 < \theta < \pi\}$  find solution

$$\begin{aligned}\Delta u &= 0, \\ u|_{\theta=0} &= u|_{\theta=\pi} = 0, \\ u|_{r=2} &= \theta(\pi - \theta).\end{aligned}$$

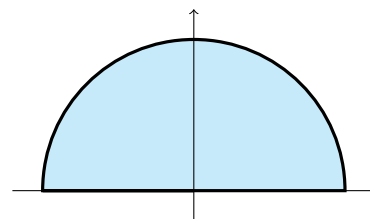

Solution should be represented in the form of the appropriate Fourier series.

*Problem 4.* In the disk exterior  $\{(r, \theta): r > 1, -\pi \leq \theta < \pi\}$  find solution

$$\begin{aligned}\Delta u &= 0, \\ u|_{r=1} &= |\theta|, \\ \max |u| &< \infty.\end{aligned}$$

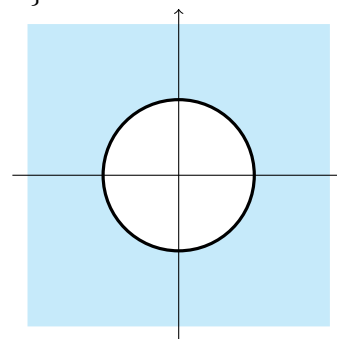

Solution should be represented in the form of the appropriate Fourier series.

*Problem 5.* In sector  $\{(r, \theta) : r < 3, |\theta| < \frac{\pi}{3}\}$  find solution by a Fourier method

$$\begin{aligned}\Delta u &= 0, \\ u_\theta|_{\theta=-\frac{\pi}{3}} &= u_\theta|_{\theta=\frac{\pi}{3}} = 0, \\ u|_{r=3} &= \theta.\end{aligned}$$

Solution should be represented in the form of the appropriate Fourier series.

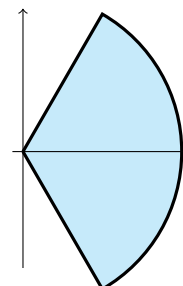

*Problem 6.* In sector  $\{(r, \theta) : r < 3, |\theta| < \frac{2\pi}{3}\}$  find solution by a Fourier method

$$\begin{aligned}\Delta u &= 0, \\ u|_{\theta=-\frac{2\pi}{3}} &= u|_{\theta=\frac{2\pi}{3}} = 0, \\ u_r|_{r=3} &= \theta.\end{aligned}$$

Solution should be represented in the form of the appropriate Fourier series.

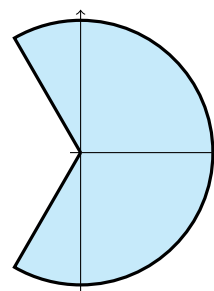

*Problem 7.* In sector  $\{(r, \theta) : r > 2, |\theta| \leq \frac{\pi}{2}\}$  find solution

$$\begin{aligned}\Delta u &= 0, \\ u|_{\theta=-\frac{\pi}{2}} &= u|_{\theta=\frac{\pi}{2}} = 0, \\ u_r|_{r=2} &= \theta^2, \\ \max |u| &< \infty.\end{aligned}$$

Solution should be represented in the form of the appropriate Fourier series.

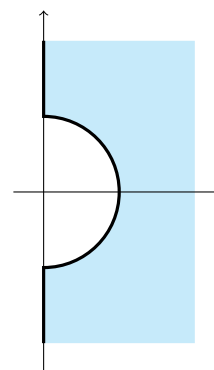

*Problem 8.* In sector  $\{(r, \theta) : r > 1, |\theta| \leq \frac{\pi}{3}\}$  find solution

$$\begin{aligned}\Delta u &= 0, \\ u_\theta|_{\theta=-\frac{\pi}{3}} &= u_\theta|_{\theta=\frac{\pi}{3}} = 0, \\ u|_{r=3} &= \theta, \\ \max |u| &< \infty.\end{aligned}$$

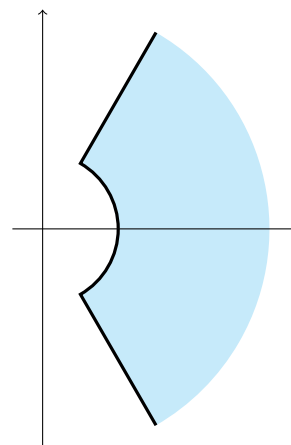

Solution should be represented in the form of the appropriate Fourier series.

*Problem 9.* Describe all real-valued solutions of biharmonic equation

$$u_{xxxx} + 2u_{xxyy} + u_{yyyy} = 0 \quad (1)$$

which one can obtain by a method of separation  $u(x, y) = X(x)Y(y)$ .

- Try to do it directly; find the term preventing us.
- However if we set  $X(x) = e^{ikx}$  (or  $X = \cos(kx)$ , or  $X(x) = \cos(kx)$ ), we will be able to get ODE for  $Y(y)$ . Solve it.
- In the rectangle  $\{0 < x < a, 0 < y < b\}$  we can find solutions,  $a$ -periodic with respect to  $x$  and satisfying boundary conditions with respect to  $y$ : at  $y = 0$  and  $\{y = b\}$  are given either  $u, u_y$ , or  $u, u_{yy}$ , or  $u_{yy}, u_{yyy}$  (conditions do not necessary match).
- Write the general solution in the form of series.

*Problem 10.* Describe all real-valued solutions of biharmonic equation

$$\Delta^2 u := (\partial_r^2 + r^{-1}\partial_r + r^{-2}\partial_\theta^2)^2 u = 0 \quad (2)$$

which one can obtain by a method of separation  $u(r, \theta) = R(r)\Theta(\theta)$ .

- Like in the previous problem, consider solution  $2\pi$ -periodic with respect to  $\theta$ , take  $\Theta(\theta) = e^{in\theta}$  and find equation to  $R(r)$ .
- Since it will be Euler equation, solve it.
- Write the general solution in the form of series.

# Chapter 7

## Laplace equation

### 7.1 General properties of Laplace equation

#### 7.1.1 Existence and uniqueness

Consider problem

$$\Delta u - cu = f \quad \text{in } \mathcal{D}, \quad (7.1.1)$$

$$u = g \quad \text{on } \Gamma_- \quad (7.1.2)$$

$$\partial_{\nu} u - \alpha u = h \quad \text{on } \Gamma_+ \quad (7.1.3)$$

where  $\mathcal{D}$  is a *connected bounded domain*,  $\Gamma$  its boundary (smooth), consisting of two non-intersecting parts  $\Gamma_-$  and  $\Gamma_+$ , and  $\nu$  a unit interior normal to  $\Gamma$ ,  $\partial_{\nu} u := \nabla u \cdot \nu$  is a normal derivative of  $u$ ,  $c$  and  $\alpha$  real valued functions.

Then

$$\begin{aligned} - \int_{\mathcal{D}} f u \, dx dy &= - \int_{\mathcal{D}} (u \Delta u - cu^2) \, dx dy \\ &= \int_{\mathcal{D}} (|\nabla u|^2 + cu^2) \, dx dy + \int_{\Gamma} u \partial_{\nu} u \, ds \\ &= \int_{\mathcal{D}} (|\nabla u|^2 + cu^2) \, dx dy + \int_{\Gamma_-} g \partial_{\nu} u \, ds + \int_{\Gamma_+} (\alpha u^2 + hu) \, ds \end{aligned}$$

where to pass from the first line to the second one we used equality  $u \Delta u = \nabla(u \cdot u) - |\nabla u|^2$  and Gauss formula, and to pass to the third line we used

$u = g$  on  $\Gamma_-$  and  $\partial_\nu u = \alpha u + h$  on  $\Gamma_+$ . Therefore assuming that

$$c \geq 0, \quad \alpha \geq 0 \quad (7.1.4)$$

we conclude that  $f = g = h = 0 \implies \nabla u = 0$  and then  $u = \text{const}$  and unless

$$c \equiv 0, \quad \alpha \equiv 0, \quad \Gamma_- = \emptyset \quad (7.1.5)$$

we conclude that  $u = 0$ .

So, if (7.1.4) is fulfilled but (7.1.5) fails problem (7.1.1)–(7.1.3) has no more than one solution (explain why). One can prove that the solution exists (sorry, we do not have analytic tools for this).

**Theorem 7.1.1.** *If (7.1.4) is fulfilled (that is  $c \geq 0, \alpha \geq 0$ ) but (7.1.5) fails, problem (7.1.1)–(7.1.3) is uniquely solvable.*

Assume now that (7.1.5) is fulfilled. Then  $u = C$  is a solution with  $f = h = 0$ . So, problem has no more than one solution modulo constant. Also

$$\int_{\mathcal{D}} f \, dx dy = \int_{\mathcal{D}} \Delta u \, dx dy = - \int_{\Gamma} \partial_\nu u \, ds$$

and therefore solution of

$$\Delta u = f \quad \text{in } \mathcal{D}, \quad (7.1.6)$$

$$\partial_\nu u = h \quad \text{on } \Gamma \quad (7.1.7)$$

does not exist unless

$$\int_{\mathcal{D}} f \, dx dy + \int_{\Gamma} h \, ds = 0. \quad (7.1.8)$$

One can prove that under assumption (7.1.8) the solution exists (sorry, we do not have analytic tools for this).

**Theorem 7.1.2.** *(i) Let (eq-7.1.5) be fulfilled. Then problem (7.1.6)–(7.1.7) has a solution iff (7.1.8) is fulfilled and this solution is unique modulo constant.*

*(ii) This solution is unique under an extra condition*

$$\int_{\mathcal{D}} u \, dx = 0. \quad (7.1.9)$$

*Remark 7.1.1.* Sure, these arguments and results hold in any dimension.

## 7.2 Potential theory and around

### 7.2.1 Gauss formula and its applications

Consider Gauss formula

$$\int_{\Omega} \nabla \cdot \mathbf{U} \, dV = - \int_{\Sigma} \mathbf{U} \cdot \boldsymbol{\nu} \, dS \quad (7.2.1)$$

where  $\Omega$  is a bounded domain with the boundary  $\Sigma$ ,  $dV$  is a volume element,  $dS$  is an area element,  $\boldsymbol{\nu}$  is a unit interior normal to  $\Sigma$ ,  $\mathbf{U}$  is a vector field and  $\nabla \cdot \mathbf{U}$  its divergence.

*Remark 7.2.1.* Usually  $\boldsymbol{\nu}$  would denote an exterior normal and then there would be no sign  $-$  on the right of (7.2.1). However, since in PDE we consider functions in the domain,  $\boldsymbol{\nu}$  denotes an *interior normal* and Gauss formula is modified correspondingly.

Let us plug  $\mathbf{U} = \nabla u$  into (7.2.1). We get

$$\int_{\Omega} \Delta u \, dV = - \int_{\Sigma} \frac{\partial u}{\partial \boldsymbol{\nu}} \, dS \quad (7.2.2)$$

where  $\Delta u = \nabla \cdot \nabla u$  is Laplacian of  $u$ ,  $\frac{\partial u}{\partial \boldsymbol{\nu}} = \nabla u \cdot \boldsymbol{\nu}$  is a derivative of  $u$  in direction  $\boldsymbol{\nu}$ .

Let us plug  $\mathbf{U} = w \nabla u$  into (7.2.1). We get

$$\int_{\Omega} (w \Delta u + \nabla u \cdot \nabla w) \, dV = - \int_{\Sigma} w \nabla u \cdot \boldsymbol{\nu} \, dS. \quad (7.2.3)$$

Antisymmetrizing (7.2.3) by  $u, w$  (permuting  $u, w$  and subtracting from original formula) we get

$$\int_{\Omega} (w \Delta u - u \Delta w) \, dV = \int_{\Sigma} \left( u \frac{\partial w}{\partial \boldsymbol{\nu}} - w \frac{\partial u}{\partial \boldsymbol{\nu}} \right) \, dS. \quad (7.2.4)$$

Consider now point  $\mathbf{y}$  not on  $\Sigma$  and a function  $w = |\mathbf{x} - \mathbf{y}|^{2-n}$  where  $n$  is a dimension (as  $n = 2$  we take  $w = -\ln |\mathbf{x} - \mathbf{y}|$ ). If  $\mathbf{y} \in \Omega$  we cannot plug it in our formulae as  $w$  is singular at  $\mathbf{x} = \mathbf{y}$ . So we consider  $B_{\epsilon}$  ball of small radius  $\epsilon$  with a center  $\mathbf{y}$ ,  $\Omega_{\epsilon} = \Omega \setminus B_{\epsilon}$  domain  $\Omega$  with removed  $B_{\epsilon}$  and



$\Sigma_\epsilon = \Sigma \cup S_\epsilon$  its boundary, where  $S_\epsilon$  is the sphere of radius  $\epsilon$  with a center  $\mathbf{y}$ . We get

$$\int_{\Omega_\epsilon} (w\Delta u - u\Delta w) dV = \int_{\Sigma} \left( u \frac{\partial w}{\partial \boldsymbol{\nu}} - w \frac{\partial u}{\partial \boldsymbol{\nu}} \right) dS + \int_{S_\epsilon} \left( u \frac{\partial w}{\partial \boldsymbol{\nu}} - w \frac{\partial u}{\partial \boldsymbol{\nu}} \right) dS. \quad (7.2.5)$$

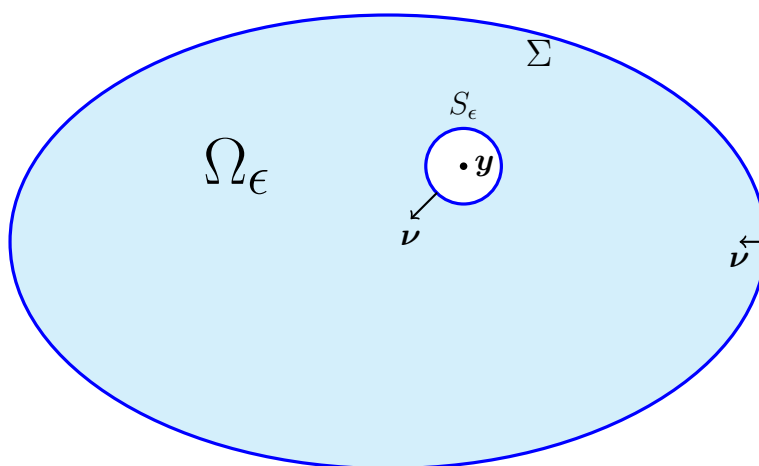

Let us consider the last term in (7.2.5) as  $\epsilon \rightarrow 0$ :

$$\int_{S_\epsilon} \left( u \frac{\partial w}{\partial \boldsymbol{\nu}} - w \frac{\partial u}{\partial \boldsymbol{\nu}} \right) dS.$$

Note that  $w = \epsilon^{2-n}$  on  $S_\epsilon$  and therefore  $|\int_{S_\epsilon} w \frac{\partial u}{\partial \boldsymbol{\nu}} dS|$  does not exceed  $C\epsilon^{n-1} \times \epsilon^{2-n} = C\epsilon$  so it tends to 0. We used that the area of  $S_\epsilon$  is  $\sigma_n \epsilon^{n-1}$  (where  $\sigma_2 = 2\pi$ ,  $\sigma_3 = 4\pi$ ).

For  $\int_{S_\epsilon} u \frac{\partial w}{\partial \boldsymbol{\nu}} dS$  we need more sophisticated arguments because  $\frac{\partial w}{\partial \boldsymbol{\nu}} = (n-2)\epsilon^{1-n}$  on  $S_\epsilon$  (really, here  $\boldsymbol{\nu}$  is a radial direction away from  $\mathbf{y}$ ; as  $n=2$  we get  $-\epsilon^{-1}$ ). Consider

$$\int_{S_\epsilon} u \frac{\partial w}{\partial \boldsymbol{\nu}} dS = \int_{S_\epsilon} (u(\mathbf{x}) - u(\mathbf{y})) \frac{\partial w}{\partial \boldsymbol{\nu}} dS + u(\mathbf{y}) \int_{S_\epsilon} \frac{\partial w}{\partial \boldsymbol{\nu}} dS \quad (7.2.6)$$

(old trick to add and subtract a constant). An absolute value of the first term does not exceed  $C \max_{\mathbf{x} \in S_\epsilon} |u(\mathbf{x}) - u(\mathbf{y})| \rightarrow 0$  as  $\epsilon \rightarrow 0$ . The second term just equals  $(n-2)\sigma_n u(\mathbf{y})$ .

*Exercise 7.2.1.* Prove that  $\Delta w = 0$  as  $\mathbf{x} \neq \mathbf{y}$ .

Therefore

$$\int_{\Omega_\epsilon} (w\Delta u - u\Delta w) dV = \int_{\Sigma} \left( u \frac{\partial w}{\partial \boldsymbol{\nu}} - w \frac{\partial u}{\partial \boldsymbol{\nu}} \right) dS + \int_{S_\epsilon} \left( u \frac{\partial w}{\partial \boldsymbol{\nu}} - w \frac{\partial u}{\partial \boldsymbol{\nu}} \right) dS. \quad (7.2.5)$$

becomes

$$\int_{\Omega} w\Delta u dV = \int_{\Sigma} \left( u \frac{\partial w}{\partial \boldsymbol{\nu}} - w \frac{\partial u}{\partial \boldsymbol{\nu}} \right) dS + (n-2)\sigma_n u(\mathbf{y})$$

where the term on the left is a usual improper integral and we have proven

**Theorem 7.2.1.** *Let  $\Omega$  be a bounded domain with a boundary  $\Sigma$ , and  $\mathbf{y} \in \Omega$  (and in particular,  $\mathbf{y} \notin \Sigma$ ). Then*

$$u(\mathbf{y}) = \int_{\Omega} G(\mathbf{x}, \mathbf{y}) \Delta u(\mathbf{x}) dV + \int_{\Sigma} \left( -u(\mathbf{x}) \frac{\partial G}{\partial \boldsymbol{\nu}_x}(\mathbf{x}, \mathbf{y}) + G(\mathbf{x}, \mathbf{y}) \frac{\partial u}{\partial \boldsymbol{\nu}}(\mathbf{x}) \right) dS \quad (7.2.7)$$

with

$$G(\mathbf{x}, \mathbf{y}) = \begin{cases} -\frac{1}{(n-2)\sigma_n} |\mathbf{x} - \mathbf{y}|^{2-n} & n \neq 2, \\ -\frac{1}{4\pi} |\mathbf{x} - \mathbf{y}|^{-1} & n = 3, \\ \frac{1}{2\pi} \ln |\mathbf{x} - \mathbf{y}| & n = 2, \\ \frac{1}{2} |x - y| & n = 1. \end{cases} \quad (7.2.8)$$

## 7.2.2 Potential

**Definition 7.2.1.**  $G(\mathbf{x}, \mathbf{y})$  is a *potential*. In particular, as  $n = 3$  we get a *Coulomb potential* (a.k.a. *Newton potential*), and as  $n = 2$  we get a *logarithmic potential*.

Therefore if we know that  $\Delta u = f$  in  $\Omega$ ,  $u|_{\Sigma} = g$  and  $\frac{\partial u}{\partial \nu} = h$  (which is *overdetermined problem* since only one boundary condition is in fact needed) we get

$$\begin{aligned} u(\mathbf{y}) &= \int_{\Omega} G(\mathbf{x}, \mathbf{y}) f(\mathbf{x}) dV \\ &+ \int_{\Sigma} G(\mathbf{x}, \mathbf{y}) h(\mathbf{x}) dS \\ &- \int_{\Sigma} \frac{\partial G}{\partial \nu_x}(\mathbf{x}, \mathbf{y}) g(\mathbf{x}) dS. \end{aligned} \quad (7.2.9)$$

**Definition 7.2.2.** (a) The first term in the right-hand expression is a potential created by a charge with density  $f$ ,

(b) The second term in the right-hand expression is a potential created by a charge with surface density  $h$  (a.k.a. a *single layer potential*),

(c) The third term in the right-hand expression is a *double layer potential*.

*Remark 7.2.2.* In fact we can consider two surfaces  $\Sigma^- = \Sigma$  and  $\Sigma^+$  on the distance exactly  $\varepsilon$  from  $\Sigma$  on its “outer” side and density  $-\varepsilon^{-1}g$  on  $\Sigma^-$  and  $\varepsilon g$  on  $\Sigma^+$  (we can extend  $g$  and as long as this extension is smooth it does not matter how), consider corresponding single layer potential, and then tend  $\varepsilon \rightarrow +0$ .

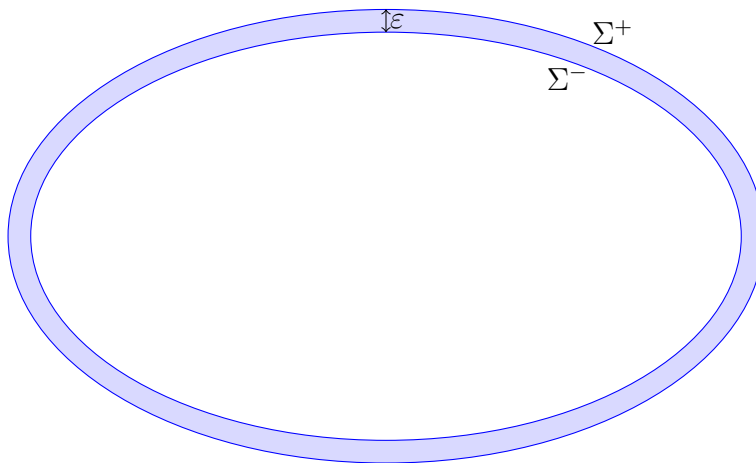

*Remark 7.2.3.* It is known that volume on  $n$ -dimensional ball is

$$\omega_n = \begin{cases} \frac{\pi^{n/2}}{(n/2)!} & \text{for even } n, \\ \frac{2^{(n+1)/2} \pi^{(n-1)/2}}{n!!} & \text{for odd } n, \end{cases}$$

where  $m!! = m(m-2)(m-4)\cdots$  (the last factor 2 or 1 for even and odd  $m$ ) and  $\sigma_n = n\omega_n$ .

**Theorem 7.2.2.** *Harmonic function is infinitely smooth.*

*Proof.* From (7.2.9) if  $\Delta u = 0$  we have

$$u(\mathbf{y}) = \int_{\Sigma} G(\mathbf{x}, \mathbf{y}) h(\mathbf{x}) dS - \int_{\Sigma} \frac{\partial G}{\partial \nu_x}(\mathbf{x}, \mathbf{y}) g(\mathbf{x}) dS.$$

and since  $G(\mathbf{x}, \mathbf{y})$  is infinitely smooth as  $\mathbf{x} \neq \mathbf{y}$  we conclude that  $u$  is infinitely smooth.  $\square$

*Remark 7.2.4.* (a) Actually  $u$  is *real-analytic* in  $\Omega$ .

(b) Actually if  $\Delta u$  is infinitely smooth (or real-analytic) in  $\Omega$  then  $u$  is also infinitely smooth (or real-analytic) in  $\Omega$ .

### 7.2.3 Laplace equation in $\mathbb{R}^n$

This formula (7.2.9) as we expand  $\Omega$  to the whole space  $\mathbb{R}^n$  becomes

**Theorem 7.2.3.** *Let  $n \geq 3$ . If  $f$  decays fast enough at infinity then*

$$u(\mathbf{y}) = \int_{\mathbb{R}^n} G(\mathbf{x}, \mathbf{y}) \Delta u(\mathbf{x}) dV \quad (7.2.10)$$

*solves equation*

$$\Delta u = f \quad (7.2.11)$$

*with conditions at infinity*

$$u = O(r^{2-n}), \quad (7.2.12)$$

$$\partial_r u = O(r^{1-n}) \quad \text{as } r = |\mathbf{x}| \rightarrow \infty. \quad (7.2.13)$$

### 7.2.4 Mean-value theorem

Consider  $\Omega$  a ball of radius  $r$  with a center in  $\mathbf{y}$ . Let  $u$  be a harmonic function (i.e.  $\Delta u = 0$ ) in  $\Omega$ . Then

- (a) The first term in the right-hand expression of

$$u(\mathbf{y}) = \int_{\Omega} G(\mathbf{x}, \mathbf{y}) \Delta u(\mathbf{x}) dV + \int_{\Sigma} \left( -u(\mathbf{x}) \frac{\partial G}{\partial \nu_x}(\mathbf{x}, \mathbf{y}) + G(\mathbf{x}, \mathbf{y}) \frac{\partial u}{\partial \nu}(\mathbf{x}) \right) dS \quad (7)$$

is 0.

- (b) Breaking the second term of (7.2.7) into

$$- \int_{\Sigma} u(\mathbf{x}) \frac{\partial G}{\partial \nu_x}(\mathbf{x}, \mathbf{y}) dS + \int_{\Sigma} G(\mathbf{x}, \mathbf{y}) \frac{\partial u}{\partial \nu}(\mathbf{x}) dS$$

in the second part we can drag factor  $G(\mathbf{x}, \mathbf{y})$  (since  $\Sigma$  is a sphere of radius  $r$  centered at  $\mathbf{y}$  it is constant there) out of integral where remains  $\int_{\Sigma} \frac{\partial u}{\partial \nu} dS = - \int_V \Delta u dV = 0$ .

- (c) Similarly, in the first part

$$- \int_{\Sigma} u(\mathbf{x}) \frac{\partial G}{\partial \nu_x}(\mathbf{x}, \mathbf{y}) dS$$

we can drag factor  $\frac{\partial G}{\partial \nu_x}$  out of integral where remains  $\int_{\Sigma} u dS$  and we get

$$u(\mathbf{y}) = \frac{1}{\sigma_n r^{n-1}} \int_{\Sigma} u(\mathbf{x}) dS. \quad (7.2.14)$$

So we proved Statement (i) of

**Theorem 7.2.4.** (i) If  $u$  is harmonic in the ball  $B(\mathbf{y}, r)$  of radius  $r$  then in its center  $\mathbf{y}$  the value of  $u$  is a mean value of  $u$  over the sphere  $S(\mathbf{y}, r)$  bounding this ball.

- (ii) If  $u$  is harmonic in the ball  $B(\mathbf{y}, r)$  of radius  $r$  then in its center the value of  $u$  is a mean value of  $u$  over this ball.

*Proof.* To prove Statement (ii) one should note from Statement (i) that  $\int_{S(\mathbf{y},\rho)} u(\mathbf{x}) dS = \sigma_n \rho^{n-1} u(\mathbf{y})$  for any  $\rho \in (0, r)$  and then

$$\int_{B(\mathbf{y},r)} u(\mathbf{x}) dx = \int_0^r \left( \int_{S(\mathbf{y},\rho)} u(\mathbf{x}) dS \right) d\rho = u(\mathbf{y}) \times \sigma_n \int_0^r \rho^{n-1} d\rho$$

and that  $\sigma_n \int_0^r \rho^{n-1} d\rho$  is a volume of  $B(\mathbf{y}, r)$ . □

### 7.2.5 Maximum and minimum principle

**Theorem 7.2.5.** *Let  $u$  be a harmonic function in the bounded domain  $\Omega$  with a boundary  $\Sigma$ . Then*

- (i)  $\max_{\Omega} u = \max_{\Sigma} u$  and  $\min_{\Omega} u = \min_{\Sigma} u$ ;
- (ii) *If  $\Omega$  is connected and  $u(\mathbf{y}) = \max_{\Omega} u$  (or  $u(\mathbf{y}) = \min_{\Omega} u$ ) for some inner point  $\mathbf{y}$  then  $u = \text{const}$ .*

*Proof.* Assume that  $u(\mathbf{y}) = \max_{\Omega} u$  for some inner point  $\mathbf{y}$ . Consider the largest ball  $B(\mathbf{y}, r)$  contained in  $\Omega$ . By mean-value theorem  $u(\mathbf{y})$  is a mean-value of  $u$  over this ball but it is also a maximal value of  $u$  in this ball and therefore  $u(\mathbf{x}) = u(\mathbf{y})$  in this ball.

Then any point on  $S(\mathbf{y}, r)$  could be used as a “new  $\mathbf{y}$ ” and we can continue. Eventually each point of  $\mathbf{x}$  which could be connected to  $\mathbf{y}$  by a continuous curve inside of  $\Omega$  will be covered and then in this point  $u(\mathbf{x}) = u(\mathbf{y})$ . So, in the connected component of  $\Omega$  containing  $\mathbf{y}$ ,  $u = u(\mathbf{y})$  and it will be true on its border. Then  $\max_{\Sigma} u \geq u(\mathbf{y}) = \max_{\Omega} u$ ; but  $\max_{\Omega} u \geq \max_{\Sigma} u$  and therefore Statement (i) has been proven.

It also proves Statement (ii) as now we assume that  $\Omega$  is connected. □

### 7.2.6 Uniqueness for Dirichlet problem

**Theorem 7.2.6.** (i) *Let  $\Omega$  be a bounded domain. Then solution of Dirichlet problem in  $\Omega$  for Laplace equation is unique.*

- (ii) *Let  $\Omega$  be an unbounded domain. Then solution of Dirichlet problem in  $\Omega$  for Laplace equation is unique under condition at infinity:  $|u| \rightarrow 0$  as  $|\mathbf{x}| \rightarrow \infty$ .*

*Proof.* Consider  $u$  solving  $\Delta u = 0$ ,  $u|_{\Sigma} = 0$  (and satisfying condition at infinity in (ii)).

(i) Due to maximum and minimum principle

$$0 = \min_{\Sigma} u \leq u(\mathbf{y}) \leq \max_{\Sigma} u = 0 \quad \text{for } \mathbf{y} \in \Omega.$$

(ii) Consider ball  $B(0, R)$  and domain  $\Omega_R = \Omega \cap B(0, R)$ . Its boundary is  $\Sigma_R := (\Sigma \cap B(0, R)) \cup (\Omega \cap S(0, R))$ . Then as  $R \geq |\mathbf{y}|$

$$\min_{\Sigma_R} u \leq u(\mathbf{y}) \leq \max_{\Sigma_R} u$$

but

$$\min_{\Sigma_R} u = \min\left(\min_{\Sigma \cap B(0, R)} u, \min_{\Omega \cap S(0, R)} u\right) \quad (7.2.15)$$

if  $\Sigma \cap B(0, R) \neq \emptyset$ , otherwise we get just  $\min_{\Omega \cap S(0, R)} u$ . However  $\min_{\Omega \cap S(0, R)} u \rightarrow 0$  as  $R \rightarrow \infty$  due to condition to infinity.

Also  $\min_{\Sigma \cap B(0, R)} u = 0$  and therefore the left-hand expression in (7.2.15) tends to 0 as  $R \rightarrow \infty$ .

Similarly the right-hand expression in (7.2.15) tends to 0 as  $R \rightarrow \infty$  and we have  $0 \leq u(\mathbf{y}) \leq 0$ . □

## 7.3 Green's function

### 7.3.1 Newton shell theorem

Let  $n \geq 3$ . Consider spherically symmetric density  $f$  (thus depending on  $r = (x_1^2 + x_2^2 + \dots + x_n^2)^{\frac{1}{2}}$  only). Then it creates a potential which is also spherically symmetric.

Assume first that  $f = 0$  in  $B(0, R)$  and consider  $u$  in  $B(0, R)$ . Here  $u$  must be harmonic and then due to mean-value theorem  $u = u(0)$  is constant (in particular  $\nabla u = 0$ ). More precisely

$$u = -\frac{1}{n-2} \int_R^{\infty} r f(r) dr \quad (7.3.1)$$

where we replaced lower limit 0 by  $R$  since  $f(r) = 0$  as  $r < R$ .

Assume now that  $f = 0$  in  $\{r \geq R\}$  and consider  $u$  there. Then  $u = r^{2-n}A + B$ .

*Exercise 7.3.1.* Prove that if  $f$  is spherically symmetric and  $f = 0$  in  $\{r \geq R\}$  then  $u = r^{2-n}A + B$  there.

To have potential at infinity equal to 0 we must take  $B = 0$ . Further, plug it into (7.2.2) with  $\Omega = B(0, R)$ :

$$\int_{\Omega} \Delta u \, dV = - \int_{\Sigma} \frac{\partial u}{\partial \nu} \, dS \quad (7.2.2)$$

The left-hand expression becomes the total charge  $\int_{B(0,R)} f(\mathbf{x}) \, dV$  while the right-hand expression becomes  $-(n-2)\sigma_n A$  and therefore

$$u = -\frac{1}{(n-2)\sigma_n} r^{2-n} \int_{B(0,R)} f \, dx = -\frac{1}{n-2} r^{2-n} \int_0^R r^{n-1} f(r) \, dr. \quad (7.3.2)$$

Then in the general case we to calculate  $u$  we break  $f = f_1 + f_2$  where  $f_1 = 0$  for  $r \geq R$  and  $f_2 = 0$  for  $r \leq R$  and then calculate  $u$  as  $r = R$  and finally set  $R = r$ :

$$u = -\frac{1}{n-2} \int_r^{\infty} r f(r) \, dr - \frac{1}{n-2} r^{2-n} \int_0^r r^{n-1} f(r) \, dr. \quad (7.3.3)$$

In particular,

**Theorem 7.3.1.** *Let  $f$  be spherically symmetric. Then*

- (i) *Let  $f = 0$  as  $r \geq R$ . Then  $u$  coincides as  $r \geq R$  with a potential created by the same mass but concentrated in the origin.*
- (ii) *Let  $f = 0$  as  $r \leq R$ . Then  $u = \text{const}$  as  $r \leq R$ . If  $f = 0$  as  $r \leq R$  then  $u = \text{const}$  there.*

*Remark 7.3.1.* Statement (ii) is often expressed by a catch phrase *There is no gravity in the cavity.*

In particular if  $f(r) = \text{const}$  as  $R_1 \leq r \leq R_2$  and  $f(r) = 0$  as  $r \leq R_1$  or  $r \geq R_2$ , then all calculations are easy. Amazingly, the same is true for a shell between two proportional ellipsoids (Ivory theorem).



### 7.3.2 Green's function. I

Recall (7.2.7)–(7.2.8)

$$u(\mathbf{y}) = \int_{\Omega} G^0(\mathbf{x}, \mathbf{y}) \Delta u(\mathbf{x}) dV + \int_{\Sigma} \left( -u(\mathbf{x}) \frac{\partial G^0}{\partial \nu_x}(\mathbf{x}, \mathbf{y}) + G^0(\mathbf{x}, \mathbf{y}) \frac{\partial u}{\partial \nu}(\mathbf{x}) \right) dS \quad (7.2.7)$$

with

$$G^0(\mathbf{x}, \mathbf{y}) = \begin{cases} -\frac{1}{(n-2)\sigma_n} |\mathbf{x} - \mathbf{y}|^{2-n} & n \neq 2, \\ -\frac{1}{4\pi} |\mathbf{x} - \mathbf{y}|^{-1} & n = 3, \\ \frac{1}{2\pi} \log |\mathbf{x} - \mathbf{y}| & n = 2, \\ \frac{1}{2} |x - y| & n = 1 \end{cases} \quad (7.2.8)$$

where we changed notation  $G^0$  instead of  $G$  as we will redefine  $G$  later.

Let  $g(\mathbf{x}, \mathbf{y})$  be solution to problem

$$\Delta_x g(\mathbf{x}, \mathbf{y}) = 0 \quad \text{in } \Omega, \quad (7.3.4)$$

$$g(\mathbf{x}, \mathbf{y}) = -G^0(\mathbf{x}, \mathbf{y}) \quad \text{as } \mathbf{x} \in \Sigma \quad (7.3.5)$$

and condition  $g(\mathbf{x}, \mathbf{y}) \rightarrow 0$  as  $|\mathbf{x}| \rightarrow \infty$  if  $\Omega$  is unbounded. In virtue of (7.3.4) and (7.2.5)

$$\int_{\Omega_\epsilon} (w \Delta u - u \Delta w) dV = \int_{\Sigma} \left( u \frac{\partial w}{\partial \nu} - w \frac{\partial u}{\partial \nu} \right) dS + \int_{S_\epsilon} \left( u \frac{\partial w}{\partial \nu} - w \frac{\partial u}{\partial \nu} \right) dS \quad (7.2.5)$$

we have

$$0 = \int_{\Omega} g(\mathbf{x}, \mathbf{y}) \Delta u(\mathbf{x}) dV + \int_{\Sigma} \left( -u(\mathbf{x}) \frac{\partial g}{\partial \nu_x}(\mathbf{x}, \mathbf{y}) + g(\mathbf{x}, \mathbf{y}) \frac{\partial u}{\partial \nu}(\mathbf{x}) \right) dS. \quad (7.3.6)$$

Adding to (7.2.7) we get

$$u(\mathbf{y}) = \int_{\Omega} G(\mathbf{x}, \mathbf{y}) \Delta u(\mathbf{x}) dV + \int_{\Sigma} \left( -u(\mathbf{x}) \frac{\partial G}{\partial \boldsymbol{\nu}_x}(\mathbf{x}, \mathbf{y}) + G(\mathbf{x}, \mathbf{y}) \frac{\partial u}{\partial \boldsymbol{\nu}}(\mathbf{x}) \right) dS \quad (7.3.7)$$

with

$$G(\mathbf{x}, \mathbf{y}) := G^0(\mathbf{x}, \mathbf{y}) + g(\mathbf{x}, \mathbf{y}). \quad (7.3.8)$$

So far we have not used (7.3.5) which is equivalent to  $G(\mathbf{x}, \mathbf{y}) = 0$  as  $\mathbf{x} \in \Sigma$ . But then

$$u(\mathbf{y}) = \int_{\Omega} G(\mathbf{x}, \mathbf{y}) \Delta u(\mathbf{x}) dV - \int_{\Sigma} \frac{\partial G}{\partial \boldsymbol{\nu}_x}(\mathbf{x}, \mathbf{y}) u(\mathbf{x}) dS$$

and therefore

$$u(\mathbf{y}) = \int_{\Omega} G(\mathbf{x}, \mathbf{y}) f(\mathbf{x}) dV - \int_{\Sigma} \frac{\partial G}{\partial \boldsymbol{\nu}_x}(\mathbf{x}, \mathbf{y}) \phi(\mathbf{x}) dS \quad (7.3.9)$$

is a solution to

$$\Delta u = f \quad \text{in } \Omega, \quad (7.3.10)$$

$$u = \phi \quad \text{on } \Sigma. \quad (7.3.11)$$

Similarly if we replace (7.3.5) by Robin boundary condition

$$\left[ \frac{\partial g}{\partial \boldsymbol{\nu}_x} - \alpha g \right](\mathbf{x}, \mathbf{y}) = - \left[ \frac{\partial G^0}{\partial \boldsymbol{\nu}_x} - \alpha G^0 \right](\mathbf{x}, \mathbf{y}) \quad \text{as } \mathbf{x} \in \Sigma \quad (7.3.12)$$

we get

$$\left[ \frac{\partial G}{\partial \boldsymbol{\nu}_x} - \alpha G \right](\mathbf{x}, \mathbf{y}) = 0 \quad \text{as } \mathbf{x} \in \Sigma$$

and rewriting (7.3.7) as

$$u(\mathbf{y}) = \int_{\Omega} G(\mathbf{x}, \mathbf{y}) \Delta u(\mathbf{x}) dV + \int_{\Sigma} \left( -u(\mathbf{x}) \left[ \frac{\partial G}{\partial \boldsymbol{\nu}_x} - \alpha G \right](\mathbf{x}, \mathbf{y}) + G(\mathbf{x}, \mathbf{y}) \left[ \frac{\partial u}{\partial \boldsymbol{\nu}} - \alpha u \right] \right) dS \quad (7.3.13)$$

we get

$$u(\mathbf{y}) = \int_{\Omega} G(\mathbf{x}, \mathbf{y}) f(\mathbf{x}) dV + \int_{\Sigma} G(\mathbf{x}, \mathbf{y}) \psi(\mathbf{x}) dS \quad (7.3.14)$$

for solution of the (7.3.10) with the boundary condition

$$\frac{\partial u}{\partial \boldsymbol{\nu}} - \alpha u = \psi \quad \text{on } \Sigma. \quad (7.3.15)$$

Finally, if we take  $g$  satisfying mixed boundary condition

$$g(\mathbf{x}, \mathbf{y}) = -G^0(\mathbf{x}, \mathbf{y}) \quad \text{as } \mathbf{x} \in \Sigma', \quad (7.3.16)$$

$$\left[ \frac{\partial g}{\partial \boldsymbol{\nu}_x} - \alpha g \right](\mathbf{x}, \mathbf{y}) = - \left[ \frac{\partial G^0}{\partial \boldsymbol{\nu}_x} - \alpha G^0 \right](\mathbf{x}, \mathbf{y}) \quad \text{as } \mathbf{x} \in \Sigma'', \quad (7.3.17)$$

where  $\Sigma = \Sigma' \cup \Sigma''$  and  $\Sigma' \cap \Sigma'' = \emptyset$ , we get

$$u(\mathbf{y}) = \int_{\Omega} G(\mathbf{x}, \mathbf{y}) f(\mathbf{x}) dV + \int_{\Sigma'} G(\mathbf{x}, \mathbf{y}) \psi(\mathbf{x}) dS - \int_{\Sigma''} \frac{\partial G(\mathbf{x}, \mathbf{y})}{\partial \boldsymbol{\nu}_x} \phi(\mathbf{x}) dS \quad (7.3.18)$$

for solution of the (7.3.10) with the boundary condition

$$u = \phi \quad \text{on } \Sigma', \quad (7.3.19)$$

$$\frac{\partial u}{\partial \boldsymbol{\nu}} - \alpha u = \psi \quad \text{on } \Sigma''. \quad (7.3.20)$$

**Definition 7.3.1.**  $G(\mathbf{x}, \mathbf{y})$  (defined for corresponding boundary problem) is called *Green's function*.

*Remark 7.3.2.* It is similar (by usage) to heat kernel  $\frac{1}{2\sqrt{kt}} e^{-\frac{|\mathbf{x}-\mathbf{y}|^2}{4kt}}$ .

One can prove

**Theorem 7.3.2.**

$$G(\mathbf{x}, \mathbf{y}) = G(\mathbf{y}, \mathbf{x}). \quad (7.3.21)$$

### 7.3.3 Green's function. II

Consider now purely Neumann problem in the connected domain. We cannot solve  $\Delta g = 0$  with the boundary condition  $\frac{\partial g}{\partial \nu_x} = -\frac{\partial G^0}{\partial \nu_x}$  since such problem requires one solvability condition to the right-hand expression and boundary value

$$\int_{\Omega} f dV + \int_{\Sigma} \psi dS = 0 \quad (7.3.22)$$

and this condition fails as  $\int_{\Sigma} \frac{\partial G^0}{\partial \nu_x} dS \neq 0$  (one can prove it easily).

To fix it we consider  $g(\mathbf{x}, \mathbf{y})$  satisfying

$$\Delta_x g(\mathbf{x}, \mathbf{y}) = c \quad \text{in } \Omega, \quad (7.3.23)$$

$$\frac{\partial g}{\partial \nu_x}(\mathbf{x}, \mathbf{y}) = -\frac{\partial G^0}{\partial \nu_x}(\mathbf{x}, \mathbf{y}) \quad \text{as } \mathbf{x} \in \Sigma \quad (7.3.24)$$

with unknown constant  $c$ ; choosing it correctly one can satisfy solvability condition.

Then

$$u(\mathbf{y}) = \int_{\Omega} G(\mathbf{x}, \mathbf{y}) f(\mathbf{x}) dV + \int_{\Sigma} G(\mathbf{x}, \mathbf{y}) \psi(\mathbf{x}) dS + c \int_{V} u dV$$

and therefore

$$u(\mathbf{y}) = \int_{\Omega} G(\mathbf{x}, \mathbf{y}) f(\mathbf{x}) dV + \int_{\Sigma} G(\mathbf{x}, \mathbf{y}) \psi(\mathbf{x}) dS + C \quad (7.3.25)$$

gives us solution if it exists (and it exists under solvability condition (7.3.22)). This solution is defined up to a constant.

## Problems to Chapter 7

*Problem 1.* (a) Find the solutions that depend only on  $r$  of the equation

$$\Delta u := u_{xx} + u_{yy} = 0.$$

(b) Find the solutions that depend only on  $\rho$  of the equation

$$\Delta u := u_{xx} + u_{yy} + u_{zz} = 0.$$

- (c) In  $n$ -dimensional case prove that if  $u = u(r)$  with  $r = (x_1^2 + x_2^2 + \dots + x_n^2)^{\frac{1}{2}}$  then

$$\Delta u = u_{rr} + \frac{n-1}{r}u_r = 0. \quad (1)$$

- (d) In  $n$ -dimensional case prove ( $n \neq 2$ ) that  $u = u(r)$  satisfies Laplace equation as  $\mathbf{x} \neq 0$  iff  $u = Ar^{2-n} + B$ .

*Problem 2.* Using the proof of mean value theorem (see Subsection 7.2.4) prove that if  $\Delta u \geq 0$  in  $B(\mathbf{y}, r)$  then

- (a)  $u(\mathbf{y})$  does not exceed the mean value of  $u$  over the sphere  $S(\mathbf{y}, r)$  bounding this ball:

$$u(\mathbf{y}) \leq \frac{1}{\sigma_n r^{n-1}} \int_{S(\mathbf{y}, r)} u dS. \quad (2)$$

- (b)  $u(\mathbf{y})$  does not exceed the mean value of  $u$  over this ball  $B(\mathbf{y}, r)$ :

$$u(\mathbf{y}) \leq \frac{1}{\omega_n r^n} \int_{B(\mathbf{y}, r)} u dV. \quad (3)$$

- (c) Formulate similar statements for functions satisfying  $\Delta u \leq 0$  (in the next problem we refer to them as (a)' and (b)').

*Problem 3.* (a) Functions having property (a) (or (b) does not matter) of the previous problem are called *subharmonic*.

- (b) Functions having property (a)' (or (b)' does not matter) are called *superharmonic*.

*Problem 4.* (a) Using the proof of maximum principle prove the maximum principle for subharmonic functions and minimum principle for superharmonic functions.

- (b) Show that minimum principle for subharmonic functions and maximum principle for superharmonic functions do not hold (*Hint*: construct counterexamples with  $f = f(r)$ ).
- (c) Prove that if  $u, v, w$  are respectively harmonic, subharmonic and superharmonic functions in the bounded domain  $\Omega$ , coinciding on its boundary ( $u|_{\Sigma} = v|_{\Sigma} = w|_{\Sigma}$ ) then in  $w \geq u \geq v$  in  $\Omega$ .

*Problem 5.* Using Newton shell theorem (see Subsection 7.3.1) prove that if Earth was a homogeneous solid ball then the gravity pull inside of it would be proportional to the distance to the center.

*Problem 6.* Find function  $u$  harmonic in  $\{x^2 + y^2 + z^2 \leq 1\}$  and coinciding with  $g = z^3$  as  $x^2 + y^2 + z^2 = 1$ .

*Hint.* According to Section 8.1 solution must be a harmonic polynomial of degree 3 and it should depend only on  $x^2 + y^2 + z^2$  and  $z$  (Explain why). The only way to achieve it (and still coincide with  $g$  on  $\{x^2 + y^2 + z^2 = 1\}$ ) is to find

$$u = z^3 + az(1 - x^2 - y^2 - z^2)$$

with unknown coefficient  $A$ .

*Problem 7.* Apply method of descent described in Subsection 9.1.4 but to Laplace equation in  $\mathbb{R}^2$  and starting from Coulomb potential in  $3D$

$$U_3(x, y, z) = -\frac{1}{4\pi}(x^2 + y^2 + z^2)^{-\frac{1}{2}}, \quad (4)$$

derive logarithmic potential in  $2D$

$$U_2(x, y, z) = \frac{1}{2\pi} \log(x^2 + y^2)^{\frac{1}{2}}, \quad (5)$$

*Hint.* You will need to calculate diverging integral  $\int_0^\infty U_3(x, y, z)$ . Instead consider  $\int_0^N U_3(x, y, z)$ , subtract constant (f.e.  $\int_0^N U_3(1, 0, z)$ ) and then tend  $N \rightarrow \infty$ .

*Problem 8.* Using method of reflection (studied earlier for different equations) construct Green function for

- (a) Dirichlet problem
- (b) Neumann problem

for Laplace equation in

- a. half-plane
- b. half-space

as we know that in the whole plane and space they are just potentials

$$\frac{1}{2\pi} \log((x_1 - y_1)^2 + (x_2 - y_2)^2)^{\frac{1}{2}}, \quad (6)$$

$$-\frac{1}{4\pi} ((x_1 - y_1)^2 + (x_2 - y_2)^2 + (x_3 - y_3)^2)^{-\frac{1}{2}} \quad (7)$$

respectively.

*Problem 9.* Apply method of descent but now looking for stationary solution of  $-\Delta u = f(x_1, x_2, x_3)$  instead of non-stationary solution of

$$u_{tt} - \Delta u = f(x_1, x_2, x_3), \quad (8)$$

$$u|_{t=0} = g(x_1, x_2, x_3), \quad (9)$$

$$u_t|_{t=0} = h(x_1, x_2, x_3); \quad (10)$$

start from Kirchhoff formula (9.1.12) and derive for  $n = 3$  (7.2.10) with  $G(\mathbf{x}, \mathbf{y})$  equal to (7) here.

*Problem 10.* Check that

$$u(x, y) = \sin(y)e^{-x}$$

is a harmonic function and find

$$\max_{(x,y) \in D} u(x, y) \quad \text{and} \quad \min_{(x,y) \in D} u(x, y)$$

and points, where they are achieved where

$$D = \{(x, y) : |y| \leq x\}.$$

*Hint.* Consider a truncated region  $D_R = \{(x, y) : |y| \leq x, x^2 + y^2 \leq R^2\}$  with  $R \rightarrow \infty$ .

*Problem 11.* Check that

$$u(x, y) = (\cos(y) - \sin(y))e^{-x}$$

is a harmonic function and find

$$\max_{(x,y) \in D} u(x, y) \quad \text{and} \quad \min_{(x,y) \in D} u(x, y)$$

and points, where they are achieved where

$$D = \{(x, y) : |y| \leq x\}.$$

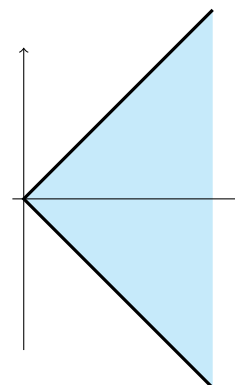

*Problem 12.* Check that

$$u(x, y) = \sin(y)e^{-x}$$

is a harmonic function and find

$$\max_{(x,y) \in D} u(x, y) \quad \text{and} \quad \min_{(x,y) \in D} u(x, y)$$

and points, where they are achieved where

$$D = \{(x, y) : |y| \leq \sqrt{3}x\}.$$

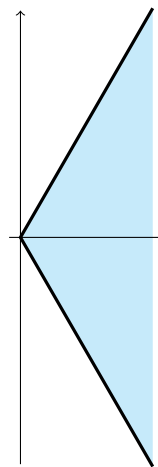

*Problem 13.* Check that

$$u(x, y) = -\sin(y)e^{-x}$$

is a harmonic function and find

$$\max_{(x,y) \in D} u(x, y) \quad \text{and} \quad \min_{(x,y) \in D} u(x, y)$$

and points, where they are achieved where

$$D = \{(x, y) : |y| \leq x/\sqrt{3}\}.$$

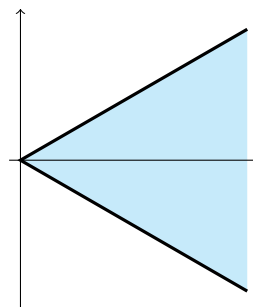

*Problem 14.* Check that

$$u(x, y) = xy$$

is a harmonic function and find

$$\max_{(x,y) \in D} u(x, y) \quad \text{and} \quad \min_{(x,y) \in D} u(x, y)$$

and points, where they are achieved where

$$D = \{(x, y) : (x - 1)^2 + y^2 \leq 1\}.$$

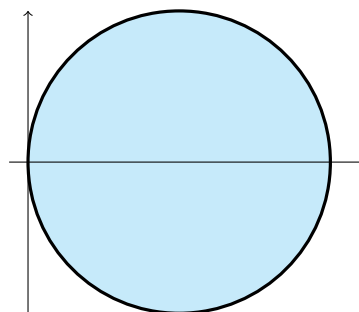



*Problem 15.* Check that

$$u(x, y) = x^2 - y^2$$

is a harmonic function and find

$$\max_{(x,y) \in D} u(x, y) \quad \text{and} \quad \min_{(x,y) \in D} u(x, y)$$

and points, where they are achieved where

$$D = \{(x, y) : (x - 1)^2 + y^2 \leq 1\}.$$

*Problem 16.* Check that

$$u(x, y) = xy$$

is a harmonic function and find

$$\max_{(x,y) \in D} u(x, y) \quad \text{and} \quad \min_{(x,y) \in D} u(x, y)$$

and points, where they are achieved where

$$D = \{(x, y) : (x - 2)^2 + y^2 \leq 1\}.$$

*Problem 17.* Check that

$$u(x, y) = x^2 - y^2$$

is a harmonic function and find

$$\max_{(x,y) \in D} u(x, y) \quad \text{and} \quad \min_{(x,y) \in D} u(x, y)$$

and points, where they are achieved where

$$D = \{(x, y) : (x - 2)^2 + y^2 \leq 1\}.$$

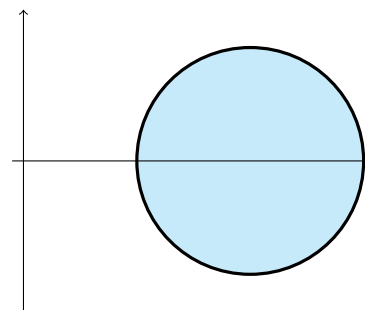

# Chapter 8

## Separation of variables

### 8.1 Separation of variables in spherical coordinates

#### 8.1.1 Harmonic polynomials

Consider Laplace equation in spherical coordinates defined by (6.3.7)–(6.3.8)

$$\Delta = \partial_\rho^2 + \frac{2}{\rho}\partial_\rho + \frac{1}{\rho^2}\Lambda \quad (8.1.1)$$

with

$$\Lambda := (\partial_\phi^2 + \cot(\phi)\partial_\phi) + \frac{1}{\sin^2(\phi)}\partial_\theta^2. \quad (8.1.2)$$

Let us plug  $u = P(\rho)Y(\phi, \theta)$  into  $\Delta u = 0$ :

$$P''(\rho)Y(\phi, \theta) + \frac{2}{\rho}P'(\rho)Y(\phi, \theta) + \frac{1}{\rho^2}P(\rho)\Lambda Y(\phi, \theta) = 0$$

which could be rewritten as

$$\frac{\rho^2 P''(\rho) + \rho P'(\rho)}{P(\rho)} + \frac{\Lambda Y(\phi, \theta)}{Y(\phi, \theta)} = 0$$

and since the first term depends only on  $\rho$  and the second only on  $\phi, \theta$  we conclude that both are constant:

$$\rho^2 P'' + 2\rho P' = \lambda P, \quad (8.1.3)$$

$$\Lambda Y(\phi, \theta) = -\lambda Y(\phi, \theta). \quad (8.1.4)$$

The first equation is of Euler type and it has solutions  $P := \rho^l$  iff  $\lambda = l(l+1)$ .

However if we are considering ball, solution *must* be infinitely smooth in its center due to Theorem 7.2.2 and this is possible iff  $l = 0, 1, 2, \dots$  and in this case  $u$  must be a polynomial of  $(x, y, z)$ .

**Definition 8.1.1.** Such polynomials are called *harmonic polynomials*.

**Theorem 8.1.1.** *Homogeneous harmonic polynomials of degree  $l$  form  $(2l+1)$ -dimensional space.*

*Sketch of the proof.* (a) Homogeneous polynomials of degree  $l$  form a space of dimension  $\binom{l+2}{2} = \frac{(l+2)(l+1)}{2}$ .

(b) For every homogeneous polynomial  $v$  of degree  $l-2$  there exists a homogeneous polynomial  $u$  of degree  $l$  such that  $v = \Delta u$ . One can prove it easily!

(c) Therefore the dimension of the space harmonic homogeneous polynomials of degree  $l$  equals  $\binom{l+2}{2} - \binom{l}{2} = 2l+1$ .  $\square$

| $l$ | Basis in the space of harmonic polynomials  |
|-----|---|
| 0   | 1   |
| 1   | $x, y, z$   |
| 2   | $xy, xz, yz, x^2 - y^2, x^2 - z^2$  |
| 3   | $x^3 - 3xz^2, y^3 - 3yz^2, xz^2 - xy^2, yz^2 - yx^2,$<br>$xyz, x^2z - y^2z, 2z^3 - 3x^2z - 3y^2z$ |

Table 8.1: Basis in the space of harmonic polynomials

Then

$$\Lambda Y(\phi, \theta) = -l(l+1)Y(\phi, \theta). \quad (8.1.5)$$

**Definition 8.1.2.** Solutions of  $\Lambda v = 0$  are called *spherical harmonics*.

To find spherical harmonics we apply method of separation of variables again:  $Y(\phi, \theta) = \Phi(\phi)\Theta(\theta)$ . Recalling

$$\Lambda := (\partial_\phi^2 + \cot(\phi)\partial_\phi) + \frac{1}{\sin^2(\phi)}\partial_\theta^2. \quad (8.1.2)$$

we see that

$$\underbrace{\frac{\sin^2(\phi)(\Phi'' + \cot(\phi)\Phi')}{\Phi}} + l(l+1)\sin^2(\phi) + \underbrace{\frac{\Theta''}{\Theta}} = 0. \quad (8.1.6)$$

Therefore again both terms in the left-hand expression must be constant:

$$\sin^2(\phi)(\Phi'' + \cot(\phi)\Phi') = -(l(l+1)\sin^2(\phi) - \mu)\Phi, \quad (8.1.7)$$

$$\Theta'' = -\mu\Theta. \quad (8.1.8)$$

The second equation  $\Theta'' = -\mu\Theta$  is easy, and keeping in mind  $2\pi$ -periodicity of  $\Theta$  we get  $\mu = m^2$  and  $\Theta = e^{-im\phi}$  with  $m = -l, 1-l, \dots, l-1, l$  (for  $|m| > l$  we would not get a polynomial).

Therefore (8.1.7) becomes

$$\sin^2(\phi)\Phi'' + \sin(\phi)\cos(\phi)\Phi' = -(l(l+1)\sin^2(\phi) - m^2)\Phi. \quad (8.1.9)$$

One can prove that  $\Phi$  is a function of  $\cos(\phi)$ :

**Theorem 8.1.2.**  $\Phi(\phi) = L(\cos(\phi))$  where  $L = P_l^m(z)$  is a polynomial for even  $m$  and  $L = P_l^m(z)$  is a polynomial multiplied by  $\sqrt{1-z^2} =: \sin(\phi)$  for odd  $m$ .

Such polynomials are called **Legendre polynomials** as  $m = 0$  and **Associated Legendre polynomials** as  $m \neq 0$ .

Legendre polynomials satisfy ODE

$$((1-z^2)P_l'(z))' + l(l+1)P_l = 0 \quad (8.1.10)$$

and are defined by

$$P_l(z) = \frac{1}{2^l l!} \left(\frac{d}{dz}\right)^l (z^2-1)^l. \quad (8.1.11)$$

Associated Legendre polynomials satisfy ODE

$$((1-z^2)P_l^{m'}(z))' + \left[l(l+1) - \frac{m^2}{1-z^2}\right]P_l^m = 0 \quad (8.1.12)$$

and are defined by

$$P_l^m(z) = (-1)^m (1-z^2)^{m/2} \left(\frac{d}{dz}\right)^m P_l(z). \quad (8.1.13)$$

Therefore we number **spherical harmonics** by  $l, m$ : we have  $Y_{lm}(\phi, \theta)$  with  $l = 0, 1, \dots$  and  $m = -l, -l+1, \dots, l-1, l$ .

*Remark 8.1.1.* (a) We are talking now about spherical harmonics with separated  $\phi, \theta$ ; linear combination of spherical harmonics with the same  $l$  but different  $m$  is again a spherical harmonic albeit without separated  $\phi, \theta$ .

(b) Such harmonics form a basis in the linear space of spherical harmonics with fixed  $l$ ;

(c) Choice of the polar axis  $z$  matters here: selecting other direction brings us a different basis.

### 8.1.2 Laplace equation outside the ball

Consider solutions of the Laplace equation for  $\rho > 0$  decaying as  $\rho \rightarrow \infty$ .

Since spherical harmonics are already defined we have  $\lambda = -l(l+1)$  and then  $P = \rho^k$  with  $k < 0$  satisfying  $k(k+1) = l(l+1)$  which implies that  $k = -1 - l$ .

In particular we get from Table 8.1

| $l$ | Basis in the space of homogeneous harmonic functions                      |
|-----|---|
| 0   | $1/\rho$  |
| 1   | $x/\rho^3, y/\rho^3, z/\rho^3$  |
| 2   | $xy/\rho^5, xz/\rho^5, yz/\rho^5, (x^2 - y^2)/\rho^5, (x^2 - z^2)/\rho^5$ |

Table 8.2: Basis in the space of homogeneous harmonic functions

with  $\rho = (x^2 + y^2 + z^2)^{1/2}$ .

### 8.1.3 Applications to the theory of hydrogen atom

Spherical harmonics play a crucial role in the problems with the spherical symmetry, in particular mathematical theory of Hydrogen-like atoms (with 1-electron):

$$-\frac{\hbar^2}{2\mu}\Delta\Psi - \frac{Ze^2}{\rho}\Psi = E\Psi. \quad (8.1.14)$$

Here  $\hbar$  is a Planck constant,  $-Ze$  is the charge of the nucleus,  $e$  is the charge of electron,  $\mu$  is its mass,  $E < 0$  is an energy level.

After separation of variables we get  $\Psi = P(\rho)Y_{lm}(\phi, \theta)$  with  $P$  satisfying

$$-P'' - \frac{2}{\rho}P' - \frac{\eta}{\rho}P + \frac{l(l+1)}{\rho^2}P = -\alpha^2P \quad (8.1.15)$$

with  $\eta = 2\mu Ze^2\hbar^{-2}$ ,  $\alpha = (-2E\mu)^{\frac{1}{2}}\hbar^{-1}$ .

Solutions are found in the form of  $e^{-\alpha\rho}\rho^lQ(\rho)$  where  $Q(\rho)$  is a polynomial satisfying

$$\rho Q'' + 2(l+1-\alpha\rho)Q' + (\eta - 2\alpha(l+1))Q = 0. \quad (8.1.16)$$

It is known that such solution (polynomial of degree exactly  $n-l-1$ ,  $n = l+1, l+2, \dots$ ) exists and is unique (up to a multiplication by a constant) iff

$$2\alpha(n-1) + 2\alpha - \eta = 0 \quad \text{i.e.} \quad \alpha = \frac{\eta}{2n}, \quad l \leq n-1.$$

Such polynomials are called **Laguerre polynomials**.

Therefore  $E_n = -\frac{\kappa}{n^2}$  (one can calculate  $\kappa$ ) and has multiplicity

$$\sum_{l=0}^{n-1} \sum_{m=-l}^l 1 = \sum_{l=0}^{n-1} (2l+1) = n^2.$$

*Remark 8.1.2.* We see that  $E_n$  are very degenerate. Different perturbations decrease or remove degenerations splitting these eigenvalues into clusters of less degenerate or non-degenerate eigenvalues.

### 8.1.4 Applications to wave equation in the ball

Consider now 3D-wave equation in the ball

$$u_{tt} - c^2\Delta u = 0 \quad \rho \leq a \quad (8.1.17)$$

with Dirichlet or Neumann boundary conditions. Separating  $t$  and the spatial variables  $u = T(t)v(x, y, z)$  we get *Helmholtz equation*

$$\Delta v = -\lambda v \quad \rho \leq a \quad (8.1.18)$$

with the same boundary condition and

$$T'' = -c^2\lambda T. \quad (8.1.19)$$

Separating  $\rho$  from spherical variables  $\phi, \theta$  we get

$$\underbrace{\frac{\rho^2 P'' + 2\rho P' + \lambda\rho^2 P}{P}} + \underbrace{\frac{\Lambda Y}{Y}} = 0$$

and therefore both selected expressions must be  $\mu$  and  $-\mu$  respectively.

So  $Y(\phi, \theta)$  is a spherical harmonic and  $\mu = l(l+1)$ .

Then

$$\rho^2 P'' + 2\rho P' + (\lambda\rho^2 - l(l+1))P = 0. \quad (8.1.20)$$

As  $\lambda = 1$  solutions are [spherical Bessel functions](#)  $j_l$  and  $y_l$  which are called *spherical Bessel functions of the 1st kind* and *of the 2nd kind*, respectively, and the former are regular at 0.

So  $P = j_l(\rho\sqrt{\lambda})$  and for  $u$  to satisfy Dirichlet or Neumann boundary conditions we need to impose the same conditions to  $P$  resulting in

$$j_l(a\sqrt{\lambda}) = 0, \quad (8.1.21)$$

$$j_l'(a\sqrt{\lambda}) = 0, \quad (8.1.22)$$

and then  $\lambda = z_{l,n}^2 a^{-2}$  and  $\lambda = w_{l,n}^2 a^{-2}$  respectively where  $z_{l,n}$  and  $w_{l,n}$  are  $n$ -th zero of  $j_l$  or  $j_l'$  respectively.

## 8.2 Separation of variables in polar and cylindrical coordinates

### 8.2.1 Helmholtz equation in the disk

Consider Helmholtz equation in the disc (recall that such equation is obtained from wave equation after separation of  $t$  from spatial variables):

$$v_{rr} + r^{-1}v_r - r^{-2}v_{\theta\theta} = -\lambda v \quad r \leq a. \quad (8.2.1)$$

Separating variables  $v = R(r)\Theta(\theta)$  we arrive to

$$\frac{r^2 R'' + rR' + \lambda r^2 R}{R} + \frac{\Theta''}{\Theta} = 0$$

and therefore

$$\Theta'' = -\mu\Theta, \quad (8.2.2)$$

$$r^2 R'' + rR' + (\lambda r^2 - \mu)R = 0 \quad (8.2.3)$$

and  $\mu = -l^2$ ,  $\Theta = e^{\pm il\theta}$  and

$$r^2 R'' + rR' + (\lambda r^2 - l^2)R = 0. \quad (8.2.4)$$

As  $\lambda = 1$  it is *Bessel equation* and solutions are [Bessel functions](#)  $J_l$  and  $Y_l$  which which are called *Bessel functions of the 1st kind* and *Bessel functions of the 2nd kind*, respectively, and the former are regular at 0. Therefore  $R = J_l(r\sqrt{\lambda})$  and plugging into Dirichlet or Neumann boundary conditions we get respectively

$$J_l(a\sqrt{\lambda}) = 0, \quad (8.2.5)$$

$$J'_l(a\sqrt{\lambda}) = 0, \quad (8.2.6)$$

and then  $\lambda = z_{l,n}^2 a^{-2}$  and  $\lambda = w_{l,n}^2 a^{-2}$  respectively where  $z_{l,n}$  and  $w_{l,n}$  are  $n$ -th zero of  $J_l$  or  $J'_l$  respectively.

*Remark 8.2.1.* Bessel functions are elementary functions only for half-integer  $l = \frac{1}{2}, \frac{3}{2}, \frac{5}{2}, \dots$  when they are related to spherical Bessel functions.

## 8.2.2 Helmholtz equation in the cylinder

Consider Laplace equation in the cylinder  $\{r \leq a, 0 \leq z \leq b\}$  with homogeneous Dirichlet (or Neumann, etc) boundary conditions:

$$u_{rr} + r^{-1}u_r + r^{-2}u_{\theta\theta} + u_{zz} = -\omega^2 u, \quad (8.2.7)$$

$$u|_{z=0} = u|_{z=b} = 0, \quad (8.2.8)$$

$$u|_{r=a} = 0. \quad (8.2.9)$$

Separating  $Z$  from  $r, \theta$   $u = Z(z)v(r, \theta)$  we get

$$\frac{\Lambda v}{v} + \frac{Z''}{Z} = -\omega^2 v$$

and then  $Z'' = -\beta Z$ , and  $\Lambda v := v_{rr} + r^{-1}v_r + r^{-2}v_{\theta\theta} = -\lambda v$  with  $\lambda = \omega^2 - \beta$  and from boundary conditions to  $Z$  we have  $\beta = \pi^2 m^2 b^{-2}$  and separating  $r, \theta$ :  $v = R(r)\Theta(\theta)$  we arrive again to

$$r^2 R'' + rR' + (\lambda r^2 - l^2)R = 0. \quad (8.2.4)$$

One can prove that there are no nontrivial solutions as  $\lambda \leq 0$  and therefore  $\lambda > 0$  and everything is basically reduced to the previous Subsection 8.2.1.

*Exercise 8.2.1.* Do it in detail.



### 8.2.3 Laplace equation in the cylinder

Consider Laplace equation in the cylinder  $\{r \leq a, 0 \leq z \leq b\}$  with homogeneous Dirichlet (or Neumann, etc) boundary conditions on the top and bottom leads and non-homogeneous condition on the lateral boundary:

$$u_{rr} + r^{-1}u_r + r^{-2}u_{\theta\theta} + u_{zz} = -\omega^2u, \quad (8.2.10)$$

$$u|_{z=0} = u|_{z=b} = 0, \quad (8.2.11)$$

$$u|_{r=a} = g(z, \theta). \quad (8.2.12)$$

Separating  $Z$  from  $r, \theta$  Separating  $Z$  from  $r, \theta$   $u = Z(z)v(r, \theta)$  we get

$$\frac{\Lambda v}{v} + \frac{Z''}{Z} = 0$$

and then  $Z'' = -\beta Z$ , and  $\Lambda v := v_{rr} + r^{-1}v_r + (-\beta + r^{-2}v_{\theta\theta}) = 0$  and from boundary conditions to  $Z$  we have  $\beta = \pi^2 m^2 b^{-2}$  and separating  $r, \theta$ :  $v = R(r)\Theta(\theta)$  we arrive like in the previous Subsection 8.2.2 to

$$r^2 R'' + rR' + (-\beta r^2 - l^2)R = 0. \quad (8.2.13)$$

However now  $\beta > 0$  and we do not need to satisfy homogeneous condition as  $r = a$  (on the contrary, we do not want it to have non-trivial solutions.

Then we use [modified Bessel functions](#)  $I_l$  and  $K_l$  and  $R = CI_l(r\sqrt{\beta})$ .

## Separation of variable in elliptic and parabolic coordinates

Recall that elliptic and parabolic coordinates, and also elliptic cylindrical and parabolic cylindrical coordinates are described in Subsection 6.3.4.

### 8.A.1 Laplace equation in the ellipse

Consider Laplace equation in the elliptic coordinates  $(\mu, \nu)$ :

$$\Delta u = \frac{1}{c^2(\sinh^2(\mu) + \sin^2(\nu))}(\partial_\mu^2 + \partial_\nu^2)u = 0 \quad (8.A.1)$$

which is obviously equivalent to

$$(\partial_\mu^2 + \partial_\nu^2)u = 0; \quad (8.A.2)$$

separating variables  $u = M(\mu)N(\nu)$  we arrive to  $M'' = \alpha M$ ,  $N'' = -\alpha N$  with periodic boundary conditions for  $N$ ; so  $N = \cos(n\nu), \sin(n\nu)$ ,  $\alpha = n^2$  and  $N = A \cosh(n\mu) + B \sinh(n\mu)$ . So

$$u_n = A \cosh(n\mu) \cos(n\nu) + B \cosh(n\mu) \sin(n\nu) + C \sinh(n\mu) \cos(n\nu) + D \sinh(n\mu) \sin(n\nu) \quad (8.A.3)$$

as  $n = 1, 2, \dots$  and similarly

$$u_0 = A + Bu. \quad (8.A.4)$$

### 8.A.2 Laplace equation in the parabolic annulus

Consider Laplace equation in the parabolic coordinates  $(\sigma, \tau)$ :

$$\Delta u = \frac{1}{\sigma^2 + \tau^2} (\partial_\sigma^2 + \partial_\tau^2) u = 0. \quad (8.A.5)$$

Then again formulae (8.A.3) and (8.A.4) work but with  $(\mu, \nu)$  replaced by  $(\sigma, \tau)$ .

### 8.A.3 Helmholtz equation in the ellipse

Consider Helmholtz equation in the elliptic coordinates  $(\mu, \nu)$ :

$$\Delta u = \frac{1}{c^2(\sinh^2(\mu) + \sin^2(\nu))} (\partial_\mu^2 + \partial_\nu^2) u = -k^2 u \quad (8.A.6)$$

which can be rewritten as

$$\left( \partial_\mu^2 + k^2 c^2 \sinh^2(\mu) + \partial_\nu^2 + \sin^2(\nu) \right) u = 0 \quad (8.A.7)$$

and separating variables we get

$$M'' + k^2 c^2 (\sinh^2(\mu) + \lambda) M = 0, \quad (8.A.8)$$

$$N'' + k^2 c^2 (\sin^2(\nu) - \lambda) N = 0. \quad (8.A.9)$$

### 8.A.4 Helmholtz equation in the parabolic annulus

Consider Helmholtz equation in the parabolic coordinates  $(\sigma, \tau)$ :

$$\Delta u = \frac{1}{\sigma^2 + \tau^2}(\partial_\sigma^2 + \partial_\tau^2)u = -k^2 u \quad (8.A.10)$$

which can be rewritten as

$$\left(\partial_\sigma^2 + k^2\sigma^2 + \partial_\tau^2 + k^2\tau^2\right)u = 0 \quad (8.A.11)$$

and separating variables we get

$$S'' + k^2(\sigma^2 + \lambda)S = 0, \quad (8.A.12)$$

$$N'' + k^2(\tau^2 - \lambda)T = 0. \quad (8.A.13)$$

### 8.A.5 Other coordinates

*Exercise 8.A.1.* Consider Laplace and Helmholtz equations in elliptic cylindrical and parabolic cylindrical coordinates.

## Problems to Chapter 8

*Problem 1.* (a) Write Laplace equation in spherical coordinates.

(b) Look for a solution in the form  $u = P(\rho)\Phi(\phi)\Theta(\theta)$ .

(c) Write equations and their solutions for  $P$  and  $\Theta$ .

(d) Write equation (with parameters  $l$  and  $m$ ) for  $\Phi$ ; what values can take  $(l, m)$ ?

*Problem 2.* For equation to  $\Phi$  find solutions in the form  $L(\cos(\phi), \sin(\phi))$  where  $L$  is a polynomial of degree  $l$  with respect to  $\cos(\phi), \sin(\phi)$  in the following cases:

(a)  $l = 0$  and all possible values  $m$ ;

(b)  $l = 1$  and all possible values  $m$ ;

(c)  $l = 2$  and all possible values  $m$ ;

(d)  $l = 3$  and  $m = 0$ .

*Problem 3.* (i) Solve

$$\begin{aligned} \Delta u &= 0 & x^2 + y^2 + z^2 &< 1, \\ u &= g(x, y, z) & x^2 + y^2 + z^2 &= 1 \end{aligned}$$

with  $g(x, y, z)$  defined below.

*Hint.* If  $g$  is a polynomial of degree  $m$  look for

$$u = g - P(x, y, z)(x^2 + y^2 + z^2 - R^2)$$

with  $P$  a polynomial of degree  $(m - 2)$ . Here  $R$  is the radius of the ball. If  $g$  has some rotational symmetry, so  $P$  has.

(ii) Represent  $u$  as a sum of homogeneous harmonic polynomials.

(iii) Plug  $x = \rho \sin(\phi) \cos(\theta)$ ,  $y = \rho \sin(\phi) \sin(\theta)$ ,  $z = \rho \cos(\phi)$ .

- |                                     |                                     |
|-------------------------------------|-------------------------------------|
| (a) $g = x^2 + y^2 - z^2$ ;         | (i) $g(x, y, z) = (x^2 + y^2)^2$ ;  |
| (b) $g = z(x^2 + y^2)$ ;            | (j) $g(x, y, z) = x^3yz$ ;          |
| (c) $g = xyz$ .                     | (k) $g(x, y, z) = (x^2 + y^2)^2$ ;  |
| (d) $g = x^4 + y^4 + z^4$ ;         | (l) $g(x, y, z) = (x^2 - y^2)^2$ ;  |
| (e) $g(x, y, z) = x^4$ ;            | (m) $g(x, y, z) = x^5$ ;            |
| (f) $g(x, y, z) = x^4 3y$ ;         | (n) $g(x, y, z) = x^3(y^2 + z^2)$ ; |
| (g) $g(x, y, z) = x^2yz$ ;          | (o) $g(x, y, z) = x(y^2 + z^2)^2$ . |
| (h) $g(x, y, z) = x^2(y^2 + z^2)$ ; |                                     |

*Problem 4.* In the following problems use spherical coordinates, observe that solution must be spherically symmetric:  $u = u(r, t)$  (explain why). Represent solution as a corresponding Fourier series with respect to  $r$ . Also, use equality

$$ru_{rr} + 2u_r = (ru)_{rr}.$$

$$(a) \begin{cases} u_{tt} - \Delta u = 0, \\ u|_{r=1} = 0, \\ u|_{t=0} = 0, \\ u_t|_{t=0} = \sin(\pi r) \end{cases}$$

$$(b) \begin{cases} u_{tt} - \Delta u = 0, \\ u|_{r=1} = 0, \\ u|_{t=0} = 1 - r, \\ u_t|_{t=0} = 0. \end{cases}$$

$$(c) \begin{cases} u_t - \Delta u = 0, \\ u|_{r=1} = 0, \\ u|_{t=0} = \cos(\pi r). \end{cases}$$

$$(d) \begin{cases} u_t - \Delta u = 0, \\ u|_{r=1} = 0, \\ u|_{t=0} = 1 - r. \end{cases}$$

$$(e) \begin{cases} u_{tt} - \Delta u = 0, \\ (u_r + u)|_{r=1} = 0, \\ u|_{t=0} = 0, \\ u_t|_{t=0} = \cos(\pi r). \end{cases}$$

$$(f) \begin{cases} u_{tt} - \Delta u = 0, \\ (u_r + u)|_{r=1} = 0, \\ u|_{t=0} = 2 - r, \\ u_t|_{t=0} = 0. \end{cases}$$

$$(g) \begin{cases} u_t - \Delta u = 0, \\ (u_r + u)|_{r=1} = 0, \\ u|_{t=0} = \sin\left(\frac{\pi r}{2}\right). \end{cases}$$

$$(h) \begin{cases} u_t - \Delta u = 0, \\ (u_r + u)|_{r=1} = 0, \\ u|_{t=0} = r, \end{cases}$$

$$(i) \begin{cases} u_{tt} - \Delta u = 0, \\ u|_{r=\frac{1}{2}} = 0, \\ u|_{t=0} = \cos(\pi r), \\ u_t|_{t=0} = 0 \end{cases}$$

$$(j) \begin{cases} u_{tt} - \Delta u = 0, \\ u|_{r=2} = 0, \\ u|_{t=0} = \sin(\pi r), \\ u_t|_{t=0} = 0. \end{cases}$$

$$(k) \begin{cases} u_t - \Delta u = 0, \\ (u_r + 2u)|_{r=2} = 0, \\ u|_{t=0} = \sin(\pi r). \end{cases}$$

$$(l) \begin{cases} u_t - \Delta u = 0, \\ (2u_r + u)|_{r=1} = 0, \\ u|_{t=0} = \sin(\pi r). \end{cases}$$

# Chapter 9

## Wave equation

### 9.1 Wave equation in dimensions 3 and 2

#### 9.1.1 3D-Wave equation: special case

Consider Cauchy problem for 3-dimensional wave equation

$$u_{tt} - c^2 \Delta u = f, \quad (9.1.1)$$

$$u|_{t=0} = g, \quad (9.1.2)$$

$$u_t|_{t=0} = h. \quad (9.1.3)$$

Assume first that  $f = g = 0$ . We claim that in this case as  $t > 0$

$$u(\mathbf{x}, t) = \frac{1}{4\pi c^2 t} \iint_{S(\mathbf{x}, ct)} h(\mathbf{y}) d\sigma \quad (9.1.4)$$

where we integrate along sphere  $S(\mathbf{x}, ct)$  with a center at  $\mathbf{x}$  and radius  $ct$ ;  $d\sigma$  is an area element.

Let us prove (9.1.4) first as  $h(\mathbf{x}) = e^{i\mathbf{x}\cdot\boldsymbol{\xi}}$  with  $\boldsymbol{\xi} \in \mathbb{R}^3 \setminus 0$ ; we use the standard notation  $\mathbf{x} \cdot \boldsymbol{\xi} = x_1\xi_1 + x_2\xi_2 + x_3\xi_3$ . In this case

$$u(\mathbf{x}, t) = e^{i\mathbf{x}\cdot\boldsymbol{\xi}} c^{-1} |\boldsymbol{\xi}|^{-1} \sin(ct|\boldsymbol{\xi}|) \quad (9.1.5)$$

is obviously a solution to Cauchy problem (9.1.1)–(9.1.3).

On the other hand, the right-hand expression of (9.1.4) becomes

$$\frac{1}{4\pi c^2 t} \iint_{S(\mathbf{x}, ct)} e^{i\mathbf{y}\cdot\boldsymbol{\xi}} d\sigma = \frac{1}{4\pi c^2 t} e^{i\mathbf{x}\cdot\boldsymbol{\xi}} \iint_{S(0, ct)} e^{i\mathbf{z}\cdot\boldsymbol{\xi}} d\sigma$$

where we changed variable  $\mathbf{y} = \mathbf{x} + \mathbf{z}$  with  $\mathbf{z}$  running  $S(0, ct)$  (sphere with a center at 0) and we need to calculate integral in the right-hand expression.

Let us select coordinate system in which  $\boldsymbol{\xi} = (0, 0, \omega)$  with  $\omega = |\boldsymbol{\xi}|$  and introduce corresponding spherical coordinates  $(\rho, \phi, \theta)$ ; then on  $S(0, ct)$   $\rho = ct$ ,  $\mathbf{z} \cdot \boldsymbol{\xi} = z_3\omega = ct\omega \cos(\phi)$  and  $d\sigma = c^2t^2 \sin(\phi)d\phi d\theta$ ; so integral becomes

$$\begin{aligned} c^2t^2 \int_0^\pi e^{ict\omega \cos(\phi)} \sin(\phi) d\phi \int_0^{2\pi} d\theta = \\ - 2\pi c^2t^2 \int_0^\pi e^{ict\omega \cos(\phi)} d\cos(\phi) = 2\pi c^2t^2 \frac{1}{ict\omega} \left( e^{ict\omega} - e^{-ict\omega} \right) = \\ 4\pi ct\omega^{-1} \sin(ct\omega). \end{aligned}$$

Multiplying by  $e^{i\mathbf{x} \cdot \boldsymbol{\xi}}$  and dividing by  $4\pi c^2t$  we get  $e^{i\mathbf{x} \cdot \boldsymbol{\xi}} c^{-1} |\boldsymbol{\xi}|^{-1} \sin(ct|\boldsymbol{\xi}|)$  which is the right-hand expression of (9.1.5).

So, for  $h(\mathbf{x}) = e^{i\mathbf{x} \cdot \boldsymbol{\xi}}$  (9.1.4) has been proven. However the general function  $h(\mathbf{x})$  could be decomposed into such special functions using *multidimensional Fourier transform* and *multidimensional Fourier integral* which is nothing but repeated 1-dimensional Fourier transform and Fourier integral:

$$h(\mathbf{x}) = \iiint \hat{h}(\boldsymbol{\xi}) e^{i\mathbf{x} \cdot \boldsymbol{\xi}} d\boldsymbol{\xi}, \quad (9.1.6)$$

$$\hat{h}(\boldsymbol{\xi}) = (2\pi)^{-n} \iiint h(\mathbf{x}) e^{-i\mathbf{x} \cdot \boldsymbol{\xi}} d\mathbf{x} \quad (9.1.7)$$

and therefore (9.1.4) extends to general functions as well.

*Remark 9.1.1.* We should deal with the fact that only decaying functions could be decomposed into Fourier integral, but this is easy due to the fact that integral in (9.1.4) is taken over bounded domain.

### 9.1.2 3D-Wave equation: general case

To cover  $t < 0$  we replace (9.1.4) by

$$u(\mathbf{x}, t) = \frac{1}{4\pi c^2t} \iint_{S(\mathbf{x}, c|t|)} h(\mathbf{y}) d\sigma \quad (9.1.8)$$

which is obvious as  $u$  must be odd with respect to  $t$  (explain why).

Consider now  $g \neq 0$ . Let  $v(\mathbf{x}, t)$  be given by (9.1.8) with  $h$  replaced by  $g$ ; then

$$\begin{aligned}v_{tt} - c^2 \Delta v &= 0, \\v|_{t=0} &= 0, \\v_t|_{t=0} &= g.\end{aligned}$$

Then  $\Delta v|_{t=0} = 0$  and therefore  $v_{tt}|_{t=0} = 0$  and therefore differentiating equation with respect to  $t$  we conclude that  $u := v_t$  solves

$$\begin{aligned}u_{tt} - c^2 \Delta u &= 0, \\u|_{t=0} &= g, \\u_t|_{t=0} &= 0.\end{aligned}$$

Now

$$u(\mathbf{x}, t) = \frac{\partial}{\partial t} \left( \frac{1}{4\pi c^2 t} \iint_{S(\mathbf{x}, c|t)} g(\mathbf{y}) d\sigma \right). \quad (9.1.9)$$

Therefore solving separately (9.1.1)–(9.1.3) for  $f = g = 0$  (given by (9.1.8)) and for  $f = h = 0$  (given by (9.1.9)) and adding solutions due to linearity we arrive to

$$u(\mathbf{x}, t) = \frac{\partial}{\partial t} \left( \frac{1}{4\pi c^2 t} \iint_{S(\mathbf{x}, c|t)} g(\mathbf{y}) d\sigma \right) + \frac{1}{4\pi c^2 t} \iint_{S(\mathbf{x}, c|t)} h(\mathbf{y}) d\sigma \quad (9.1.10)$$

covering case  $f = 0$ .

To cover case of arbitrary  $f$  but  $g = h = 0$  we apply Duhamel integral formula (see Subsection 2.5.2). Namely, consider problem

$$\begin{aligned}U_{tt} - c^2 \Delta U &= 0, \\U|_{t=\tau} &= 0, \\U_t|_{t=\tau} &= f(\mathbf{x}, \tau).\end{aligned}$$

Its solution is given by

$$U(\mathbf{x}, t, \tau) = \frac{1}{4\pi c^2 (t - \tau)} \iint_{S(\mathbf{x}, c|t-\tau)} f(\mathbf{y}, \tau) d\sigma$$



and therefore

$$u(\mathbf{x}, t) = \int_0^t \frac{1}{4\pi c^2(t-\tau)} \iint_{S(\mathbf{x}, c|t-\tau|)} f(\mathbf{y}, \tau) d\sigma d\tau. \quad (9.1.11)$$

Assembling (9.1.10) and (9.1.11) together we arrive to *Kirchhoff formula*

$$u(\mathbf{x}, t) = \frac{\partial}{\partial t} \left( \frac{1}{4\pi c^2 t} \iint_{S(\mathbf{x}, c|t|)} g(\mathbf{y}) d\sigma \right) + \frac{1}{4\pi c^2 t} \iint_{S(\mathbf{x}, c|t|)} h(\mathbf{y}) d\sigma + \int_0^t \frac{1}{4\pi c^2(t-\tau)} \iint_{S(\mathbf{x}, c|t-\tau|)} f(\mathbf{y}, \tau) d\sigma d\tau. \quad (9.1.12)$$

providing solution to (9.1.1)–(9.1.3).

*Remark 9.1.2.* As  $t > 0$  one can rewrite the last term in (9.1.12) as

$$\iiint_{B(\mathbf{x}, ct)} \frac{1}{4\pi c^2 |\mathbf{x} - \mathbf{y}|} f(\mathbf{y}, t - c^{-1}|\mathbf{x} - \mathbf{y}|) d\mathbf{y} \quad (9.1.13)$$

where we integrate over ball  $B(\mathbf{x}, ct)$  of radius  $ct$  with the center at  $\mathbf{x}$ . It is called *time-delayed potential*.

### 9.1.3 Spherical means

**Definition 9.1.1.**

$$M_r(h, \mathbf{x}) = \frac{1}{4\pi r^2} \iint_{S(\mathbf{x}, r)} h(\mathbf{y}) d\sigma = \frac{1}{4\pi} \iint_{S(0,1)} h(\mathbf{x} + \omega r) d\omega, \quad (9.1.14)$$

where  $d\sigma$  and  $d\omega$  are area elements respectively on  $S(\mathbf{x}, r)$  and  $S(0, 1)$ , is a *spherical mean* of  $h$ . Recall that  $4\pi r^2$  is an area of  $S(\mathbf{x}, r)$ .

Therefore

$$u(\mathbf{x}, t) = \frac{1}{4\pi c^2 t} \iint_{S(\mathbf{x}, c|t|)} h(\mathbf{y}) d\sigma \quad (9.1.8)$$

is exactly  $u(\mathbf{x}, t) = tM_{c|t|}(h, \mathbf{x})$  and all other formulae (9.1.9)–(9.1.13) could be modified similarly.

*Remark 9.1.3.* (a) Another proof of Kirchhoff formula is based on spherical means.

(A) First, one can prove that if  $u(\mathbf{x}, t)$  satisfies wave equation  $u_{tt} - c^2 \Delta u = 0$ , then  $v(x; r, t) = rM_r(u, \mathbf{x})$  satisfies 1D-wave equation  $v_{tt} - c^2 v_{rr} = 0$ . Here  $\mathbf{x}$  is considered as a parameter.

(B) Then  $v$  can be written through D'Alembert formula. Plugging it into  $\partial_r v|_{r=0} = u(\mathbf{x}; t)$ , we arrive to

$$u(\mathbf{x}, t) = \frac{1}{4\pi c^2 t} \iint_{S(\mathbf{x}, ct)} h(\mathbf{y}) d\sigma \quad (9.1.4)$$

if  $u|_{t=0} = 0$ ,  $u_t|_{t=0} = h(\mathbf{x})$ .

(b) Yet another proof could be done, using [Radon transform](#), in particular, it's intertwining property.

### 9.1.4 2D-Wave equation: method of descent

Consider now the same problem (9.1.1)–(9.1.3) but in dimension 2. To apply (9.1.12) we introduce a third spatial variable  $x_3$  and take  $f, g, h$  not depending on it; then  $u$  also does not depend on  $x_3$  and solves original 2D-problem.

So, the right-hand expression in (9.1.8) becomes for  $\pm t > 0$

$$\frac{1}{4\pi c^2 t} \iint_{S(\mathbf{x}, c|t|)} h(\mathbf{y}) d\sigma = \pm \frac{1}{2\pi c} \iint_{D(\mathbf{x}, c|t|)} \frac{h(\mathbf{y})}{\sqrt{c^2 t^2 - |\mathbf{x} - \mathbf{y}|^2}} dy \quad (9.1.15)$$

where  $\mathbf{y} = (y_1, y_2)$  and we took into account that  $S(\mathbf{x}, ct)$  covers disk  $D(\mathbf{y}, c|t|)$  twice (so factor 2 appears) and

$$d\sigma = \pm \frac{ct}{\sqrt{c^2 t^2 - |\mathbf{x} - \mathbf{y}|^2}} dy, \quad dy = dy_1 dy_2.$$

Thus 3D-formula

$$u(\mathbf{x}, t) = \frac{\partial}{\partial t} \left( \frac{1}{4\pi c^2 t} \iint_{S(\mathbf{x}, c|t|)} g(\mathbf{y}) d\sigma \right) + \frac{1}{4\pi c^2 t} \iint_{S(\mathbf{x}, c|t|)} h(\mathbf{y}) d\sigma + \int_0^t \frac{1}{4\pi c^2 (t - \tau)} \iint_{S(\mathbf{x}, c|t-\tau|)} f(\mathbf{y}, \tau) d\sigma d\tau. \quad (9.1.12)$$

implies that for  $\pm t > 0$  the following 2D-formula holds:

$$\begin{aligned} u(\mathbf{x}, t) = & \pm \frac{\partial}{\partial t} \left( \frac{1}{2\pi c} \iint_{D(\mathbf{x}, c|t|)} \frac{g(\mathbf{y})}{\sqrt{c^2 t^2 - |\mathbf{x} - \mathbf{y}|^2}} dy \right) \\ & \pm \frac{1}{2\pi c} \iint_{D(\mathbf{x}, c|t|)} \frac{h(\mathbf{y})}{\sqrt{c^2 t^2 - |\mathbf{x} - \mathbf{y}|^2}} dy \\ & \pm \int_0^t \frac{1}{2\pi c} \iint_{D(\mathbf{x}, c|t-\tau|)} \frac{f(\mathbf{x}, \tau)}{\sqrt{c^2(t-\tau)^2 - |\mathbf{x} - \mathbf{y}|^2}} dy d\tau. \end{aligned} \quad (9.1.16)$$

### 9.1.5 Limiting amplitude principle

Let  $n = 3$ . Consider solution to inhomogeneous wave equation with a special right-hand expression

$$\Delta u - c^{-2} u_{tt} = f(\mathbf{x}) e^{i\omega t} \quad (9.1.17)$$

where  $\omega \neq 0$  and  $f(\mathbf{x})$  does not depend on  $t$  and fast decays as  $|\mathbf{x}| \rightarrow \infty$ . Assume that  $g(\mathbf{x}) = u(\mathbf{x}, 0)$  and  $h(\mathbf{x}) = u_t(\mathbf{x}, 0)$  also fast decay as  $|\mathbf{x}| \rightarrow \infty$ . Plugging all these functions into Kirchhoff formula

$$\begin{aligned} u(\mathbf{x}, t) = & \frac{\partial}{\partial t} \left( \frac{1}{4\pi c^2 t} \iint_{S(\mathbf{x}, c|t|)} g(\mathbf{y}) d\sigma \right) + \frac{1}{4\pi c^2 t} \iint_{S(\mathbf{x}, c|t|)} h(\mathbf{y}) d\sigma + \\ & \int_0^t \frac{1}{4\pi c^2(t-\tau)} \iint_{S(\mathbf{x}, c|t-\tau|)} f(\mathbf{y}, \tau) d\sigma d\tau \end{aligned} \quad (12)$$

and considering  $|t| \gg 1$  and fixed  $\mathbf{x}$  we see that the first two terms tend to 0 for fixed  $x$  and  $\pm t \rightarrow \infty$  while the last term becomes

$$\begin{aligned} & \int_0^t \frac{1}{4\pi c^2(t-\tau)} \iint_{S(\mathbf{x}, c|t-\tau|)} f(\mathbf{y}) e^{i\omega\tau} d\sigma d\tau \\ & = -\frac{1}{4\pi} \iiint_{B(\mathbf{x}, c|t|)} |\mathbf{x} - \mathbf{y}|^{-1} e^{\mp i\omega c^{-1}|\mathbf{x}-\mathbf{y}|} dy \end{aligned}$$

and therefore

$$|u(\mathbf{x}, t) - v_\omega^\pm(\mathbf{x}) e^{i\omega t}| \rightarrow 0 \quad \text{as } t \rightarrow \pm\infty \quad (9.1.18)$$

with

$$v_{\omega}^{\pm}(\mathbf{x}) = -\frac{1}{4\pi} \iiint |\mathbf{x} - \mathbf{y}|^{-1} e^{\mp i\omega c^{-1}|\mathbf{x}-\mathbf{y}|} dy. \quad (9.1.19)$$

One can check easily that  $v = v_{\omega}^{\pm}$  satisfies *1D-Helmholtz equation*

$$\left(\Delta + \frac{\omega^2}{c^2}\right)v = f(\mathbf{x}) \quad (9.1.20)$$

with *Sommerfeld radiating conditions*

$$v = o(1) \quad \text{as } r \rightarrow \infty, \quad (9.1.21)$$

$$(\partial_r \mp ic^{-1}\omega)v = o(r^{-1}) \quad \text{as } r \rightarrow \infty \quad (9.1.22)$$

where  $r := |\mathbf{x}|$  and  $\partial_r := |\mathbf{x}|^{-1}\mathbf{x} \cdot \nabla$ .

This is called *Limiting amplitude principle*.

*Remark 9.1.4.* (a) Formula (9.1.19) gives us Green's function for problem (9.1.20)-(9.1.22)

$$G_{\omega}^{\pm}(\mathbf{x}, \mathbf{y}) = -\frac{1}{4\pi} |\mathbf{x} - \mathbf{y}|^{-1} e^{\mp i\omega c^{-1}|\mathbf{x}-\mathbf{y}|} \quad (9.1.23)$$

which coincides as  $\omega = 0$  with a Green's function for Laplace equation  $G(\mathbf{x}, \mathbf{y}) = -\frac{1}{4\pi} |\mathbf{x} - \mathbf{y}|^{-1}$ .

(b) However now we have two Green's functions as (9.1.23) distinguishes and between them and  $u(\mathbf{x}, t)$  has different amplitudes  $v_{\omega}^{\pm}(\mathbf{x})$  as  $t \rightarrow \pm\infty$ .

(c) For fast-decaying  $f(\mathbf{x})$  one can replace in (9.1.21) and (9.1.22)  $o(1)$  and  $o(r^{-1})$  by  $O(r^{-1})$  and  $O(r^{-2})$  respectively.

### 9.1.6 Spherical waves

Let  $n = 3$ . Consider *spherically symmetric solution*  $u(\mathbf{x}, t) = u(r, t)$  of the wave equation. Since for spherically symmetric  $u$   $\Delta u = u_{rr} + \frac{2}{r}u_r$  we can rewrite it as

$$u_{tt} - c^2\left(u_{rr} + \frac{2}{r}u_r\right) = 0$$

or, equivalently

$$(ru)_{tt} - c^2(ru)_{rr} = 0. \quad (9.1.24)$$

Therefore  $ru(r, t) = \phi(r - ct) + \psi(r + ct)$  and since  $(ru)|_{r=0} = 0$  we conclude that  $\psi(ct) = -\phi(-ct)$  and therefore

$$u = \frac{1}{r}(\phi(r - ct) - \phi(-r - ct)). \quad (9.1.25)$$

This is *spherical wave*. Similar non-trivial solutions

$$u = r^\alpha(\phi(r - ct) - \phi(-r - ct))$$

do not exist for  $n = 2$ .

### 9.1.7 Remarks

*Remark 9.1.5.* (a) Formula (9.1.12) could be generalized to the case of odd  $n \geq 3$ :

$$\begin{aligned} u(\mathbf{x}, t) = & c^{1-n} \kappa_n \frac{\partial}{\partial t} \left( \frac{1}{t} \frac{\partial}{\partial t} \right)^{\frac{n-3}{2}} \left( t^{-1} \iint_{S(\mathbf{x}, c|t)} g(\mathbf{y}) d\sigma \right) \\ & + c^{1-n} \kappa_n \left( \frac{1}{t} \frac{\partial}{\partial t} \right)^{\frac{n-3}{2}} \left( t^{-1} \iint_{S(\mathbf{x}, c|t)} h(\mathbf{y}) d\sigma \right) \end{aligned} \quad (9.1.26)$$

provided  $f = 0$  (which could be generalized to  $f \neq 0$  using Duhamel principle).

Here  $\kappa_n$  is a numerical coefficient which could be easily calculated from  $g \equiv 1$ ,  $h \equiv 0$ ,  $f \equiv 0 \implies u \equiv 1$ .

(b) Formula (9.1.16) could be generalized to the case of even  $n \geq 2$ , again obtained by the method of descent

$$\begin{aligned} u(\mathbf{x}, t) = & c^{1-n} \kappa_n \frac{\partial}{\partial t} \left( \frac{1}{t} \frac{\partial}{\partial t} \right)^{\frac{n-2}{2}} \left( \iiint_{B(\mathbf{x}, c|t)} \frac{g(\mathbf{y})}{(c^2 t^2 - |\mathbf{x} - \mathbf{y}|^2)^{\frac{1}{2}}} dy \right) \\ & + c^{1-n} \kappa_n \left( \frac{1}{t} \frac{\partial}{\partial t} \right)^{\frac{n-2}{2}} \left( \iiint_{B(\mathbf{x}, c|t)} \frac{h(\mathbf{y})}{(c^2 t^2 - |\mathbf{x} - \mathbf{y}|^2)^{\frac{1}{2}}} dy \right) \end{aligned} \quad (9.1.27)$$

provided  $f = 0$  (which could be generalized to  $f \neq 0$  using Duhamel principle).

(c) These formulae imply that  $u(\mathbf{x}, t)$  does not depend on  $g(\mathbf{y}), h(\mathbf{y})$  with  $|\mathbf{x} - \mathbf{y}| > ct$  and on  $f(\mathbf{y}, \tau)$  with  $|\mathbf{x} - \mathbf{y}| > c|t - \tau|$ . This could be interpreted as “nothing propagates with a speed exceeding  $c$ ”.

(d) We will prove it again by completely different method in the next Section 9.2.

(e) Further, for odd  $n \geq 3$  solution  $u(\mathbf{x}, t)$  does not depend on  $g(\mathbf{y}), h(\mathbf{y})$  with  $|\mathbf{x} - \mathbf{y}| < ct$  and on  $f(\mathbf{y}, \tau)$  with  $|\mathbf{x} - \mathbf{y}| < c|t - \tau|$ . This could be interpreted as “no leftovers after front passed with a speed  $c$ ”.

In mathematical literature this is called *Huygens principle* (there is another Huygens principle a.k.a. [Huygens-Fresnel principle](#)). This property is a rare commodity: adding lower-order terms to the equation breaks it.

## 9.2 Wave equation: energy method

### 9.2.1 Energy method: local form

Consider wave equation

$$u_{tt} - c^2 \Delta u = 0. \quad (9.2.1)$$

Multiplying by  $u_t$  we arrive to

$$\begin{aligned} 0 = u_t u_{tt} - c^2 u_t \Delta u &= \frac{1}{2} \partial_t (u_t^2) - c^2 \nabla \cdot (u_t \nabla u) + c^2 \nabla u_t \cdot \nabla u = \\ & \frac{1}{2} \partial_t (u_t^2 + c^2 |\nabla u|^2) - c^2 \nabla \cdot (u_t \nabla u) \end{aligned}$$

that is

$$\frac{1}{2} \partial_t (u_t^2 + c^2 |\nabla u|^2) - c^2 \nabla \cdot (u_t \nabla u) = 0. \quad (9.2.2)$$

This is an *energy conservation law in the local form*. If we integrate over domain  $\Omega \subset \mathbb{R}_t \times \mathbb{R}_x^n$  we arrive to

$$\iint_{\Sigma} \left( (u_t^2 + |\nabla u|^2) \nu_t - 2c^2 u_t \nabla u \cdot \boldsymbol{\nu}_x \right) d\sigma = 0 \quad (9.2.3)$$

where  $\Sigma$  is a boundary of  $\Omega$ ,  $\boldsymbol{\nu}$  is an external normal and  $d\sigma$  is an element of “area”;  $\nu_t$  and  $\boldsymbol{\nu}_x$  are its  $t$  and  $x$  components.

## 9.2.2 Classification of hypersurfaces

Consider a quadratic form

$$Q(U_0, \mathbf{U}) = U_0^2 + |\mathbf{U}|^2 - 2U_0c\nu_t^{-1}\boldsymbol{\nu}_x \cdot \mathbf{U}. \quad (9.2.4)$$

**Proposition 9.2.1.** (i) If  $c|\boldsymbol{\nu}_x| < |\nu_t|$  then  $Q$  is positive definite (i.e.  $Q(U_0, \mathbf{U}) \geq 0$  and  $Q(U_0, \mathbf{U}) = 0$  iff  $U_0 = \mathbf{U} = 0$ );

(ii) If  $c|\boldsymbol{\nu}_x| = |\nu_t|$  then  $Q$  is non-negative definite (i.e.  $Q(U_0, \mathbf{U}) \geq 0$ );

(iii) If  $c|\boldsymbol{\nu}_x| > |\nu_t|$  then  $Q$  is not non-negative definite.

*Proof.* Proof is obvious. □

**Definition 9.2.1.** (a) If  $c|\boldsymbol{\nu}_x| < |\nu_t|$  then  $\Sigma$  is a *space-like surface* (in the given point).

(b) If  $c|\boldsymbol{\nu}_x| = |\nu_t|$  then  $\Sigma$  is a *characteristic* (in the given point).

(c) If  $c|\boldsymbol{\nu}_x| > |\nu_t|$  then  $\Sigma$  is a *time-like surface* (in the given point).

*Remark 9.2.1.* Those who studied special relativity can explain (a) and (c).

## 9.2.3 Application to Cauchy problem

Consider now bounded domain  $\Omega$  bounded by  $\Sigma = \Sigma_+ \cup \Sigma_-$  where  $c|\boldsymbol{\nu}_x| \leq -\nu_t$  at each point of  $\Sigma_-$  and  $c|\boldsymbol{\nu}_x| \leq \nu_t$  at each point of  $\Sigma_+$ .

Assume that  $u$  satisfies (9.2.1) (that is  $u_{tt} - c^2\Delta u = 0$ ) and

$$u = u_t = 0 \quad \text{on } \Sigma_-. \quad (9.2.5)$$

Then (9.2.3) implies that

$$\iint_{\Sigma_+} \left( (u_t^2 + |\nabla u|^2)\nu_t - 2c^2u_t\nabla u \cdot \boldsymbol{\nu}_x \right) d\sigma = 0$$

which due to Statement (i) of Proposition 9.2.1 and assumption that  $c|\boldsymbol{\nu}_x| \leq \nu_t$  on  $\Sigma_+$  implies that the integrand is 0 and therefore  $u_t = \nabla u = 0$  in each point where  $c|\boldsymbol{\nu}_x| < \nu_t$ .

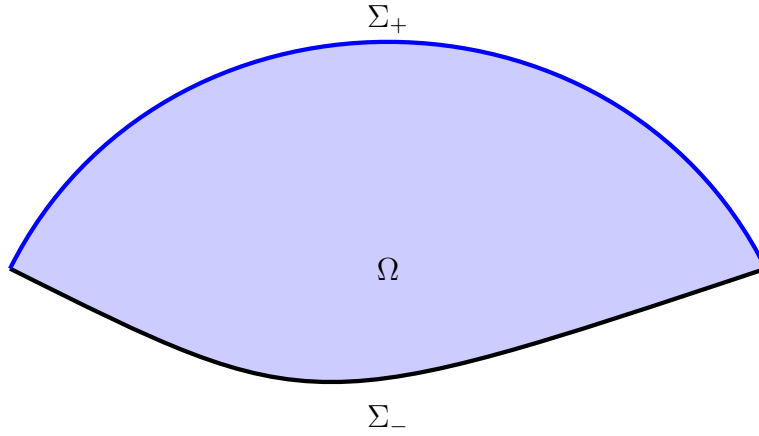

We can apply the same arguments to  $\Omega_T := \Omega \cap \{t < T\}$  with the boundary  $\Sigma_T = \Sigma \cap \{t < T\} \cup S_T$ ,  $S_T := \Omega \cap \{t = T\}$ ; note that on  $S_T$   $\nu_t = 1$ ,  $\nu_x = 0$ .

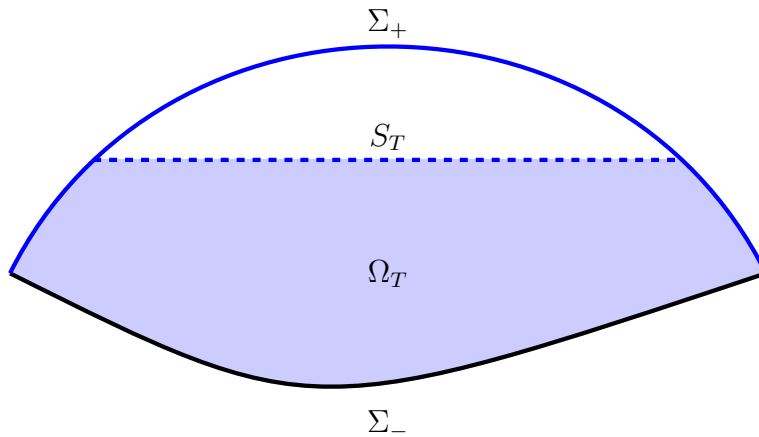

Therefore  $u_t = \nabla u = 0$  on  $S_T$  and since we can select  $T$  arbitrarily we conclude that this is true everywhere in  $\Omega$ . Since  $u = 0$  on  $\Sigma_-$  we conclude that  $u = 0$  in  $\Omega$ . So we proved:

**Theorem 9.2.2.** *Consider a bounded domain  $\Omega$  bounded by  $\Sigma = \Sigma_+ \cup \Sigma_-$  where  $c|\nu_x| \leq -\nu_t$  at each point of  $\Sigma_-$  and  $c|\nu_x| \leq \nu_t$  at each point of  $\Sigma_+$ .*



Assume that  $u$  satisfies

$$u_{tt} - c^2 \Delta u = 0, \quad (9.2.1)$$

$$u = u_t = 0 \quad \text{on } \Sigma_-. \quad (9.2.5)$$

Then  $u = 0$  in  $\Omega$ .

It allows us to prove

**Theorem 9.2.3.** Consider  $(y, \tau)$  with  $\tau > 0$  and let

$$K^-(y, \tau) = \{(x, t) : t \leq \tau, |y - x| < c(\tau - t)\}$$

be a backward light cone issued from  $(y, \tau)$ . Let

(a)  $u$  satisfy (9.2.1) in  $K^-(y, \tau) \cap \{t > 0\}$ ,

(b)  $u = u_t = 0$  at  $K^-(y, \tau) \cap \{t = 0\}$ .

Then  $u = 0$  in  $K^-(x, t) \cap \{t > 0\}$ .

*Proof.* Proof is obvious: we can use  $\Omega = K^-(x, t) \cap \{t > 0\}$ . Note that the border of  $K^-(x, t)$  is characteristic at each point and  $\nu_t > 0$ .  $\square$

## 9.2.4 Application to IBVP

Consider domain  $\mathcal{D} \subset \mathbb{R}^n$  with a boundary  $\Gamma$ .

**Theorem 9.2.4.** Consider  $(y, \tau)$  with  $\tau > 0$  and let  $K^-(y, \tau) = \{(x, t) : t \leq \tau, |y - x| < c(\tau - t)\}$  be a backward light cone issued from  $(y, \tau)$ . Let

(a)  $u$  satisfy (9.2.1) in  $K^-(y, \tau) \cap \{t > 0\} \cap \{x \in \mathcal{D}\}$ ,

(b)  $u = u_t = 0$  at  $K^-(y, \tau) \cap \{t = 0\} \cap \{x \in \mathcal{D}\}$ ,

(c) At each point of  $K^-(y, \tau) \cap \{t > 0\} \cap \{x \in \Gamma\}$  either  $u = 0$  or  $\frac{\partial u}{\partial \nu} = 0$  where  $\nu$  is a normal to  $\Gamma$ .

Then  $u = 0$  in  $K^-(y, \tau) \cap \{t > 0\} \cap \{x \in \mathcal{D}\}$ .

*Proof.* Proof uses the same energy approach but now we have also integral over part of the surface  $K^-(y, \tau) \cap \{t > 0\} \cap \{x \in \Gamma\}$  (which is time-like) but this integral is 0 due to Assumption (c).  $\square$

### 9.2.5 Remarks

*Remark 9.2.2.* The energy approach works in a very general framework and is used not only to prove uniqueness but also an existence and stability of solutions.

### Problems to Chapter 9

*Problem 1.* Solve as  $-\infty < t < \infty$

$$u_{tt} - \Delta u = 0,$$

with initial conditions

$$u(x, y, z, 0) = g(r)$$

$$u_t(x, y, z, 0) = h(r)$$

with  $r = \sqrt{x^2 + y^2 + z^2}$ .

*Hint.* Use spherical coordinates, observe that solution must be spherically symmetric:  $u = u(r, t)$  (explain why). Also, use equality

$$ru_{rr} + 2u_r = (ru)_{rr}.$$

$$(a) \begin{cases} g(x, y, z, 0) = \begin{cases} r^{-1} \sin(r) & r < \pi, \\ 0 & r \geq \pi, \end{cases} \\ h(x, y, z, 0) = 0. \end{cases}$$

$$(b) \begin{cases} g(x, y, z, 0) = 0, \\ h(x, y, z, 0) = \begin{cases} r^{-1} \sin(r) & r < \pi, \\ 0 & r \geq \pi. \end{cases} \end{cases}$$

$$(c) \begin{cases} g(x, y, z, 0) = \begin{cases} 1 - r^2 & r < 1, \\ 0 & r \geq 1, \end{cases} \\ h(x, y, z, 0) = 0. \end{cases}$$

$$(d) \begin{cases} g(x, y, z, 0) = 0, \\ h(x, y, z, 0) = \begin{cases} 1 - r^2 & r < 1, \\ 0 & r \geq 1. \end{cases} \end{cases}$$

$$(e) \begin{cases} g(x, y, z, 0) = \begin{cases} 1 - r & r < 1, \\ 0 & r \geq 1, \end{cases} \\ h(x, y, z, 0) = 0. \end{cases}$$

$$(f) \begin{cases} g(x, y, z, 0) = 0, \\ h(x, y, z, 0) = \begin{cases} 1 - r & r < 1, \\ 0 & r \geq 1. \end{cases} \end{cases}$$

$$(g) \begin{cases} g(x, y, z, 0) = \sin(r), \\ h(x, y, z, 0) = 0. \end{cases}$$

$$(k) \begin{cases} g(x, y, z, 0) = \cos(r), \\ h(x, y, z, 0) = 0. \end{cases}$$

$$(h) \begin{cases} g(x, y, z, 0) = 0, \\ h(x, y, z, 0) = \sin(r). \end{cases}$$

$$(l) \begin{cases} g(x, y, z, 0) = 0, \\ h(x, y, z, 0) = \cos(r). \end{cases}$$

$$(i) \begin{cases} g(x, y, z, 0) = r^{-1} \cos(r), \\ h(x, y, z, 0) = 0. \end{cases}$$

$$(m) \begin{cases} g(x, y, z, 0) = e^{-r}, \\ h(x, y, z, 0) = 0. \end{cases}$$

$$(j) \begin{cases} g(x, y, z, 0) = 0, \\ h(x, y, z, 0) = r^{-1} \cos(r). \end{cases}$$

$$(n) \begin{cases} g(x, y, z, 0) = 0, \\ h(x, y, z, 0) = e^{-r}. \end{cases}$$

# Chapter 10

## Variational methods

### 10.1 Functionals, extremums and variations

#### 10.1.1 Functionals: definitions

**Definition 10.1.1.** *Functional* is a map from some space of functions (or subset in the space of functions)  $\mathbf{H}$  to  $\mathbb{R}$  (or  $\mathbb{C}$ ):

$$\Phi : \mathbf{H} \ni u \rightarrow \Phi[u] \in \mathbb{R}. \quad (10.1.1)$$

*Remark 10.1.1.* Important that we consider *a whole function as an argument*, not its value at some particular point!

*Example 10.1.1.* (a) On the space  $C(I)$  of continuous functions on the closed interval  $I$  consider functional  $\Phi[u] = u(a)$  where  $a \in I$  (value at the point);

(b) On  $C(I)$  consider functionals  $\Phi[u] = \max_{x \in I} u(x)$ ,  $\Phi[u] = \min_{x \in I} u(x)$  and  $\Phi[u] = \max_{x \in I} |u(x)|$ ,  $\Phi[u] = \min_{x \in I} |u(x)|$ ;

(c) Consider  $\Phi[u] = \int_I f(x)u(x) dx$  where  $f(x)$  is some fixed function.

(d) On the space  $C^1(I)$  of continuous and continuously differentiable functions on the closed interval  $I$  consider functional  $\Phi[u] = u'(a)$ .

**Definition 10.1.2.** (a) Sum of functionals  $\Phi_1 + \Phi_2$  is defined as  $(\Phi_1 + \Phi_2)[u] = \Phi_1[u] + \Phi_2[u]$ ;

(b) Product of functional by a number:  $\lambda\Phi$  is defined as  $(\lambda\Phi)[u] = \lambda(\Phi[u])$ ;

(c) Function of functionals:  $F(\Phi_1, \dots, \Phi_s)$  is defined as  $F(\Phi_1, \dots, \Phi_s)[u] = F(\Phi_1[u], \dots, \Phi_s[u])$ .

**Definition 10.1.3.** Functional  $\Phi[u]$  is called *linear* if

$$\Phi[u + v] = \Phi[u] + \Phi[v], \quad (10.1.2)$$

$$\Phi[\lambda u] = \lambda \Phi[u] \quad (10.1.3)$$

for all functions  $u$  and scalars  $\lambda$ .

*Remark 10.1.2.* Linear functionals are crucial in the definition of *distributions* in Chapter 11.

*Exercise 10.1.1.* Which functionals of Example 10.1.1 are linear?

## 10.1.2 Variations of functionals: 1-variable

We start from the classical variational problems: a single real valued function  $q(t)$  of  $t \in [t_0, t_1]$ , then consider vector-valued function. This would lead us to ODEs (or their systems), and rightfully belongs to advanced ODE course.

Let us consider functional

$$S[q] = \int_I L(q(t), \dot{q}(t), t) dt \quad (10.1.4)$$

where in traditions of *Lagrangian mechanics* we interpret  $t \in I = [t_0, t_1]$  as a time,  $q(t)$  as a coordinate, and  $\dot{q}(t) := q'_t(t)$  as a velocity.

Let us consider  $q + \delta q$  where  $\delta q$  is a “small” function. We do not formalize this notion, just  $\delta q = \varepsilon \varphi$  with fixed  $\varphi$  and  $\varepsilon \rightarrow 0$  is considered to be small. We call  $\delta q$  *variation* of  $q$  and important is that *we change a function as a whole object*.

Let us consider

$$\begin{aligned} \delta S &:= S[q + \delta q] - S[q] = \int_I \left( L(q + \delta q, \dot{q} + \delta \dot{q}, t) - L(q, \dot{q}, t) \right) dt \\ &\approx \int_I \left( \frac{\partial L}{\partial q} \delta q + \frac{\partial L}{\partial \dot{q}} \delta \dot{q} \right) dt \end{aligned} \quad (10.1.5)$$

where we calculated the linear part of expression in the parenthesis; if  $\delta q = \varepsilon \varphi$  and all functions are sufficiently smooth then  $\approx$  would mean “equal modulo  $o(\varepsilon)$  as  $\varepsilon \rightarrow 0$ ”.

**Definition 10.1.4.** (a) Function  $L$  we call *Lagrangian*.

(b) The right-hand expression of (10.1.5) which is a linear functional with respect to  $\delta q$  we call *variation of functional*  $S$ .

*Assumption 10.1.1.* All functions are sufficiently smooth.

Under this assumption, we can integrate the right-hand expression of (10.1.5) by parts

$$\begin{aligned} \delta S &:= \int_I \left( \frac{\partial L}{\partial q} \delta q + \frac{\partial L}{\partial \dot{q}} \delta \dot{q} \right) dt \\ &= \int_I \left( \frac{\partial L}{\partial q} - \frac{d}{dt} \frac{\partial L}{\partial \dot{q}} \right) \delta q dt - \left( \frac{\partial L}{\partial \dot{q}} \right) \delta q \Big|_{t=t_0}^{t=t_1}. \end{aligned} \quad (10.1.6)$$

### 10.1.3 Stationary points of functionals

**Definition 10.1.5.** If  $\delta S = 0$  for all *admissible variations*  $\delta q$  we call  $q$  a *stationary point* or *extremal* of functional  $S$ .

*Remark 10.1.3.* (a) We consider  $q$  as a point in the functional space.

(b) In this definition we did not specify which variations are admissible. Let us consider as admissible all variations which are 0 at both ends of  $I$ :

$$\delta q(t_0) = \delta q(t_1) = 0. \quad (10.1.7)$$

In this framework

$$\delta S = \int_I \left( \frac{\partial L}{\partial q} - \frac{d}{dt} \frac{\partial L}{\partial \dot{q}} \right) \delta q dt. \quad (10.1.8)$$

**Lemma 10.1.1.** *Let  $f$  be a continuous function in  $I$ . If  $\int_I f(t)\varphi(t) dt = 0$  for all  $\varphi$  such that  $\varphi(t_0) = \varphi(t_1) = 0$  then  $f = 0$  in  $I$ .*

*Proof.* Indeed, let us assume that  $f(\bar{t}) > 0$  at some point  $\bar{t} \in I$  (case  $f(\bar{t}) < 0$  is analyzed in the same way). Then  $f(t) > 0$  in some vicinity  $\mathcal{V}$  of  $\bar{t}$ . Consider function  $\varphi(x)$  which is 0 outside of  $\mathcal{V}$ ,  $\varphi \geq 0$  in  $\mathcal{V}$  and  $\varphi(\bar{t}) > 0$ . Then  $f(t)\varphi(t)$  has the same properties and  $\int_I f(t)\varphi(t) dt > 0$ . Contradiction!  $\square$

As a corollary we arrive to

**Theorem 10.1.2.** *Let us consider a functional*

$$S[q] = \int_I L(q(t), \dot{q}(t), t) dt \quad (10.1.4)$$

*and consider as admissible all  $\delta u$  satisfying*

$$\delta q(t_0) = \delta q(t_1) = 0. \quad (10.1.7)$$

*Then  $u$  is a stationary point of  $\Phi$  if and only if it satisfies Euler-Lagrange equation*

$$\frac{\delta S}{\delta q} := \frac{\partial L}{\partial q} - \frac{d}{dt} \left( \frac{\partial L}{\partial \dot{q}} \right) = 0. \quad (10.1.9)$$

*Remark 10.1.4.* (a) Equation (10.1.9) is the 2nd order ODE. Indeed,

$$\frac{d}{dt} \frac{\partial L}{\partial \dot{q}} = \left( \frac{\partial^2 L}{\partial \dot{q} \partial t} + \frac{\partial^2 L}{\partial \dot{q} \partial q} \dot{q} + \frac{\partial^2 L}{\partial \dot{q}^2} \ddot{q} \right).$$

(b) If  $L_q = 0$  then it integrates to

$$\frac{\partial L}{\partial \dot{q}} = C. \quad (10.1.10)$$

(c) The following equality holds:

$$\frac{d}{dt} \left( \frac{\partial L}{\partial \dot{q}} \dot{q} - L \right) = -\frac{\partial L}{\partial t}. \quad (10.1.11)$$

The proof will be provided for vector-valued  $\mathbf{q}(t)$ .

(d) In particular, if  $\frac{\partial L}{\partial t} = 0$  ( $L$  does not depend explicitly on  $t$ ), then

$$\frac{d}{dt} \left( \frac{\partial L}{\partial \dot{q}} \dot{q} - L \right) = 0 \implies \frac{\partial L}{\partial \dot{q}} \dot{q} - L = C. \quad (10.1.12)$$

### 10.1.4 Extremums of functionals

**Definition 10.1.6.** If  $S[q] \geq S[q + \delta q]$  for all small admissible variations  $\delta q$  we call  $q$  a *local maximum* of functional  $S$ . If  $S[q] \leq S[q + \delta q]$  for all small admissible variations  $\delta q$  we call  $q$  a *local minimum* of functional  $S$ .

Here again we do not specify what is *small admissible variation*.

**Theorem 10.1.3.** *If  $q$  is a local extremum (that means either local minimum or maximum) of  $S$  and variation exists, then  $q$  is a stationary point.*

*Proof.* Consider case of minimum. Let  $\delta q = \varepsilon\varphi$ . Then

$$S[q + \delta q] - S[q] = \varepsilon(\delta S)(\varphi) + o(\varepsilon).$$

If  $\pm\delta S > 0$  then choosing  $\mp\varepsilon < 0$  we make  $\varepsilon(\delta S)(\varphi) \leq -\sigma\varepsilon$  with some  $\sigma > 0$ .

Meanwhile for sufficiently small  $\varepsilon$  “ $o(\varepsilon)$ ” is much smaller and  $S[q + \delta q] - S[q] \leq -2\sigma\varepsilon < 0$  and  $q$  is not a local minimum.  $\square$

*Remark 10.1.5.* (a) We used that  $\varepsilon$  can take both signs. If  $\varepsilon$  can be only positive or negative, then conclusion is wrong.

(b) We consider neither sufficient conditions of extremums nor *second variations* (similar to second differentials). In some cases they will be obvious.

*Example 10.1.2* (Brachistochrone). Find the line of the fastest descent from fixed point  $A$  to fixed point  $B$ .

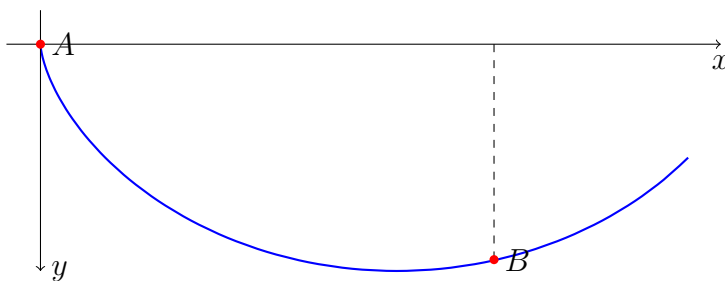

*Solution.* Assuming that the speed at  $A(0,0)$  is 0, we conclude that the speed at point  $(x,y)$  is  $\sqrt{2gy}$  and therefore the time of the descent from  $A$  to  $B(a,-h)$

$$T[y] = \int_0^a \frac{\sqrt{1 + y'^2} dx}{\sqrt{2gy}}.$$



Since  $L(y, y') := \frac{\sqrt{1+y'^2}}{\sqrt{2gy}}$  does not depend on  $x$  we use (10.1.12)

$$\begin{aligned} \frac{\partial L}{\partial y'} y' - L &= \frac{1}{\sqrt{1+y'^2} \sqrt{2gy}} = C \\ \implies y' &= \sqrt{\frac{D-y}{y}} \implies dx = \sqrt{\frac{y}{D-y}} dy \end{aligned}$$

with constants  $C$  and  $D$ . This equation has a solution

$$\begin{aligned} x &= r(\varphi - \sin(\varphi)), \\ y &= r(1 - \cos(\varphi)) \end{aligned}$$

with  $r = D/2$ . So, *brachistochrone is an inverted cycloid*—the curve traced by a point on a circle as it rolls along a straight line without slipping.  $\square$

## 10.2 Functionals, Eextremums and variations (continued)

### 10.2.1 Boundary conditions

Let us consider the same functional

$$S[q] = \int_I L(q(t), \dot{q}(t), t) dt \quad (10.1.4)$$

but now instead of constrain (10.1.7) ( $\delta q(t_0) = \delta q(t_1) = 0$ ) we put less restrictive

$$\delta q(t_0) = 0. \quad (10.2.1)$$

Then Euler-Lagrange equation

$$\frac{\delta S}{\delta q} := \frac{\partial L}{\partial q} - \frac{d}{dt} \left( \frac{\partial L}{\partial \dot{q}} \right) = 0 \quad (10.1.9)$$

must still be fulfilled but it does not guarantee that  $\delta S = 0$  for all admissible variations as according to (10.1.6)

$$\delta S = \frac{\partial L}{\partial \dot{q}} \delta q \Big|_{t=t_1}, \quad (10.2.2)$$

where we used Euler-Lagrange equation to eliminate integral term and (10.2.1) ( $\delta q(t_0) = 0$ ) to eliminate “left-end-term”.

Now we need to have it be 0 as well as since  $\delta q(t_1)$  is arbitrary we need

$$\left. \frac{\partial L}{\partial \dot{q}} \right|_{t=t_1} = 0. \quad (10.2.3)$$

However under assumption (10.2.1) it makes sense to consider more general functional than (10.1.4):

$$S[q] = \int_I L(q, \dot{q}, t) dt + M_1(q(t_1)), \quad (10.2.4)$$

which includes a *boundary term*. One can see easily that variation of the boundary term is  $\frac{\partial M_1}{\partial q} \delta q$  which should be added to the right-hand expression of (10.2.2) which becomes

$$\delta S = \left( \frac{\partial L}{\partial \dot{q}} + \frac{\partial M_1}{\partial q} \right) \delta q(t_1); \quad (10.2.5)$$

then (10.2.3) becomes

$$\left( \frac{\partial L}{\partial \dot{q}} + \frac{\partial M_1}{\partial q} \right) \Big|_{t=t_1} = 0. \quad (10.2.6)$$

Then we arrive to the following generalization of Theorem 10.1.2

**Theorem 10.2.1.** *Let us consider a functional*

$$S[q] = \int_I L(q, \dot{q}, t) dt + M_1(q(t_1)), \quad (10.2.4)$$

*and consider as admissible all  $\delta q$  satisfying (10.2.1) which is  $\delta q(t_0) = 0$ .*

*Then  $q$  is a stationary point of  $S$  if and only if it satisfies Euler-Lagrange equation*

$$\frac{\delta S}{\delta q} := \frac{\partial L}{\partial q} - \frac{d}{dt} \left( \frac{\partial L}{\partial \dot{q}} \right) = 0 \quad (10.1.9)$$

*and a boundary condition*

$$\left( \frac{\partial L}{\partial \dot{q}} + \frac{\partial M_1}{\partial q} \right) \Big|_{t=t_1} = 0. \quad (10.1.6)$$

*Example 10.2.1* ([Newton's minimal resistance problem](#)). Find the minimal resistance solid of revolution of the given diameter  $H$  and length  $a$ . Up to a numerical coefficient

$$S[y] := \int_0^a \frac{y \, dy}{1 + \left(\frac{dx}{dy}\right)^2} = \int_0^a \frac{yy'^3 \, dx}{1 + y'^2} + \frac{1}{2}y(a)^2$$

where the first term is the air resistance of the “side surface” obtained by revolution about  $x$  of the curve  $\{y = y(x), 0 < x < a\}$  and the second term is a resistance of the front disk of the radius  $y(a)$ .

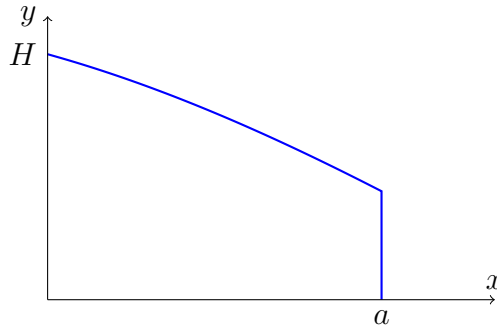

*Solution.*  $L(y, y') := \frac{yy'^3}{1 + y'^2}$  does not depend on  $x$  and using (10.1.2)

$$\begin{aligned} \frac{\partial L}{\partial y'} y' - L &= \frac{2yy'^3}{(1 + y'^2)^2} = -2C \implies y = C \frac{(1 + p^2)^2}{p^3}, \quad p := -y', \\ \implies dy &= C \left( -\frac{3}{p^4} - \frac{2}{p^2} + 1 \right) dp \implies dx = -\frac{dy}{p} = C \left( \frac{3}{p^5} + \frac{2}{p^3} - \frac{1}{p} \right) \\ &\implies x = -C \left( \frac{3}{4p^4} + \frac{1}{p^2} + \ln(p) \right) + C_2 \end{aligned}$$

which defines the curve parametrically.

Meanwhile  $y(0) = H$  and boundary condition (10.2.6) is equivalent to  $y'(a) = -1$  (so  $p$  ranges from some  $p_0 \in (0, 1)$  to  $p_1 = 1$ ).  $\square$

*Remark 10.2.1.* (a) If instead of (10.2.1) we consider restriction  $\delta q(t_1) = 0$  then (10.2.6) is replaced by

$$\left( \frac{\partial L}{\partial \dot{q}} - \frac{\partial M_0}{\partial q} \right) \Big|_{t=t_0} = 0. \quad (10.2.7)$$

(b) If we have no restrictions to  $\delta q(t_0)$ ,  $\delta q(t_1)$ , then we have both (10.2.6) and (10.2.7).

(c) Thus, no matter what, we have on each endpoint one condition: either  $q(t_0) = q^0$  or (10.2.7) at  $t = t_0$ , and either  $q(t_1) = q^1$  or (10.2.6) at  $t = t_1$ .

## 10.2.2 Vector and complex valued functions

If our function is vector-valued:  $\mathbf{q} = (q_1, \dots, q_m)$ , then we can consider variations with respect to different components and derive corresponding Euler-Lagrange equations

$$\frac{\partial L}{\partial q_k} - \frac{d}{dt} \frac{\partial L}{\partial \dot{q}_k} = 0 \quad k = 1, \dots, m. \quad (10.2.8)$$

We also get  $m$  boundary conditions on each endpoint of the interval.

*Remark 10.2.2.* (a) If  $L_{q_k} = 0$  then the corresponding equation integrates to

$$\frac{\partial L}{\partial \dot{q}} = C_k. \quad (10.2.9)$$

(b) The following equality holds (*Beltrami identity*):

$$\frac{d}{dt} \left( \sum_{1 \leq k \leq m} \frac{\partial L}{\partial \dot{q}_k} \dot{q}_k - L \right) = -\frac{\partial L}{\partial t}. \quad (10.2.10)$$

Indeed, the left hand expression equals to

$$\sum_{1 \leq k \leq m} \left[ \left( \frac{d}{dt} \frac{\partial L}{\partial \dot{q}_k} \right) \dot{q}_k + \frac{\partial L}{\partial \dot{q}_k} \ddot{q}_k \right] - \sum_{1 \leq k \leq m} \left[ \frac{\partial L}{\partial q_k} \dot{q}_k + \frac{\partial L}{\partial \dot{q}_k} \ddot{q}_k \right] - \frac{\partial L}{\partial t},$$

where to differentiate  $L$  we used a chain rule. Second terms in both brackets cancel immediately, first terms in both brackets also cancel due to Euler-Lagrange equations, and we are left with  $-\frac{\partial L}{\partial t}$ .

(c) In particular, if  $\frac{\partial L}{\partial t} = 0$  ( $L$  does not depend explicitly on  $t$ ), then

$$\frac{d}{dt} \left( \sum_{1 \leq k \leq m} \frac{\partial L}{\partial \dot{q}_k} \dot{q}_k - L \right) = 0 \implies \sum_{1 \leq k \leq m} \frac{\partial L}{\partial \dot{q}_k} \dot{q}_k - L = C. \quad (10.2.11)$$

*Remark 10.2.3.* Complex-valued functions  $q$  could be considered as vector-valued functions  $\mathbf{q} = \begin{pmatrix} \operatorname{Re}(q) \\ \operatorname{Im}(q) \end{pmatrix}$ . Similarly we can treat functions which are vector-valued with complex components: we just double  $m$ .

### 10.2.3 Extremals under constrains. I

We can consider extremals of functionals under constrains

$$\Psi_1[q] = \Psi_2[q] = \dots = \Psi_s[q] = 0 \quad (10.2.12)$$

where  $\Psi_j$  are other functionals. This is done in the same way as for extremums of functions of several variables: instead of  $S[q]$  we consider *Lagrange functional*

$$S^*[q] := S[q] - \lambda_1 \Psi_1[q] - \lambda_2 \Psi_2[q] - \dots - \lambda_s \Psi_s[q] \quad (10.2.13)$$

and look for it extremals without constrains; factors  $\lambda_1, \dots, \lambda_s$  are *Lagrange multipliers*.

*Remark 10.2.4.* This works provided  $\delta\Psi_1, \dots, \delta\Psi_s$  are *linearly independent* which means that if  $\alpha_1 \delta\Psi_1[q] + \alpha_2 \delta\Psi_2[q] + \dots + \alpha_s \delta\Psi_s[q] = 0$  for all admissible  $\delta q$ , then  $\alpha_1 = \dots = \alpha_s = 0$ .

*Example 10.2.2 (Catenary).* Find the curve that an idealized chain (infinitely flexible but unstretchable) hanging between two anchors takes.

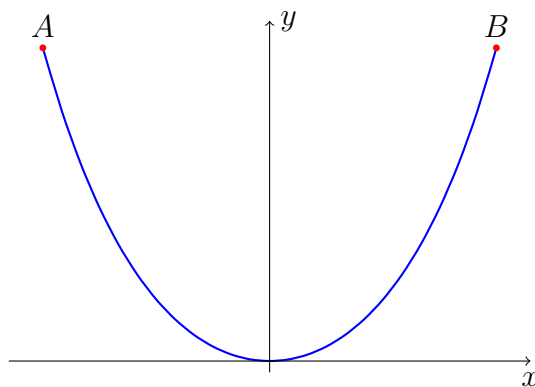

*Solution.* We need to minimize potential energy

$$E[y] = g \int_0^a y \sqrt{1 + y'^2} dx$$

under constrain

$$\ell[y] = \int_0^a \sqrt{1 + y'^2} dx = l.$$

Then  $L^*(y, y') := (y - \lambda)\sqrt{1 + y'^2}$  does not depend on  $x$  and using (10.1.2)

$$\begin{aligned} \frac{\partial L^*}{\partial y'} y' - L^* &= \frac{y - \lambda}{\sqrt{1 + y'^2}} = C \implies ay' = \sqrt{(y - \lambda)^2 - a^2} \\ \implies dx &= \frac{a dy}{\sqrt{(y - \lambda)^2 - a^2}} \implies y - \lambda = a \cosh((x - c)/a) \end{aligned}$$

with constants  $a, c, \lambda$ . □

### 10.2.4 Extremals under constrains. II

However constrains could be different from those described in the previous subsection. They can be not in the form of functionals but in the form of functions. In this case we have continuum conditions and Lagrange multipliers became functions as well. Let us consider this on an example.

*Example 10.2.3.* Consider our standard functional under constrains

$$F_j(\mathbf{q}(t), t) = 0 \quad j = 1, \dots, s. \quad (10.2.14)$$

Then we consider functional

$$S^*[\mathbf{q}] = \int_I (L(\mathbf{q}, \dot{\mathbf{q}}, t) - \sum_{1 \leq j \leq s} \lambda_j(t) F_j(\mathbf{q}(t), t)) dt.$$

*Solution.* Then Euler-Lagrange equations are

$$\frac{\partial L}{\partial q_k} - \frac{d}{dt} \frac{\partial L}{\partial \dot{q}_k} - \sum_{1 \leq j \leq s} \lambda_j(t) \frac{\partial F_j}{\partial q_k} = 0 \quad (10.2.15)$$

with unknown functions  $\lambda_j(t)$ . □

*Remark 10.2.5.* Obviously we can combine different types of constrains and different types of Lagrange multipliers.

### 10.2.5 Higher order functionals

We could include into functional higher-order derivatives. Let us consider functional (for simplicity we consider scalar functions and second-order )

$$S[q] = \int_I L(q, \dot{q}, \ddot{q}, t) dt. \quad (10.2.16)$$

Then the same arguments as before (but term  $\frac{\partial L}{\partial \ddot{q}} \delta \ddot{q}$  should be integrated by parts twice) lead us to Euler-Lagrange equation

$$\frac{\delta S}{\delta q} := \frac{\partial L}{\partial q} - \frac{d}{dt} \left( \frac{\partial L}{\partial \dot{q}} \right) + \frac{d^2}{dt^2} \left( \frac{\partial L}{\partial \ddot{q}} \right) = 0 \quad (10.2.17)$$

which is the fourth order ODE.

But what about boundary conditions? We need to have now *two of them at each endpoint*. Consider, f.e.  $t = t_1$ . Then we have there in  $\delta S$  terms

$$\left[ \left( -\frac{d}{dt} \frac{\partial L}{\partial \ddot{q}} + \frac{\partial L}{\partial \dot{q}} + \frac{\partial M_1}{\partial q} \right) \delta q + \left( \frac{\partial L}{\partial \ddot{q}} + \frac{\partial M_1}{\partial \dot{q}} \right) \delta \dot{q} \right] \Big|_{t=t_1}, \quad (10.2.18)$$

if functional includes a term  $M_1(q(t_1), \dot{q}(t_1))$ .

Obviously we have them if we are looking for solution satisfying

$$q(t_1) = a, \quad \dot{q}(t_1) = b. \quad (10.2.19)$$

Otherwise we need to consider  $\delta S$ . If we have only the first restriction, then  $\delta q(t_1) = 0$ , but  $\delta \dot{q}(t_1)$  is arbitrary and we get the second boundary condition

$$\left( \frac{\partial L}{\partial \ddot{q}} + \frac{\partial M_1}{\partial \dot{q}} \right) \Big|_{t=t_1} = 0. \quad (10.2.20)$$

If there are no restriction,  $\delta q(t_1)$  is also arbitrary and in addition to (10.2.20) we get

$$\left( -\frac{d}{dt} \frac{\partial L}{\partial \ddot{q}} + \frac{\partial L}{\partial \dot{q}} + \frac{\partial M_1}{\partial q} \right) \Big|_{t=t_1} = 0. \quad (10.2.21)$$

We can also consider more general case of one restriction leading to  $[\alpha \delta q + \beta \delta \dot{q}](t_1) = 0$  with  $(\alpha, \beta) \neq 0$  and recover the second condition.

## 10.3 Functionals, extremums and variations (multidimensional)

### 10.3.1 Variations of functionals

Now we consider functionals, defined on functions of several variables.

Let us consider functional

$$\Phi[u] = \iiint_{\Omega} L(x, u, \nabla u) dx \quad (10.3.1)$$

where  $\Omega$  is  $n$ -dimensional domain and  $L$  is some function of  $n + 2$  variables. Let us consider  $u + \delta u$  where  $\delta u$  is a “small” function. We do not formalize this notion, just  $\varepsilon\phi$  with fixed  $\phi$  and  $\varepsilon \rightarrow 0$  is considered to be small. We call  $\delta u$  *variation* of  $u$  and important is that we change a function as a whole object.

Let us consider

$$\begin{aligned} \Phi[u + \delta u] - \Phi[u] &= \iiint_{\Omega} \left( L(x, u + \delta u, \nabla u + \nabla \delta u) - L(x, u, \nabla u) \right) dx \\ &\approx \iiint_{\Omega} \left( \frac{\partial L}{\partial u} \delta u + \sum_{1 \leq j \leq n} \frac{\partial L}{\partial u_{x_j}} \delta u_{x_j} \right) dx \end{aligned} \quad (10.3.2)$$

where we calculated the linear part of expression in the parenthesis; if  $\delta u = \varepsilon\phi$  and all functions are sufficiently smooth then  $\approx$  would mean “equal modulo  $o(\varepsilon)$  as  $\varepsilon \rightarrow 0$ ”.

**Definition 10.3.1.** 1. Function  $L$  we call *Lagrangian*.

2. The right-hand expression of (10.3.2) which is a linear functional with respect to  $\delta u$  we call *variation of functional*  $\Phi$  and denote by  $\delta\Phi$ .

*Assumption 10.3.1.* All functions are sufficiently smooth.

Under this assumption, we can integrate the right-hand expression of (10.3.2) by parts:

$$\begin{aligned} \delta\Phi &:= \iiint_{\Omega} \left( \frac{\partial L}{\partial u} \delta u + \sum_{1 \leq j \leq n} \frac{\partial L}{\partial u_{x_j}} \delta u_{x_j} \right) dx \\ &= \iiint_{\Omega} \left( \frac{\partial L}{\partial u} - \sum_{1 \leq j \leq n} \frac{\partial}{\partial x_j} \frac{\partial L}{\partial u_{x_j}} \right) \delta u \, dx - \iint_{\partial\Omega} \left( \sum_{1 \leq j \leq n} \frac{\partial L}{\partial u_{x_j}} \nu_j \right) \delta u \, d\sigma \end{aligned} \quad (10.3.3)$$

where  $d\sigma$  is an area element and  $\nu$  is a unit interior normal to  $\partial\Omega$ .

## 10.3.2 Stationary points of functionals

**Definition 10.3.2.** If  $\delta\Phi = 0$  for all *admissible variations*  $\delta u$  we call  $u$  a *stationary point* or *extrema* of functional  $\Phi$ .

*Remark 10.3.1.* (a) We consider  $u$  as a point in the functional space.



(b) In this definition we did not specify which variations are admissible. Let us consider as admissible all variations which are 0 at the boundary:

$$\delta u|_{\partial\Omega} = 0. \quad (10.3.4)$$

We will consider different admissible variations later.

In this framework

$$\delta\Phi = \iiint_{\Omega} \left( \frac{\partial L}{\partial u} - \sum_{1 \leq j \leq n} \frac{\partial}{\partial x_j} \frac{\partial L}{\partial u_{x_j}} \right) \delta u \, dx. \quad (10.3.5)$$

**Lemma 10.3.1.** *Let  $f$  be a continuous function in  $\Omega$ . If  $\iiint_{\Omega} f(x)\phi(x) \, dx = 0$  for all  $\phi$  such that  $\phi|_{\partial\Omega} = 0$  then  $f = 0$  in  $\Omega$ .*

*Proof.* Indeed, let us assume that  $f(\bar{x}) > 0$  at some point  $\bar{x} \in \Omega$  (case  $f(\bar{x}) < 0$  is analyzed in the same way). Then  $f(x) > 0$  in some vicinity  $\mathcal{V}$  of  $\bar{x}$ .

Consider function  $\phi(x)$  which is 0 outside of  $\mathcal{V}$ ,  $\phi \geq 0$  in  $\mathcal{V}$  and  $\phi(\bar{x}) > 0$ . Then  $f(x)\phi(x)$  has the same properties and  $\iiint_{\Omega} f(x)\phi(x) \, dx > 0$ . Contradiction!  $\square$

As a corollary we arrive to

**Theorem 10.3.2.** *Let us consider a functional*

$$\Phi[u] = \iiint_{\Omega} L(x, u, \nabla u) \, dx \quad (10.3.4)$$

and consider as admissible all  $\delta u$  satisfying (10.3.4) which is  $\delta u|_{\partial\Omega} = 0$ . Then  $u$  is a stationary point of  $\Phi$  if and only if it satisfies Euler-Lagrange equation

$$\frac{\delta\Phi}{\delta u} := \frac{\partial L}{\partial u} - \sum_{1 \leq j \leq n} \frac{\partial}{\partial x_j} \left( \frac{\partial L}{\partial u_{x_j}} \right) = 0. \quad (10.3.6)$$

*Remark 10.3.2.* (a) This is a second order PDE.

(b) We do not have statements similar to those in one-dimensional case as in Remark 10.1.4, Statements (b)–(d). See also Remark 10.2.2.

### 10.3.3 Extremums of functionals

**Definition 10.3.3.** If  $\Phi[u] \geq \Phi[u + \delta u]$  for all small admissible variations  $\delta u$  we call  $u$  a *local maximum* of functional  $\Phi$ . If  $\Phi[u] \leq \Phi[u + \delta u]$  for all small admissible variations  $\delta u$  we call  $u$  a *local minimum* of functional  $\Phi$ .

Here again we do not specify what is *small admissible variation*.

**Theorem 10.3.3.** *If  $u$  is a local extremum (that means either local minimum or maximum) of  $\Phi$  and variation exists, then  $u$  is a stationary point.*

*Proof.* Consider case of minimum. Let  $\delta u = \varepsilon\phi$ . Then

$$\Phi[u + \delta u] - \Phi[u] = \varepsilon(\delta\Phi)(\phi) + o(\varepsilon).$$

If  $\pm\delta\Phi > 0$  then choosing  $\mp\varepsilon < 0$  we make  $\varepsilon(\delta\Phi)(\phi) \leq -2\varepsilon_0\varepsilon$  with some  $\varepsilon_0 > 0$ . Meanwhile for sufficiently small  $\varepsilon$  " $o(\varepsilon)$ " is much smaller and  $\Phi[u + \delta u] - \Phi[u] \leq -\varepsilon_0\varepsilon < 0$  and  $u$  is not a local minimum.  $\square$

*Remark 10.3.3.* We consider neither sufficient conditions of extremums nor *second variations* (similar to second differentials). In some cases they will be obvious.

*Example 10.3.1.* (a) Consider a surface  $\Sigma = \{(x, y, z) : (x, y) \in \Omega, z = u(x, y)\}$  which has  $(x, y)$ -projection  $\Omega$ . Then the surface area of  $\Sigma$  is

$$A(\Sigma) = \iint_{\Omega} (1 + u_x^2 + u_y^2)^{\frac{1}{2}} dx dy. \quad (10.3.7)$$

We are interested in such surface of minimal area (a.k.a. *minimal surface*) under restriction  $u = g$  at points  $\partial\Omega$ . It is a famous [minimal surface problem](#) (under the assumption that it projects nicely on  $(x, y)$ -plane (which is not necessarily the case). One can formulate it: find the shape of the soap film on the wire.

Then Euler-Lagrange equation is

$$-\frac{\partial}{\partial x} \left( u_x (1 + u_x^2 + u_y^2)^{-\frac{1}{2}} \right) - \frac{\partial}{\partial y} \left( u_y (1 + u_x^2 + u_y^2)^{-\frac{1}{2}} \right) = 0. \quad (10.3.8)$$

(b) Assuming that  $u_x, u_y \ll 1$  one can approximate  $A(\Sigma) - A(\Omega)$  by

$$\frac{1}{2} \iint_{\Omega} (u_x^2 + u_y^2) dx dy \quad (10.3.9)$$

and for this functional Euler-Lagrange equation is

$$-\Delta u = 0. \quad (10.3.10)$$

(c) Both (a) and (b) could be generalized to higher dimensions.

*Remark 10.3.4.* Both variational problem and equation come with the boundary condition  $u|_{\partial\Omega} = g$ . In the next section we analyze the case when such condition is done in the original variational problem only on the part of the boundary.

## 10.4 Functionals, extremums and variations (multidimensional, continued)

### 10.4.1 Boundary conditions

Let us consider functional (10.3.1) but now instead of constrain (10.3.4) (which is  $\delta u|_{\partial\Omega} = 0$ ) we put a less restrictive

$$\delta u|_{\Sigma} = 0 \quad (10.4.1)$$

where  $\Sigma \subset \partial\Omega$  (may be even empty). Then Euler-Lagrange equation (10.3.6) must still be fulfilled but it does not guarantee that  $\delta\Phi = 0$  for all admissible variations as according to (10.3.3)

$$\delta\Phi = \iint_{\Sigma'} \left( - \sum_{1 \leq j \leq n} \frac{\partial L}{\partial u_{x_j}} \nu_j \right) \delta u \, d\sigma \quad (10.4.2)$$

where  $\Sigma' = \partial\Omega \setminus \Sigma$ : the part of  $\partial\Omega$  complementary to  $\Sigma$ .

Now we need to have it be 0 as well as since  $\delta u$  is arbitrary there according to Lemma 10.3.1 we need to have expression in parenthesis vanish:

$$\left( - \sum_{1 \leq j \leq n} \frac{\partial L}{\partial u_{x_j}} \nu_j \right) \Big|_{\Sigma'} = 0. \quad (10.4.3)$$

However under Assumption 10.1.1 it makes sense to consider more general functional than (10.3.1):

$$\Phi[u] = \iiint_{\Omega} L(x, u, \nabla u) \, dx + \underbrace{\iint_{\Sigma'} M(x, u) \, d\sigma}_{\text{boundary term}} \quad (10.4.4)$$

which includes a *boundary term*. One can see easily that variation of the boundary term is  $\iint_{\Sigma'} \frac{\partial M}{\partial u} \delta d\sigma$  which should be added to (10.4.2) which becomes

$$\delta\Phi = \iint_{\partial\Sigma'} \left( - \sum_{1 \leq j \leq n} \frac{\partial L}{\partial u_{x_j}} \nu_j + \frac{\partial M}{\partial u} \right) \delta u d\sigma; \quad (10.4.5)$$

then (10.4.3) becomes

$$\left( - \sum_{1 \leq j \leq n} \frac{\partial L}{\partial u_{x_j}} \nu_j + \frac{\partial M}{\partial u} \right) \Big|_{\Sigma'} = 0. \quad (10.4.6)$$

Then we arrive to the following generalization of Theorem 10.3.2:

**Theorem 10.4.1.** *Let us consider a functional (10.4.4) and consider as admissible all  $\delta u$  satisfying (10.4.1) on the part of the boundary. Then  $u$  is a stationary point of  $\Phi$  if and only if it satisfies Euler-Lagrange equation (10.3.6) and a boundary condition (10.4.6) on the remaining part of the boundary.*

*Example 10.4.1.* Consider

$$\iiint_{\Omega} \left( \frac{1}{2} |\nabla u|^2 - f(x)u \right) d^n x + \iint_{\Sigma'} \left( \frac{1}{2} \alpha(x) |u|^2 - h(x)u \right) d\sigma \quad (10.4.7)$$

under assumption

$$u|_{\Sigma} = g. \quad (10.4.8)$$

Then we have equation

$$\Delta u = -f \quad (10.4.9)$$

with the boundary condition (10.4.8) on  $\Sigma$  and

$$\left( \frac{\partial u}{\partial \nu} - \alpha u \right) \Big|_{\Sigma'} = -h \quad (10.4.10)$$

on  $\Sigma'$ . So at each point of the boundary we have exactly one condition.

Observe that (10.4.10) is Robin condition (Neumann condition as  $\alpha = 0$ ).

### 10.4.2 Vector and complex valued functions

If our function  $u(x)$  is vector-valued:  $u = (u_1, \dots, u_m)$  then we can consider variations with respect to different components and derive corresponding equations

$$\frac{\partial L}{\partial u_k} - \sum_{1 \leq j \leq n} \frac{\partial}{\partial x_j} \frac{\partial L}{\partial u_{k,x_j}} = 0 \quad k = 1, \dots, m. \quad (10.4.11)$$

We also get boundary conditions.

*Example 10.4.2.* (a) Consider functional

$$\Phi[\mathbf{u}] = \frac{1}{2} \iiint_{\Omega} \left( \alpha |\nabla \otimes \mathbf{u}|^2 + \beta |\nabla \cdot \mathbf{u}|^2 \right) dx \quad (10.4.12)$$

with  $\mathbf{u} = (u_1, \dots, u_n)$ ,  $|\nabla \otimes \mathbf{u}|^2 = \sum_{j,k} |u_{k,x_j}|^2$ ,  $\nabla \cdot \mathbf{u} = \sum_j u_{j,x_j}$ .

Then as  $\delta \mathbf{u} = 0$  on  $\partial\Omega$

$$\delta\Phi = \iiint_{\Omega} \left( -\alpha(\Delta \mathbf{u}) - \beta \nabla(\nabla \cdot \mathbf{u}) \right) \cdot \delta \mathbf{u} dx \quad (10.4.13)$$

where for simplicity we assume that  $\alpha$  and  $\beta$  are constant and we have a system

$$-\alpha \Delta \mathbf{u} - \beta \nabla(\nabla \cdot \mathbf{u}) = 0. \quad (10.4.14)$$

(b) Then for this functional

$$\delta\Phi = - \iint_{\Sigma'} \left( \alpha \frac{\partial \mathbf{u}}{\partial \boldsymbol{\nu}} + \beta(\nabla \cdot \mathbf{u}) \boldsymbol{\nu} \right) \cdot \delta \mathbf{u} d\sigma = 0 \quad (10.4.15)$$

with  $\frac{\partial \mathbf{u}}{\partial \boldsymbol{\nu}} := \sum_j \nu_j \frac{\partial \mathbf{u}}{\partial x_j}$ . Then if we assume that  $\delta \mathbf{u}$  on  $\Sigma'$  can be arbitrary, we arrive to boundary condition

$$\alpha \frac{\partial \mathbf{u}}{\partial \boldsymbol{\nu}} + \beta(\nabla \cdot \mathbf{u}) \boldsymbol{\nu} = 0. \quad (10.4.16)$$

(c) However there could be other “natural” conditions on  $\Sigma'$ . F.e. if we assume that  $\delta \mathbf{u} \parallel \boldsymbol{\nu}$  on  $\Sigma'$  we get

$$\left( \alpha \frac{\partial \mathbf{u}}{\partial \boldsymbol{\nu}} + \beta(\nabla \cdot \mathbf{u}) \boldsymbol{\nu} \right) \cdot \boldsymbol{\nu} = 0; \quad (10.4.17)$$

if we assume instead that  $\delta \mathbf{u} \cdot \boldsymbol{\nu} = 0$  we get

$$\frac{\partial \mathbf{u}}{\partial \boldsymbol{\nu}} \parallel \boldsymbol{\nu}. \quad (10.4.18)$$

Here and everywhere  $\parallel$  means parallel (proportional).

*Remark 10.4.1.* Complex-valued functions  $u$  could be considered as vector-valued functions  $\mathbf{u} = \begin{pmatrix} \operatorname{Re}(u) \\ \operatorname{Im}(u) \end{pmatrix}$ . Similarly we can treat functions which are vector-valued with complex components: we just double  $m$ .

### 10.4.3 Extremums under constrains. I

We can consider extremals of functionals under constrains

$$\Psi_1[u] = \Psi_2[u] = \dots = \Psi_s[u] = 0 \quad (10.4.19)$$

where  $\Psi_j$  are other functionals. This is done in the same way as for extremums of functions of several variables: instead of  $\Phi[u]$  we consider *Lagrange functional*

$$\Phi^*[u] := \Phi[u] - \lambda_1 \Psi_1[u] - \lambda_2 \Psi_2[u] - \dots - \lambda_s \Psi_s[u] \quad (10.4.20)$$

and look for it extremals without constrains; factors  $\lambda_1, \dots, \lambda_s$  are *Lagrange multipliers*.

*Remark 10.4.2.* This works provided  $\delta \Psi_1, \dots, \delta \Psi_s$  are *linearly independent* which means that if  $\alpha_1 \delta \Psi_1[u] + \alpha_2 \delta \Psi_2[u] + \dots + \alpha_s \delta \Psi_s[u] = 0$  for all admissible  $\delta u$  then  $\alpha_1 = \dots = \alpha_s = 0$ .

*Example 10.4.3.* (a) Let us consider

$$\Phi[u] := \frac{1}{2} \int |\nabla u|^2 dx \quad (10.4.21)$$

under constrains

$$\Psi[u] := \frac{1}{2} \int |u|^2 dx \quad (10.4.22)$$

and  $u|_{\partial\Omega} = 0$ . Then  $\Phi^*[u] = \frac{1}{2} \int (|\nabla u|^2 - \lambda |u|^2) dx$  and Euler-Lagrange equation is

$$-\Delta u = \lambda u; \quad (10.4.23)$$

so  $\lambda$  and  $u$  must be eigenvalue and eigenfunction of  $-\Delta$  (with Dirichlet boundary conditions. However only the lowest (base) eigenvalue  $\lambda_1$  delivers minimum.

(b) To deal with the the next eigenvalues and eigenfunctions let us assume that we got  $\lambda_1, \dots, \lambda_{s-1}$  and orthogonal  $u_1, \dots, u_{s-1}$  and let us consider constrains (10.4.22) and

$$(u, u_1) = (u, u_2) = \dots = (u, u_{s-1}) = 0 \quad (10.4.24)$$

where  $(u, v) = \iint_{\Omega} uv \, dx$  is an inner product (we consider real-valued functions). Then

$$\Phi^*[u] = \frac{1}{2} \int (|\nabla u|^2 - \lambda|u|^2 - 2\mu_1 u_1 u - \dots - 2\mu_{s-1} u_{s-1} u) \, dx$$

and we arrive to equation

$$-\Delta u - \lambda u - \mu_1 u_1 - \dots - \mu_{s-1} u_{s-1} = 0. \quad (10.4.25)$$

Taking an inner product with  $u_k$  we arrive to

$$-((\Delta + \lambda)u, u_k) - \mu_k \|u_k\|^2 = 0$$

because we know that  $u_1, \dots, u_{s-1}$  are orthogonal. Further,  $((\Delta + \lambda)u, u_k) = (u, (\Delta + \lambda)u_k) = (u, (-\lambda_k + \lambda)u_k) = 0$  and we conclude that  $\mu_k = 0$ . Then (10.4.24) implies

$$-\Delta u - \lambda u = 0 \quad (10.4.26)$$

and we got the next eigenvalue and eigenfunction.

(c) The same analysis works for Neumann and Robin boundary conditions (but we need to assume that  $\alpha \geq 0$  or at least is not “too negative”).

#### 10.4.4 Extremums under constrains. II

However constrains could be different from those described in the previous subsection. They can be not in the form of functionals but in the form of functions. In this case we have continuum conditions and Lagrange multipliers became functions as well. Let us consider this on examples.

*Example 10.4.4.* Consider  $\mathbf{u}$  as in Example 10.4.2 and functional

$$\Phi[u] = \frac{1}{2} \iiint_{\Omega} |\nabla \otimes \mathbf{u}|^2 \, dx \quad (10.4.27)$$

under constrain

$$\nabla \cdot \mathbf{u} = 0. \quad (10.4.28)$$

Then we consider functional

$$\Phi[u] = \iiint_{\Omega} \left( \frac{1}{2} |\nabla \otimes \mathbf{u}|^2 - \lambda(x) \nabla \cdot \mathbf{u} \right) dx = \iiint_{\Omega} \left( \frac{1}{2} |\nabla \otimes \mathbf{u}|^2 + \nabla \lambda(x) \cdot \mathbf{u} \right) dx$$

where we integrated by parts and ignored boundary term since here we are interested only in equation rather than boundary conditions. Then Euler-Lagrange equation is

$$\Delta \mathbf{u} = \nabla \lambda \quad (10.4.29)$$

with unknown function  $\lambda$ . However the right-hand expression is not an arbitrary vector-valued function but a gradient of some scalar function. Applying  $\nabla \cdot$  to (10.4.29) and using (10.4.28) we conclude that  $\Delta \lambda = 0$  so  $\lambda$  is a harmonic function.

*Example 10.4.5.* Example 10.4.3 could be considered in the same way. Indeed, let us consider constrain  $\mathbf{u} \cdot \boldsymbol{\nu} = 0$  at  $\Sigma'$ . Then we need to consider functional  $\Phi^*[u] = \Phi[u] - \iint_{\Sigma'} \lambda(x) \mathbf{u} \cdot \boldsymbol{\nu} d\sigma$  where  $\Phi[u]$  is defined by (10.4.12) and  $\lambda$  is unknown function on  $\Sigma'$ . We arrive to the same equation (10.4.14) but now (10.4.15) becomes

$$\delta \Phi = - \iint_{\Sigma'} \left( \alpha \frac{\partial \mathbf{u}}{\partial \boldsymbol{\nu}} + \underbrace{(\lambda + \beta \nabla \cdot \mathbf{u})}_{\text{highlighted}} \boldsymbol{\nu} \right) \cdot \delta \mathbf{u} d\sigma = 0$$

and we have no constrains to  $\delta \mathbf{u}$  on  $\Sigma'$  and we arrive to condition that expression in the parenthesis is 0 at  $\Sigma'$ . Since  $\lambda$  and thus highlighted expression are arbitrary functions on  $\Sigma'$  we arrive exactly to (10.4.18).

*Remark 10.4.3.* Obviously we can combine different types of constrains and different types of Lagrange multipliers.

## 10.4.5 Higher order functionals

We could include into functional higher-order derivatives. Let us consider functional

$$\Phi[u] = \iiint_{\Omega} L(x, u, \nabla u, \nabla^{(2)} u) dx \quad (10.4.30)$$



where  $\nabla^{(2)}u$  is a set of all derivatives  $u_{x_i x_j}$  with  $i \leq j$  (think why). Then the same arguments as before lead us to Euler-Lagrange equation

$$\frac{\delta\Phi}{\delta u} := \frac{\partial L}{\partial u} - \sum_{1 \leq j \leq n} \frac{\partial}{\partial x_j} \left( \frac{\partial L}{\partial u_{x_j}} \right) + \sum_{1 \leq i \leq j \leq n} \frac{\partial^2}{\partial x_i \partial x_j} \left( \frac{\partial L}{\partial u_{x_i x_j}} \right) = 0. \quad (10.4.31)$$

But what about boundary conditions? We need to have now two of them at each point. Obviously we have them if we are looking for solution satisfying

$$u|_{\partial\Omega} = g(x), \quad \frac{\partial u}{\partial \boldsymbol{\nu}}|_{\partial\Omega} = h(x). \quad (10.4.32)$$

Otherwise we need to consider  $\delta\Phi$ . We consider this only on example.

*Example 10.4.6.* Let

$$\Phi[u] = \frac{1}{2} \iiint_{\Omega} \left( \sum_{i,j} |u_{x_i x_j}|^2 \right) dx. \quad (10.4.33)$$

where we sum with respect to all pairs  $i, j$  (so  $|u_{x_i x_j}|^2$  with  $i \neq j$  is added twice). Then equation is

$$\Delta^2 u = 0 \quad (10.4.34)$$

(so  $u$  is *biharmonic function*) and

$$\delta\Phi = \iint_{\Sigma'} \left( - \sum_{i,j} u_{x_i x_j} \nu_i \delta u_{x_j} + \sum_{i,j} (\Delta u_{x_j}) \nu_j \delta u \right) d\sigma \quad (10.4.35)$$

Consider different cases:

(a) Let us have both constrains (10.4.32) then we are done.

(b) Let us have only the first of constrains (10.4.32). Then on  $\Sigma'$  we have  $\delta u = 0$  and  $\nabla \delta u$  is parallel to  $\boldsymbol{\nu}$ :  $\nabla \delta u = \lambda \boldsymbol{\nu}$  with arbitrary function  $\phi$  (think why) and the second term in the parenthesis is 0 and the first term becomes  $-\sum_{i,j} u_{x_i x_j} \nu_i \nu_j \phi$  and we arrive to the missing condition

$$\sum_{i,j} u_{x_i x_j} \nu_i \nu_j |_{\Sigma'} = 0. \quad (10.4.36)$$

(c) Let us have no constraints on  $\Sigma'$ . Then we can recover this condition (10.4.36) but we need one more. Let us assume for simplicity that  $\Sigma'$  is flat; then without any loss of generality  $\Sigma'$  locally coincides with  $\{x_n = 0\}$ ,  $\boldsymbol{\nu} = (0, \dots, 0, 1)$  and condition (10.4.36) means that  $u_{x_n x_n} = 0$  on  $\Sigma'$ ; further, one can prove easily that then  $\delta\Phi = \iint_{\Sigma'} \frac{\partial \Delta u}{\partial \boldsymbol{\nu}} \delta u \, d\sigma$  with arbitrary  $\delta u$  and it implies the second condition

$$\left. \frac{\partial \Delta u}{\partial \boldsymbol{\nu}} \right|_{\Sigma'} = 0. \quad (10.4.37)$$

## 10.5 Variational methods in physics

### 10.5.1 Classical dynamics

In Theoretical Physics equations of movement are frequently derived as *Euler-Lagrange equations* for a functional called *action* and traditionally denoted by  $S$ .

In the *classical dynamics* important role is played by *Lagrange formalism*. Positions of the system are described by *generalized coordinates*  $\mathbf{q} = (q^1, q^2, \dots, q^N)$  which are functions of *time*  $t$ :  $\mathbf{q} = \mathbf{q}(t)$ . Then their derivatives  $\dot{\mathbf{q}} := \mathbf{q}_t$  are called *generalized velocities* (in physics upper dot traditionally is used for derivative with respect to  $t$ ).

*Lagrangian* then is a function of  $\mathbf{q}, \dot{\mathbf{q}}, t$ :  $L = L(\mathbf{q}, \dot{\mathbf{q}}, t)$  and usually  $L = T - U$  where  $T$  is a *kinetic energy* and  $U$  is a *potential energy* of the system.

Finally, *action*  $S$  is defined as

$$S = \int_{t_0}^{t_1} L(\mathbf{q}(t), \dot{\mathbf{q}}(t), t) \, dt \quad (10.5.1)$$

and we are looking for extremals of  $S$  as  $\mathbf{q}(t_0)$  (initial state) and  $\mathbf{q}(t_1)$  (final state) are fixed.

Then *Lagrange equations* are

$$\frac{\partial L}{\partial q_k} - \frac{d}{dt} \left( \frac{\partial L}{\partial \dot{q}_k} \right) = 0 \quad k = 1, \dots, N. \quad (10.5.2)$$

Next,  $\mathbf{p} = \frac{\partial L}{\partial \dot{\mathbf{q}}}$  that means

$$p_k = \frac{\partial L}{\partial \dot{q}_k} \quad k = 1, \dots, N \quad (10.5.3)$$

are *generalized momenta* and

$$H := \mathbf{p} \cdot \mathbf{q} - L = \sum_{k=1}^n \frac{\partial L}{\partial \dot{q}_k} \dot{q}_k - L \quad (10.5.4)$$

is considered as an *energy* and if expressed through  $\mathbf{q}, \mathbf{p}, t$  is called *Hamiltonian*  $H = H(\mathbf{q}, \mathbf{p}, t)$ .

Transition from generalized velocities to generalized momenta are called *Legendre transformation* and remarkable fact is that in  $(\mathbf{q}, \mathbf{p})$  movement equations are

$$\dot{q}_k = \frac{\partial H}{\partial p_k}, \quad (10.5.5)$$

$$\dot{p}_k = -\frac{\partial H}{\partial q_k}, \quad k = 1, \dots, N. \quad (10.5.6)$$

This is a *Hamiltonian formalism* and  $-\frac{\partial H}{\partial q_k}$  are called *generalized forces*. Another remarkable equality is

$$\frac{dH}{dt} = \frac{\partial H}{\partial t} \quad (10.5.7)$$

where in the left-hand expression  $(\mathbf{q}, \mathbf{p})$  are considered as functions of  $t$ .

We will not pursue this road, just mention that if we fix  $\mathbf{q}(t_0)$  and calculate action  $S$  defined by (10.5.1) along extremals we get  $S = S(\mathbf{q}, t)$ . Then it satisfies *Hamilton-Jacobi equation*

$$\frac{\partial S}{\partial t} + H(\mathbf{q}, \nabla S, t) = 0 \quad (10.5.8)$$

which is a *first order nonlinear PDE* mentioned in Subsection 2.2.2.

*Example 10.5.1.* Very often  $L = K - V$  where

$$K = \frac{1}{2} \sum_{j,k} g_{jk}(\mathbf{q}) \dot{q}_j \dot{q}_k \quad (10.5.9)$$

is a *kinetic energy* with positive defined symmetric matrix  $(g_{jk})$  and  $V = V(\mathbf{q})$  is a *potential energy*.

Then, Euler-Lagrange equations are

$$\frac{d}{dt} \sum g_{jk}(\mathbf{q}) \dot{q}_k = \sum_{lk} g_{lk, q_j}(\mathbf{q}) g_{jk}(\mathbf{q}) \dot{q}_j \dot{q}_k - V_{q_j}(\mathbf{q}). \quad (10.5.10)$$

Further

$$p_j = \sum g_{jk}(\mathbf{q}) \dot{q}_k \quad (10.5.11)$$

and

$$H(\mathbf{q}, \mathbf{p}) = \frac{1}{2} \sum g^{jk}(\mathbf{q}) p_j p_k + V(\mathbf{q}), \quad (10.5.12)$$

$(g^{jk}) = (g_{jk})^{-1}$  is also positive defined symmetric matrix.

In particular,

(a) in Cartesian coordinates for a point  $g_{jk} = m\delta_{jk}$  where  $m$  is the mass, so  $\mathbf{p} = m\dot{\mathbf{q}}$  is a usual momentum.

(b) On the other hand, for rotation of the solid about the center of the mass at 0,  $g_{jk} = I_{jk}$  is the **inertia tensor**, and  $\mathbf{p}$  is the angular momentum.

*Example 10.5.2.* Let now

$$L = K + \sum_j A_j(\mathbf{q}) \dot{q}_j - V(\mathbf{q}), \quad (10.5.13)$$

with the same  $K, V$  as in Example 10.5.1.

Then, Euler-Lagrange equations are

$$\frac{d}{dt} \sum g_{jk}(\mathbf{q}) \dot{q}_k = \sum_{lk} g_{lk, q_j}(\mathbf{q}) g_{jk}(\mathbf{q}) \dot{q}_j \dot{q}_k - V_{q_j}(\mathbf{q}) + \sum_k F_{jk}(\mathbf{q}) \dot{q}_k \quad (10.5.14)$$

with antisymmetric matrix

$$F_{jk} = A_{k, q_j} - A_{j, q_k}. \quad (10.5.15)$$

Here  $\mathbf{A} = (A_1, \dots, A_n)$  is a *vector-potential*,  $F_{jk}$  is a *tensor intensity of magnetic field*. The last term in (10.5.14) is a *Lorentz force*.

For  $n = 3$

$$F = \begin{pmatrix} 0 & F_z & -F_y \\ -F_z & 0 & F_x \\ F_y & -F_x & 0 \end{pmatrix}, \quad (10.5.16)$$

$\mathbf{F} = \nabla \times \mathbf{A}$  and the last term becomes familiar  $-\mathbf{F} \times \dot{\mathbf{q}}$ .

Further,

$$p_j = \sum g_{jk}(\mathbf{q})\dot{q}_k + A_j(\mathbf{q}) \quad (10.5.17)$$

and

$$H(\mathbf{q}, \mathbf{p}) = \frac{1}{2} \sum g^{jk}(\mathbf{q})(p_j - A_j(\mathbf{q}))(p_k - A_k(\mathbf{q})) + V(\mathbf{q}). \quad (10.5.18)$$

Note that  $\mathbf{A}(\mathbf{q}) \mapsto \mathbf{A}(\mathbf{q}) + \nabla\varphi(\mathbf{q})$  does not affect Euler-Lagrange equations,  $\mathbf{p} \mapsto \mathbf{p} - \nabla\varphi(\mathbf{q})$  and  $S \mapsto S + \varphi(\mathbf{q}^1) - \varphi(\mathbf{q}^0)$  where  $\mathbf{q}^0, \mathbf{q}^1$  are initial and final points of trajectory.

## 10.5.2 Continuum Dynamics

Now the state of the system is described by  $u(\mathbf{x}; t)$  where  $\mathbf{x} = (x_1, \dots, x_n)$  are *spatial variables* and the initial state  $u(\mathbf{x}; t_0)$  and the final state  $u(\mathbf{x}; t_1)$  are fixed and the action is defined by

$$S = \int_{t_0}^{t_1} \mathcal{L}(u, u_t, t) dt := \int_{t_0}^{t_1} \iiint L(u, u_x, \dots, u_t, \dots, t) d^n x dt \quad (10.5.19)$$

and *Lagrangian*  $L$  in fact depends on  $u, u_x = \nabla u$  and may be higher derivatives of  $u$  with respect to spatial variables, and on  $u_t$ .

Deriving Lagrange equations we treat  $t$  as just one of the coordinates (so we have  $\mathbf{x} = (x_0, x) = (x_0, x_1, \dots, x_n)$ , so we just borrow them from Sections 10.3 and 10.4 (with the trivial modification).

On the other hand, defining generalized momenta and forces and defining Hamiltonian  $t$  “sticks out”:

$$\pi = \frac{\delta \mathcal{L}}{\delta u_t}, \quad (10.5.20)$$

$$\varphi = -\frac{\delta \mathcal{L}}{\delta u}, \quad (10.5.21)$$

$$\mathcal{H} = \iiint \pi u_t dx - \mathcal{L}. \quad (10.5.22)$$

Then we can develop Hamiltonian mechanics:

$$\frac{\partial u}{\partial t} = \frac{\delta \mathcal{H}}{\delta \pi}, \quad (10.5.23)$$

$$\frac{\partial \pi}{\partial t} = -\frac{\delta \mathcal{H}}{\delta u}, \quad (10.5.24)$$

and

$$\frac{d}{dt}\mathcal{H} = \frac{\partial}{\partial t}\mathcal{H}; \quad (10.5.25)$$

so  $\mathcal{H}$  is constant provided it does not depend on  $t$  explicitly.

*Example 10.5.3.* Let

$$S = \frac{1}{2} \int_{t_0}^{t_1} \iiint (\rho u_t^2 - K|\nabla u|^2 + 2fu) d^n x dt; \quad (10.5.26)$$

Here  $f = f(\mathbf{x}, t)$  is a density of external force.

Then corresponding Lagrange equation is

$$-(\rho u_t)_t + \nabla \cdot (K\nabla u) - f = 0 \quad (10.5.27)$$

which for constant  $\rho, K$  becomes a standard *wave equation*. Meanwhile as

$$\mathcal{L} = \frac{1}{2} \iiint (\rho u_t^2 - K|\nabla u|^2 + 2fu) d^n x \quad (10.5.28)$$

we have according to (10.5.20)–(10.5.22)

$$\begin{aligned} \pi(x) &= \rho u_t, \\ \varphi(x) &= \nabla \cdot (K\nabla u) + f, \\ \mathcal{H} &= \frac{1}{2} \iiint (\rho u_t^2 + K|\nabla u|^2 - 2fu) d^n x \end{aligned} \quad (10.5.29)$$

and  $\mathcal{H}$  is preserved as long as  $\rho, K, f$  do not depend on  $t$ .

*Example 10.5.4.* Similarly,

$$S = \frac{1}{2} \int_{t_0}^{t_1} \iiint (\rho |\mathbf{u}_t|^2 - \lambda |\nabla \otimes \mathbf{u}|^2 - \mu |\nabla \cdot \mathbf{u}|^2 + 2\mathbf{f} \cdot \mathbf{u}) d^n x dt \quad (10.5.30)$$

with constant  $\rho, \lambda, \mu$  leads to *elasticity equations*

$$-\rho \mathbf{u}_{tt} + \lambda \Delta \mathbf{u} + \mu \nabla (\nabla \cdot \mathbf{u}) + \mathbf{f} = 0 \quad (10.5.31)$$

and

$$\mathcal{H} = \frac{1}{2} \iiint (\rho |\mathbf{u}_t|^2 + \lambda |\nabla \otimes \mathbf{u}|^2 + \mu |\nabla \cdot \mathbf{u}|^2 - 2\mathbf{f} \cdot \mathbf{u}) d^n x. \quad (10.5.32)$$

We use notations  $\nabla \otimes \mathbf{u} = (\partial_j u_k)$  is the matrix of derivatives and  $|\nabla \otimes \mathbf{u}|^2 = (\sum_{j,k} (\partial_j u_k)^2)^{1/2}$ .

*Example 10.5.5.* Let  $n = 3$ , then  $|\nabla \otimes \mathbf{u}|^2 = |\nabla \times \mathbf{u}|^2 + |\nabla \cdot \mathbf{u}|^2$ . Taking in Example 10.5.4  $\rho = 1$ ,  $\mu = -\lambda = -c^2$  and  $\mathbf{f} = 0$  we have

$$S = \frac{1}{2} \int_{t_0}^{t_1} \iiint \left( |\mathbf{u}_t|^2 - c^2 |\nabla \times \mathbf{u}|^2 \right) d^3x dt, \quad (10.5.33)$$

$$-\mathbf{u}_{tt} - c^2 \nabla \times (\nabla \times \mathbf{u}) = 0 \quad (10.5.34)$$

which is Maxwell equations without charges and currents for a *vector potential*  $\mathbf{u}$ , taking  $\mathbf{E} = \mathbf{u}_t$ ,  $\mathbf{H} = \nabla \times \mathbf{u}$  we arrive to Maxwell equations in more standard form Section 14.3.

*Example 10.5.6.* Let

$$S = \frac{1}{2} \int_{t_0}^{t_1} \iiint \left( u_t^2 - \sum_{i,j} K u_{x_i x_j}^2 + 2fu \right) d^n x dt. \quad (10.5.35)$$

Then we arrive to

$$-u_{tt} - K \Delta^2 u + f = 0 \quad (10.5.36)$$

which is *vibrating beam equation* as  $n = 1$  and *vibrating plate equation* as  $n = 2$ ; further

$$\mathcal{H} = \frac{1}{2} \iiint \left( \rho u_t^2 + \sum_{i,j} K u_{x_i x_j}^2 - 2fu \right) d^n x. \quad (10.5.37)$$

*Example 10.5.7.* Let  $\psi(\mathbf{x}, t)$  be complex-valued function,  $\bar{\psi}(\mathbf{x}, t)$  its complex-conjugate and

$$S = \int_{t_0}^{t_1} \iiint \left( i\hbar(\psi \bar{\psi}_t - \bar{\psi} \psi_t) - 2 \left( \frac{\hbar^2}{2m} |\nabla \psi|^2 + V(\mathbf{x}) |\psi|^2 \right) \right) d^n x dt. \quad (10.5.38)$$

Then Lagrange equation is  $-i\hbar \bar{\psi}_t + \left( \frac{\hbar^2}{2m} \Delta - V(\mathbf{x}) \right) \bar{\psi} = 0$  which is equivalent to the standard Schrödinger equation

$$i\hbar \psi_t = \left( -\frac{\hbar^2}{2m} \Delta + V(\mathbf{x}) \right) \psi. \quad (10.5.39)$$

*Example 10.5.8.* Further  $\pi(\mathbf{x}, t) = -i\hbar \bar{\psi}(\mathbf{x}, t)$  and

$$\begin{aligned} \mathcal{H} = \iiint \left( \frac{\hbar^2}{2m} |\nabla \psi|^2 + V(\mathbf{x}) |\psi|^2 \right) d^n x = \\ \iiint \left( -\frac{\hbar^2}{2m} \Delta + V(\mathbf{x}) \right) \psi \cdot \bar{\psi} d^n x. \end{aligned} \quad (10.5.40)$$

*Hint.* Write  $\psi = \psi_1 + i\psi_2$  where  $\psi_1 = \text{Re}(\psi)$ ,  $\psi_2 = \text{Im}(\psi)$  and use

$$\frac{\delta}{\delta\psi} = \frac{1}{2} \left( \frac{\delta}{\delta\psi_1} - i \frac{\delta}{\delta\psi_2} \right), \quad (10.5.41)$$

which corresponds conventions of Complex Variables. Integrate by parts with respect to  $t$  to have only  $\delta\psi$ , but not  $\delta\psi_t$ .

*Exercise 10.5.1.* Write in the same way Lagrangian and Hamiltonian for the following equations:

$$-i\hbar\psi_t = H\psi, \quad (10.5.42)$$

where  $H$  is

- (a) Schrödinger operator with magnetic field (14.3.3).
- (b) Schrödinger-Pauli operator with magnetic field (14.3.4).
- (c) Dirac operator with magnetic field (14.3.14).

### 10.5.3 Equilibria

Selecting  $u = u(\mathbf{x})$  in the dynamical equations (and then  $u_t = 0$ ) we get equations of equilibria. Equilibria which delivers to potential energy  $U$  local minimum is stable; otherwise it is unstable.

*Exercise 10.5.2.* In Example 10.5.3, Example 10.5.4 and Example 10.5.6 write equations of equilibria.

### Appendix 10.5.A. Nonholonomic mechanic

Not all mechanics (leave alone physics) obeys variational principles. Consider system with Lagrangian  $L = L(\mathbf{q}, \dot{\mathbf{q}}, t)$ . If there are no constraints, corresponding variational problem is for a functional

$$S = \int_{t_0}^{t_1} L(\mathbf{q}, \dot{\mathbf{q}}, t) dt. \quad (10.1)$$

and the Euler-Lagrange equations describe system correctly:

$$-\frac{d}{dt}L_{\dot{\mathbf{q}}} + L_{\mathbf{q}} = 0. \quad (10.2)$$



If there are constrains

$$f_1(\mathbf{q}, t) = f_2(\mathbf{q}, t) = \dots = f_m(\mathbf{q}, t) = 0, \quad (10..3)$$

then one needs to consider a corresponding variational problem is for a functional

$$S = \int_{t_0}^{t_1} L^*(\mathbf{q}, \dot{\mathbf{q}}, t) dt. \quad (10..4)$$

with

$$L^*(\mathbf{q}, \dot{\mathbf{q}}, t) = L(\mathbf{q}, \dot{\mathbf{q}}, t) - \lambda_1(t)f_1(\mathbf{q}, t) - \dots - \lambda_m(t)f_m(\mathbf{q}, t), \quad (10..5)$$

and the Euler-Lagrange equations (together with constrains) describe system correctly:

$$-\frac{d}{dt}L_{\dot{\mathbf{q}}} + L_{\mathbf{q}} = \sum_j \lambda_j(t)f_{j,\mathbf{q}}. \quad (10..6)$$

Here  $\lambda_j(t)$  are unknown functions.

However sometimes (in the problems with rolling) constrains are

$$\mathbf{a}_1(\mathbf{q}, t) \cdot \dot{\mathbf{q}} = \dots = \mathbf{a}_m(\mathbf{q}, t) \cdot \dot{\mathbf{q}} = 0, \quad (10..7)$$

and this system cannot be integrated.

Then variational principles lead to

$$L^*(\mathbf{q}, \dot{\mathbf{q}}, t) = L(\mathbf{q}, \dot{\mathbf{q}}, t) - \lambda_1(t)\mathbf{a}_1(\mathbf{q}, t) \cdot \dot{\mathbf{q}} - \dots - \lambda_m(t)\mathbf{a}_m(\mathbf{q}, t) \cdot \dot{\mathbf{q}}. \quad (10..8)$$

However, Euler-Lagrange equations for it (together with constrains) are not describing this system properly. Correct equations are

$$-\frac{d}{dt}L_{\dot{\mathbf{q}}} + L_{\mathbf{q}} = \sum_j \mu_j(t)\mathbf{a}_j \quad (10..9)$$

with unknown functions  $\mu_j(t)$ .

One can write corresponding Euler-Lagrange equations and compare!

This leads to *nonholonomic mechanics*.

## Problems to Chapter 10

There are several classical problems

*Problem 1.* The heavy flexible but unstretchable wire (chain) has a length and an energy respectively

$$L = \int_0^a \sqrt{1 + u'^2} dx, \quad (1)$$

$$U = \rho g \int_0^a u \sqrt{1 + u'^2} dx \quad (2)$$

where  $\rho$  is a linear density.

- (a) Write down an equation minimizing energy  $U$  as length  $L$  is fixed.
- (b) Find solution satisfying  $u(0) = h_0$ ,  $u(a) = h_1$ .

*Problem 2.* We need to construct the fastest slide from point  $(0, 0)$  to  $(a, -h)$ . If  $u(x)$  describes its shape then time is

$$T = \int_0^a \frac{1}{\sqrt{2gu}} \sqrt{1 + u'^2} dx. \quad (3)$$

- (a) Write down an equation minimizing energy  $U$  as length  $L$  is fixed.
- (b) Find solution satisfying  $u(0) = 0$ ,  $u(a) = -h$ .

*Problem 3.* If in 2D-light propagation the speed of light at point  $(x, y)$  is  $c(x, y)$  then the time of travel between two points  $(x_1, y_1)$  and  $(x_2, y_2)$  equals

$$T = \int_{x_1}^{x_2} \frac{\sqrt{1 + u'^2} dx}{c(x, u(x))} \quad (4)$$

where  $y = u(x)$  is equation of the ray,  $u(x_j) = y_j$ ,  $j = 1, 2$ .

- (a) Write down Euler' equation.
- (b) Consider the case of  $c(x, y)$  depending only on  $y$  and reduce the 1-order equation to 1-st order one using conservation law  $H(u, u') = \text{const}$  where  $H = u' L_{u'} - L$  is a corresponding Hamiltonian,  $L$  is a Lagrangian.

*Problem 4.* The area of the surface is

$$S = \iint_D \sqrt{1 + u_x^2 + u_y^2} \, dx dy \quad (5)$$

where  $z = u(x, y)$ ,  $(x, y) \in D$  is an equation of the surface.

(a) Write Euler-Lagrange PDE of the surface of the minimal area (with boundary conditions  $u(x, y) = \phi(x, y)$  as  $(x, y) \in \Gamma$  which is the boundary of  $D$ ).

(b) if the potential energy is

$$E = kS - \iint_D f u \, dx dy \quad (6)$$

with  $S$  defined by (5) and  $f$  areal density of external force.

Write Euler-Lagrange PDE of the surface of the minimal energy.

*Problem 5.* If the surface is a surface of revolution  $z = u(r)$  with  $r^2 = x^2 + y^2$  then

$$S = 2\pi \int_D \sqrt{1 + u_r^2} r \, dr \quad (7)$$

Write Euler-Lagrange equation and solve it.

*Problem 6.* Write equation and boundary conditions for stationary points of the functional

$$\Phi(u) = \iint_D \left( u_x^2 + u_x u_y + u_y^2 - 2uf(x, y) \right) dx dy$$

with  $D = \{(x, y) : 0 < x < 2, 0 < y < 1\}$ , satisfying boundary conditions

$$u|_{x=0} = u|_{x=2} = 0.$$

*Problem 7.* Write equation and boundary conditions for stationary points of the functional

$$\Phi(u) = \iint_D \left( u_x^2 - u_x u_y + u_y^2 \right) dx dy + \int_{\Gamma} 2ug(y) dy$$

with  $D = \{(x, y) : 0 < x < 2, 0 < y < 1\}$ ,  $\Gamma = \{(x, y) : x = 0, 0 < y < 1\}$ , satisfying boundary conditions

$$u|_{y=0} = u|_{y=1} = u|_{x=2} = 0.$$

*Problem 8.* Write equation and boundary conditions for stationary points of the functional

$$\Phi(u) = \iint_D \left( u_x^2 - 2u_x u_y + 2u_y^2 \right) dx dy + \int_{\Gamma} \left( u^2 + 2ug(x) \right) dx$$

with  $D = \{(x, y) : 0 < x < 2, 0 < y < 1\}$ ,  $\Gamma = \{(x, y) : y = 1, 0 < x < 2\}$ .

*Problem 9.* Write equation and boundary conditions for stationary points of the functional

$$\Phi(u) = \iint_D \left( 2u_x^2 - 3u_x u_y + 2u_y^2 + u^2 - 2f(x, y)u \right) dx dy$$

with  $D = \{(x, y) : 0 < x < 2, 0 < y < 1\}$ , satisfying boundary conditions

$$u|_{y=0} = u|_{y=1} = u|_{x=2} = 0.$$

*Problem 10.* Write equation and boundary conditions for stationary points of the functional

$$\Phi(u) = \iint_D \left( u_x^2 - u_x u_y + u_y^2 - 2f(x, y)u \right) dx dy$$

with  $D = \{(x, y) : 0 < x < 2, 0 < y < 1\}$ , satisfying boundary conditions

$$u|_{y=0, 1 < x < 2} = u|_{x=0} = u|_{x=2} = 0.$$

*Problem 11.* Write equation and boundary conditions for stationary points of the functional

$$\Phi(u) = \iint_D \left( u_x^2 + 2u_x u_y + 3u_y^2 \right) dx dy + 2 \int_{\Gamma} g(x)u dx$$

with  $D = \{(x, y) : 0 < x < 2, 0 < y < 1\}$ ,  $\Gamma = \{(x, y) : y = 1\}$ , satisfying boundary conditions

$$u|_{y=0} = u|_{x=0} = u|_{x=2} = u|_{y=1, 0 < x < 1} = 0.$$

*Problem 12.* Write equation and boundary conditions for stationary points of the functional

$$\Phi(u) = \iint_D (u_x^2 - u_x u_y + 3u_y^2) dx dy + \int_{\Gamma} u^2 dx$$

with  $D = \{(x, y) : 0 < x < 2, 0 < y < 1\}$ ,  $\Gamma = \{(x, y) : y = 0, 0 < x < 1\}$  satisfying boundary conditions

$$u|_{y=1} = u|_{x=0} = 0, \quad u|_{x=2} = g(y).$$

*Problem 13.* Write equation and boundary conditions for stationary points of the functional

$$\Phi(u) = \iint_D (u_x^2 - 2u_x u_y + 2u_y^2) dx dy + \int_{\Gamma} (u^2 + 2g(x)u) dx$$

with  $D = \{(x, y) : 0 < x < 2, 0 < y < 1\}$ ,  $\Gamma = \{(x, y) : y = 0, 0 < x < 1\}$  satisfying boundary conditions

$$u|_{y=1} = u|_{x=0} = u|_{x=2} = u|_{y=0, 1 < x < 2} = 0.$$

*Problem 14.* Write equation and boundary conditions for stationary points of the functional

$$\Phi(u) = \int_0^1 \left( (u'')^2 - 2(u')^2 + 2f(x)u \right) dx + 4u(0)^2$$

satisfying boundary conditions

$$u'(1) = u(1).$$

*Problem 15.* Write equation and boundary conditions for stationary points of the functional

$$\Phi(u) = \int_0^1 \left( (u'')^2 + u^2 + 2f(x)u \right) dx - (u'(0))^2$$

satisfying boundary conditions

$$u(0) = u(1).$$

*Problem 16.* Write equation and boundary conditions for stationary points of the functional

$$\Phi(u) = \int_0^1 \left( (u'')^2 + (u')^2 + 2f(x)u \right) dx - u(1)^2$$

satisfying boundary conditions

$$u(0) = u(1), \quad u'(0) = u'(1).$$

*Problem 17.* Write equation and boundary conditions for stationary points of the functional

$$\Phi(u) = \int_0^1 \left( (u'')^2 - 2(u')^2 + u^2 \right) dx + 2u(1)$$

satisfying boundary conditions

$$u(0) = -u(1), \quad u'(0) = u'(1).$$

# Chapter 11

## Distributions and weak solutions

In this Chapter we extend notion of function. These new “functions” (actually most of them are not functions at all) are called *distributions* and are very useful for PDE (and not only). We define them as linear forms on the *test functions* which are some nice functions. For usual function  $f$  such form is

$$f(\varphi) = \int f(x)\varphi(x), dx.$$

We also extend the notion of solution.

### 11.1 Distributions

#### 11.1.1 Test functions

We introduce three main spaces of test functions:

**Definition 11.1.1.** Let

- (a)  $\mathcal{D} = C_0^\infty$  is a space of infinitely smooth functions with compact support. It means that for each function  $\varphi$  exists  $a$  such that  $\varphi(x) = 0$  as  $|x| \geq a$ ;
- (b)  $\mathcal{E} = C^\infty$  is a space of infinitely smooth functions;

- (c)  $\mathcal{S}$  is a space of infinitely smooth functions which decay at infinity (with all their derivatives) faster than any power:

$$|\partial^m \varphi|(1 + |x|)^k \leq M_{mk} \quad \forall x \forall m, k. \quad (11.1.1)$$

Loran Schwartz who provided the first systematic theory of distributions used these notations and they became traditional. However we need to explain what does it mean *convergence of test function*:

**Definition 11.1.2.** (a)  $\varphi_n \rightarrow \varphi$  in  $\mathcal{D}$  iff  $\max_x |\partial^m(\varphi_n - \varphi)| \rightarrow 0$  as  $n \rightarrow \infty$  for all  $m$  and also there exist  $a$  such that  $\varphi_n(x) = 0$  as  $|x| \geq a$  for all  $n$ ;

(b)  $\varphi_n \rightarrow \varphi$  in  $\mathcal{E}$  iff  $\max_{|x| \leq a} |\partial^m(\varphi_n - \varphi)| \rightarrow 0$  as  $n \rightarrow \infty$  for all  $m, a$ ;

(c)  $\varphi_n \rightarrow \varphi$  in  $\mathcal{S}$  iff

$$|\partial^m(\varphi_n - \varphi)|(1 + |x|)^k \rightarrow 0 \quad \forall x \forall m, k. \quad (11.1.2)$$

**Theorem 11.1.1.**

$$\mathcal{D} \subset \mathcal{S} \subset \mathcal{E} \quad (11.1.3)$$

where  $\mathcal{K}_1 \subset \mathcal{K}_2$  means not only that all elements of  $\mathcal{K}_1$  are also elements of  $\mathcal{K}_2$  but also that  $\varphi_n \xrightarrow{\mathcal{K}_1} \varphi$  implies that  $\varphi_n \xrightarrow{\mathcal{K}_2} \varphi$ . Also in (11.1.3) each smaller space  $\mathcal{K}_1$  is dense in the larger one  $\mathcal{K}_2$ : for each  $\varphi \in \mathcal{K}_2$  there exists a sequence  $\varphi_n \in \mathcal{K}_1$  converging to  $\varphi$  in  $\mathcal{K}_2$ .

*Remark 11.1.1.* Those who studies Real Analysis heard about *Topological Vector Spaces* but we are not going to introduce topology (which is ridiculously complicated on  $\mathcal{D}$ ), just convergence is sufficient for all needs. The same approach is also used in the very advanced courses.

## 11.1.2 Distributions

**Definition 11.1.3.** (a) *Distribution*  $f$  (over  $\mathcal{K}$ ) is a continuous linear form on  $\mathcal{K}$ :  $f : \mathcal{K} \rightarrow \mathbb{C}$  such that

$$\begin{aligned} f(\alpha_1 \varphi_1 + \alpha_2 \varphi_2) &= \alpha_1 f(\varphi_1) + \alpha_2 f(\varphi_2) \quad \forall \varphi_1, \varphi_2 \in \mathcal{K} \quad \forall \alpha_1, \alpha_2 \in \mathbb{C}; \\ \varphi_n \xrightarrow{\mathcal{K}} \varphi &\implies f(\varphi_n) \rightarrow f(\varphi). \end{aligned}$$

- (b) The space of such linear forms is denoted by  $\mathcal{K}'$ .



Theorem 11.1.1 immediately implies

**Theorem 11.1.2.**

$$\mathcal{D}' \supset \mathcal{S}' \supset \mathcal{E}' \quad (11.1.4)$$

where  $\mathcal{K}'_1 \supset \mathcal{K}'_2$  means not only that all elements of  $\mathcal{K}'_2$  are also elements of  $\mathcal{K}'_1$  but also that  $f_n \xrightarrow{\mathcal{K}'_2} f$  implies that  $f_n \xrightarrow{\mathcal{K}'_1} f$ . Also in (11.1.4) each smaller space  $\mathcal{K}'_2$  is dense in the larger one  $\mathcal{K}'_1$ : for each  $f \in \mathcal{K}'_1$  there exists a sequence  $f_n \in \mathcal{K}'_2$  converging to  $f$  in  $\mathcal{K}'_1$ .

So far we have not introduced the convergence of distributions, so we do it right now:

**Definition 11.1.4.**  $f_n \xrightarrow{\mathcal{K}'} f$  iff  $f_n(\varphi) \rightarrow f(\varphi)$  for all  $\varphi \in \mathcal{K}$ .

*Remark 11.1.2.* (a)  $\mathcal{E}'$  consists of distributions with compact support:  $f \in \mathcal{D}'$  belongs to  $\mathcal{E}'$  iff there exists  $a$  such that  $f(\varphi) = 0$  for all  $\varphi$  such that  $\varphi(x) = 0$  as  $|x| \leq a$ .

(b)  $\mathcal{S}'$  consists of *temperate distributions*.

(c) For  $f \in L^1_{\text{loc}}$  we can define action  $f(\varphi)$  on  $\mathcal{D}$

$$f(\varphi) = \int f(x)\varphi(x) dx \quad (11.1.5)$$

where integral is always understood as integral over the whole line  $\mathbb{R}$  (or a whole space  $\mathbb{R}^d$ ) and  $L^1_{\text{loc}}$  consists of *locally integrable functions* (notion from the Real Analysis which means that  $\int_{|x| \leq a} |f(x)| dx < \infty$  for all  $a$  but integral is a *Lebesgue integral* which is a natural extension of Riemann integral). One can prove that this form is continuous and thus  $f \in \mathcal{D}'$ . Due to this we sometimes non-rigorously will write (11.1.5) even for distributions which are not ordinary functions.

*Example 11.1.1.*  $\delta := \delta(x)$  is an element of  $\mathcal{E}'$  defined as  $\delta(\varphi) = \varphi(0)$ . It is traditionally called  $\delta$ -function or *Dirac  $\delta$ -function* despite not being a function but a distribution.

### 11.1.3 Operations on distributions

We introduce operations on distributions as an extension of operations on ordinary functions as long as they make sense.

**Definition 11.1.5.** *Linear operations:*

$$(\alpha_1 f_1 + \alpha_2 f_2)(\varphi) = \alpha_1 f_1(\varphi) + \alpha_2 f_2(\varphi) \quad (11.1.6)$$

as  $\alpha_1, \alpha_2 \in \mathbb{C}$ .

*Exercise 11.1.1.* Check that for ordinary functions  $f_1, f_2$  we get a standard definition of  $\alpha_1 f_1 + \alpha_2 f_2$  (in the framework of (11.1.5)).

**Definition 11.1.6.** *Shift.* Let  $T_a$  denote a shift of  $\varphi$ :  $(T_a \varphi)(x) = \varphi(x - a)$ . Then

$$(T_a f)(\varphi) = f(T_{-a} \varphi). \quad (11.1.7)$$

We will write  $T_a f$  as  $f(x - a)$ .

*Exercise 11.1.2.* (a) Check that for ordinary function  $f$  we get a standard definition of  $f(x - a)$  (in the framework of (11.1.5)).

(b) Check that for  $\delta$  we  $\delta_a(x) := \delta(x - a)$  is defined as  $\delta_a(\varphi) = \varphi(a)$ .

**Definition 11.1.7.** *Linear change of variables.* Let  $R_A$  denote a linear change of variables:  $(R_A \varphi)(x) = \varphi(Ax)$  where  $A$  is a non-degenerate linear transformation. Then

$$(R_A f)(\varphi) = |\det A|^{-1} f(R_{A^{-1}} \varphi) \quad (11.1.8)$$

We will write  $R_A f$  as  $f(Ax)$ .

*Exercise 11.1.3.* (a) Check that for ordinary function  $f$  we get a standard definition of  $R_A f$  (in the framework of (11.1.5)).

(b) Check that for  $\delta$  we get  $\delta(Ax) = |\det A|^{-1} \delta(x)$ . In particular, as  $|\det A| = 1$  we have  $\delta(Ax) = \delta(x)$  and as  $Ax = \lambda x$  (uniform dilatation)  $\delta(\lambda x) = |\lambda|^{-d} \delta(x)$  where  $d$  is a dimension. Therefore  $\delta$  is *spherically symmetric* and *positively homogeneous of degree  $-d$* .

**Definition 11.1.8.** *Derivative.* Then

$$(\partial f)(\varphi) = -f(\partial\varphi) \quad (11.1.9)$$

where  $\partial$  is a first order derivative.

*Exercise 11.1.4.* (a) Check that for ordinary function  $f$  we get a standard definition of  $\partial f$  (in the framework of (11.1.5)). Use integration by parts.

(b) Check that for  $\delta$  we get  $\delta'_a(\varphi) = -\varphi'(a)$  (in one dimension and similarly in higher dimensions).

(c) Check that if  $\theta(x)$  is a *Heaviside function*:  $\theta(x) = 1$  as  $x > 0$  and  $\theta(x) = 0$  as  $x \leq 0$  then  $\theta'(x) = \delta(x)$ .

(d) Check that if  $f(x)$  is a smooth function as  $x < a$  and as  $x > 0$  but with a jump at  $a$  then  $f' = \overset{\circ}{f}' + (f(a+0) - f(a-0))\delta(x-a)$  where  $f'$  is understood in the sense of distributions and  $\overset{\circ}{f}'(x)$  is an ordinary function equal to derivative of  $f$  as  $x \neq a$ .

(e) Prove that if  $f = \ln|x|$  then

$$f'(\varphi) = pv \int x \{-1\} \varphi(x), dx := \lim_{\varepsilon \rightarrow +0} \int_{|x| > \varepsilon} x^{-1} \varphi(x) dx,$$

where integral is understood as a principal value integral.

Let  $g \in C^\infty$ . Observe that for  $g\varphi \in \mathcal{D}$  and  $g\varphi \in \mathcal{E}$  for  $\varphi \in \mathcal{D}$  and  $\varphi \in \mathcal{E}$  respectively. Therefore the following definition makes sense:

**Definition 11.1.9.** *Multiplication by a function.* Let either  $f \in \mathcal{D}'$  or  $f \in \mathcal{E}'$ . Then  $gf \in \mathcal{D}'$  or  $gf \in \mathcal{E}'$  respectively is defined as

$$(gf)(\varphi) = f(g\varphi). \quad (11.1.10)$$

*Exercise 11.1.5.* (a) Check that for ordinary function  $f$  we get a standard definition of  $gf$  (in the framework of (11.1.5)).

(b) Prove that  $g\delta_a = g(a)\delta_a$  (use definitions);

(c) Calculate  $g\delta'_a, g\delta''_a$  (use definitions!).

We cannot define in general the product of two distributions. However in some cases it is possible, f.e. when distributions are of different arguments.

**Definition 11.1.10.** *Direct product.* Let  $f, g$  be distributions. Then  $f(x)g(y)$  (also denoted as  $f \otimes g$ ) is defined as

$$(fg)(\varphi) = f(g(\varphi)) \quad (11.1.11)$$

where  $\varphi = \varphi(x, y)$ , then applying  $g$  to it we get  $\psi(x) := g(\varphi)$  a test function, and then applying  $f$  we get a number. Similarly we get the same  $fg$  if we apply first  $f$  and then  $g$ .

*Exercise 11.1.6.* (a) Check that for ordinary functions  $f, g$  we get a standard definition of  $fg$  (in the framework of (11.1.5)).

(b) Prove that  $\delta_{a_1}(x_1) \cdots \delta_{a_d}(x_d) = \delta_a(x)$  with  $a = (a_1, \dots, a_d)$ ,  $x = (x_1, \dots, x_d)$  and we have on the left product of 1-dimensional  $\delta$ -functions and on the right  $n$ -dimensional.

## 11.2 Distributions: more

### 11.2.1 Supports

**Definition 11.2.1.** Let us consider ordinary function  $f$ . Observe that if  $f = 0$  on open sets  $\Omega_i$  (where  $i$  runs any set of indices—finite, infinite or even non-enumerable) then  $f = 0$  on  $\bigcup_i \Omega_i$ . Therefore there exists a largest open set  $\Omega$  such that  $f = 0$  on  $\Omega$ . Complement to this set is called *support of  $f$*  and denoted as  $\text{supp}(f)$ .

**Definition 11.2.2.** (a) Let us consider distribution  $f$ . We say that  $f = 0$  on open set  $\Omega$  if  $f(\varphi) = 0$  for any test function  $\varphi$  such that  $\text{supp } \varphi \subset \Omega$ .

(b) Then the same observation as in (a) holds and therefore there exists a largest open set  $\Omega$  such that  $f = 0$  on  $\Omega$ . Complement to this set is called *support of  $f$*  and denoted as  $\text{supp}(f)$ .

**Definition 11.2.3.** Observe that  $\text{supp}(f)$  is always a closed set. If it is also bounded we say that  $f$  has a compact support.

*Exercise 11.2.1.* (a) Prove that for two functions  $f, g$  and for  $f \in \mathcal{D}'$ ,  $g \in \mathcal{E}$

$$\text{supp}(gf) \subset \text{supp}(f) \cap \text{supp}(g), \quad (11.2.1)$$

$$\text{supp}(\partial f) \subset \text{supp}(f) \quad (11.2.2)$$

where  $\partial$  is a differentiation;

(b) Prove that  $\text{supp}(f) = \emptyset$  iff  $f = 0$  identically;

(c) Prove that  $\text{supp}(\delta_a) = \{a\}$ . Prove that the same is true for any of its derivatives.

*Remark 11.2.1.* In fact, the converse to Exercise 1(c) is also true: if  $\text{supp}(f) = \{a\}$  then  $f$  is a linear combination of  $\delta(x - a)$  and its derivatives (up to some order).

*Remark 11.2.2.* In the previous section we introduced spaces of test functions  $\mathcal{D}$  and  $\mathcal{E}$  and the corresponding spaces of distributions  $\mathcal{D}'$  and  $\mathcal{E}'$ . However for domain  $\Omega \subset \mathbb{R}^d$  one can introduce  $\mathcal{D}(\Omega) := \{\varphi \in \mathcal{D} : \text{supp } \varphi \subset \Omega\}$  and  $\mathcal{E} = C^\infty(\Omega)$ . Therefore one can introduce corresponding spaces of distributions  $\mathcal{D}'(\Omega)$  and  $\mathcal{E}'(\Omega) = \{f \in \mathcal{E}' : \text{supp } f \subset \Omega\}$ . As  $\Omega = \mathbb{R}^d$  we get our “old spaces”.

## 11.2.2 Non-linear change of variables

**Definition 11.2.4.** Let  $f$  be a distribution with  $\text{supp } f \subset \Omega_1$  and let  $\Phi : \Omega_1 \rightarrow \Omega_2$  be one-to-one correspondence, infinitely smooth and with non-vanishing Jacobian  $\det \Phi'$ . Then  $\Phi_* f$  is a distribution:

$$(\Phi_* f)(\varphi) = f(|\det \Phi'| \cdot \Phi^* \varphi) \quad (11.2.3)$$

where  $(\Phi^* \varphi)(x) = \varphi(\Phi(x))$ .

*Remark 11.2.3.* (a) This definition generalizes Definitions 11.1.6 and 11.1.7.

(b) Mathematicians call  $\Phi^* \varphi$  *pullback of  $\varphi$*  and  $\Phi_* f$  *pushforward of  $f$* .

*Exercise 11.2.2.* Check that for ordinary function  $f$  we get  $(\Phi_* f)(x) = f(\Phi^{-1}(x))$ .

### 11.2.3 Fourier transform

**Definition 11.2.5.** Let  $f \in \mathcal{S}'$ . Then Fourier transform  $\hat{f} \in \mathcal{S}'$  is defined as

$$\hat{f}(\varphi) = f(\hat{\varphi}) \quad (11.2.4)$$

for  $\varphi \in \mathcal{S}$ . Similarly, inverse Fourier transform  $\check{f} \in \mathcal{S}'$  is defined as

$$\check{f}(\varphi) = f(\check{\varphi}) \quad (11.2.5)$$

*Exercise 11.2.3.* (a) Check that for ordinary function  $f$  we get a standard definition of  $\hat{f}$  and  $\check{f}$ .

(b) To justify Definition 5 one need to prove that  $f \in \mathcal{S} \iff \hat{f} \in \mathcal{S}$ . Do it!

(c) Prove that for  $f \in \mathcal{E}'$  both  $\hat{f}$  and  $\check{f}$  are ordinary smooth functions

$$\hat{f}(k) = (2\pi)^{-d} f(e^{-ix \cdot k}), \quad (11.2.6)$$

$$\check{f}(k) = f(e^{ix \cdot k}). \quad (11.2.7)$$

(d) Check that all properties of Fourier transform (excluding with norms and inner products which may not exist are preserved).

*Exercise 11.2.4.* (a) Prove that Fourier transforms of  $\delta(x-a)$  is  $(2\pi)^{-d} e^{-ix \cdot a}$ .

(b) Prove that Fourier transforms of  $e^{ix \cdot a}$  is  $\delta(x-a)$ .

*Exercise 11.2.5.* In dimension 1

(a) Prove that Fourier transforms of  $\theta(x-a)$  and  $\theta(-x+a)$  are respectively  $(2\pi i)^{-1}(k-a-i0)^{-1}$  and  $-(2\pi i)^{-1}(k-a+i0)^{-1}$  which are understood as limits in the sense of distributions of  $(2\pi i)^{-1}(k-a \mp i\varepsilon)^{-1}$  as  $\varepsilon \rightarrow +0$ . Recall that  $\theta(x)$  is a Heaviside function.

(b) As a corollary conclude that Fourier transform of

$$\text{sign}(x) := \theta(x) - \theta(-x) = \frac{x}{|x|}$$

equals

$$(2\pi i)^{-1}((k-a-i0)^{-1} + (k-a+i0)^{-1})^{-1} = \pi^{-1}(k-a)^{-1}$$

with the latter understood in as principal value (see 11.1.4(f)).

(c) As another corollary conclude that Fourier transform of  $\theta(x) + \theta(-x) = 1$  is  $(2\pi i)^{-1}((k - a - i0)^{-1} - (k - a + i0)^{-1})$  and therefore

$$(2\pi i)^{-1}((k - a - i0)^{-1} - (k - a + i0)^{-1}) = \delta(x - a). \quad (11.2.8)$$

### 11.2.4 Convolution

Recall convolution (see Definition 5.2.1) and its connection to Fourier transform.

**Definition 11.2.6.** Let  $f, g \in \mathcal{D}'$  (or other way around),  $\varphi \in \mathcal{D}$ . Then we can introduce  $h(y) \in \mathcal{E}$  as

$$h(y) = g(T_y \varphi), \quad T_y \varphi(x) := \varphi(x - y).$$

Observe that  $h \in \mathcal{D}$  provided  $g \in \mathcal{E}'$ . In this case we can introduce  $h \in \mathcal{E}$  for  $\varphi \in \mathcal{E}$ .

Therefore if either  $f \in \mathcal{E}'$  or  $g \in \mathcal{E}'$  we introduce  $f * g$  as

$$(f * g)(\varphi) = f(h).$$

*Exercise 11.2.6.* (a) Check that for ordinary function  $f$  we get a standard definition of the convolution;

(b) Prove that convolution convolution has the same properties as multiplication;

(c) Prove that Theorem 5.2.5 holds;

(d) Prove that  $f * \delta = \delta * f = f$ ;

(e) Prove that  $\partial(f * g) = (\partial f) * g = f * (\partial g)$ ;

(f) Prove that  $T_a(f * g) = (T_a f) * g = f * (T_a g)$  for operator of shift  $T_a$ ;

(g) Prove that  $\text{supp}(f * g) \subset \text{supp}(f) + \text{supp}(g)$  where *arithmetic sum* of two sets is defined as  $A + B := \{x + y : x \in A, y \in B\}$ .

*Remark 11.2.4.* (a) One can prove that if a linear map  $L : \mathcal{E}' \rightarrow \mathcal{D}'$  commutes with all shifts:  $T_a(Lf) = L(T_a f)$  for all  $f \in \mathcal{E}'$  then there exists  $g \in \mathcal{D}'$  such that  $L$  is an operator of convolution:  $Lf = g * f$ ;

(b) One can extend convolution if none of  $f, g$  has a compact support but some other assumption is fulfilled. For example, in one-dimensional case we can assume that either  $\text{supp}(f) \subset [a, \infty)$ ,  $\text{supp}(g) \subset [a, \infty)$  or that  $\text{supp}(f) \subset (-\infty, a]$ ,  $\text{supp}(g) \subset (-\infty, a]$ .

Similarly in multidimensional case we can assume that  $\text{supp}(f) \subset C$ ,  $\text{supp}(g) \subset C$  where  $C$  is a cone with angle  $< \pi$  at its vertex  $a$ .

### 11.2.5 Fourier series

**Definition 11.2.7.** (a) We call one-dimensional distribution  $f$  *periodic with period  $L$*  if  $f(x - L) = f(x)$ .

(b) More generally, let  $\Gamma$  be a lattice of periods (see Definition 4.B.1). We call distribution  $f$   $\Gamma$ -*periodic* if  $f(x - n) = f(x)$  for all  $n \in \Gamma$ .

Periodic distributions could be decomposed into Fourier series: in one-dimensional case we have

$$f = \sum_{-\infty < m < \infty} c_m e^{\frac{2\pi imx}{L}} \quad (11.2.9)$$

and in multidimensional case

$$f = \sum_{m \in \Gamma^*} c_m e^{im \cdot x} \quad (11.2.10)$$

where  $\Gamma^*$  is a dual lattice (see Definition 4.B.3).

To define coefficients  $c_m$  we cannot use ordinary formulae since integral over period (or elementary cell, again see the same definition) is not defined properly. Instead we claim that there exists  $\varphi \in \mathcal{D}$  such that

$$\sum_{n \in \Gamma} \varphi(x - n) = 1. \quad (11.2.11)$$

Indeed, let  $\psi \in \mathcal{D}$  be non-negative and equal 1 in some elementary cell. Then  $\varphi(x) = \psi(x) / (\sum_{n \in \Gamma} \psi(x - n))$  is an appropriate function.

Then

$$c_m = |\Omega|^{-1} (\varphi f)(e^{-im \cdot x}) \quad (11.2.12)$$

where  $|\Omega|$  is a volume of the elementary cell.



*Exercise 11.2.7.* (a) Find decomposition in Fourier series of one-dimensional distribution  $f = \sum_{-\infty < n < \infty} \delta(x - nL)$ ;

(b) Find Fourier transform of  $f$  defined in (a);

(c) Find the connection to Poisson summation formula (see Theorem 5.2.5).

(d) Find decomposition in Fourier series of  $d$ -dimensional distribution  $f = \sum_{n \in \Gamma} \delta(x - n)$ ;

(e) Find Fourier transform of  $f$  defined in (d);

(f) Find the connection to multidimensional Poisson summation formula (see Remark 5.2.A.3).

## 11.3 Applications of distributions

### 11.3.1 Linear operators and their Schwartz kernels

During this course we considered many linear operators: differential operators like  $u \rightarrow Lu := au_{xx} + 2bu_{xy} + cu$  and integral operators

$$u(x) \rightarrow (Lu)(x) := \int K(x, y)u(y) dy \quad (11.3.1)$$

(recall that solutions of IVP, BVP and IBVP for PDEs was often given in such form). For integral operators  $K(x, y)$  is called (*integral*) *kernel of operator  $L$*  (not to be confused with the *kernel of operator  $L$*  which is  $N(L) = \{u : Lu = 0\}$ ).

L. Schwartz proved a remarkable theorem showing that each linear operator is in some sense integral operator:

**Theorem 11.3.1.** (i) Let  $L : \mathcal{D}(\Omega_1) \mapsto \mathcal{D}'(\Omega_2)$  be a linear continuous operator (the latter means that if  $u_n \rightarrow u$  in  $\mathcal{D}(\Omega_1)$  then  $Lu_n \rightarrow Lu$  in  $\mathcal{D}'(\Omega_2)$ ). Then there exists a unique  $K \in \mathcal{D}'(\Omega_2 \times \Omega_1)$  such that for any  $u \in \mathcal{D}(\Omega_1)$  and  $v \in \mathcal{D}(\Omega_2)$

$$(Lu)(v) = K(v \otimes u) \quad (11.3.2)$$

with  $(v \otimes u)(x, y) = v(x)u(y)$  (then  $(v \otimes u) \in \mathcal{D}(\Omega_2 \times \Omega_1)$ ).

(ii) Conversely, if  $K \in \mathcal{D}'(\Omega_2 \times \Omega_1)$  then there exists a unique linear continuous operator  $L : \mathcal{D}(\Omega_1) \mapsto \mathcal{D}'(\Omega_2)$  such that (11.3.2) holds.

**Definition 11.3.1.** Such  $K$  is called *Schwartz kernel of operator  $L$* .

*Example 11.3.1.* (a) For integral operator (11.3.1) Schwartz kernel is  $K(x, y)$ ;

(b) For  $I : u \mapsto u$  Schwartz kernel is  $\delta(x - y)$ ;

(c) In 1-dimensional case for operator of differentiation  $u \mapsto u'$  Schwartz kernel is  $\delta'(x - y)$  (dimension is 1); similarly in multi-dimensional case  $\partial_{x_j} : u \mapsto u_{x_j}$  Schwartz kernel is  $\delta_{x_j}(x - y) = -\delta_{y_j}(x - y)$ .

(d) For higher order derivatives we have the same picture: In 1-dimensional case for operator of second differentiation  $u \mapsto u''$  Schwartz kernel is  $\delta''(x - y)$  (dimension is 1); similarly in multi-dimensional case  $\partial_{x_j}\partial_{x_k} : u \mapsto u_{x_j x_k}$  Schwartz kernel is  $\delta_{x_j x_k}(x - y) = -\delta_{x_j y_k}(x - y) = \delta_{y_j y_k}(x - y)$ .

More examples are coming.

## 11.3.2 Densities

In Physics you considered masses or charges at several points (*atom* masses or charges) and continuously distributed. In the Probability Theory the same was for probabilities. Continuously distributed masses, charges or probabilities had densities while atom masses, charges or probabilities had not.

*Remark 11.3.1.* For those who took Real Analysis: in fact densities were assigned only to *absolutely continuous*, not to *singular continuous* distributions. But it does not matter here.

The theory of distributions allows us a unified approach. Consider 1-dimensional case first. Let  $Q(x)$  be a charge of  $(-\infty, x)$ . Similarly, in probability theory let  $P(x)$  be a probability to fall into  $(-\infty, x)$ . Both  $Q(x)$  and  $P(x)$  are functions of distribution (of charge or probability). If they were smooth functions then their derivatives would be densities. But even if they are not we can differentiate them in the sense of distributions!

Similarly, in  $d$ -dimensional case for  $x = (x_1, x_2, \dots, x_d)$  we can introduce  $d$ -dimensional functions of distributions: let  $Q(x)$  be a charge of  $(-\infty, x_1) \times (-\infty, x_2) \times \dots \times (-\infty, x_d)$  or probability to fall into this set. Then

$$p(x) = \partial_{x_1}\partial_{x_2}\cdots\partial_{x_d}Q(x) \quad (11.3.3)$$

is a density.

*Example 11.3.2.* (a) For charge or probability  $q$  concentrated in a single point  $a$  the density is  $q\delta(x - a)$ . If charges  $q_1, \dots, q_N$  are concentrated in the points  $a_1, \dots, a_N$  then a density is  $\sum_{1 \leq n \leq N} q_n \delta(x - a_n)$ .

(b) If the charge or probability is concentrated on the plane  $\{x_1 = a_1\}$  but on this plane it is distributed with a density  $p(x_2, \dots, x_d)$  then  $d$ -dimensional density is  $\delta(x_1 - a_1)p(x_2, \dots, x_d)$ .

(c) We can “mix and match” continuously distributed and concentrated at points, lines and surfaces charges or probabilities which allows us in the equations involving densities not to distinguish between cases.

### 11.3.3 Laplace equation

We know that function  $g(x) = \begin{cases} |x|^{2-d} & d \neq 2, \\ \ln |x| & d = 2 \end{cases}$  satisfies Laplace equation as  $x \neq 0$ . Now we need to check what happens at  $x = 0$ . Namely, we need to calculate  $\Delta g$  in the sense of distributions and to do this we consider

$$g(\Delta\varphi) = \int g(x)\Delta\varphi(x) dx = \lim_{\varepsilon \rightarrow 0} \int_{\Omega_\varepsilon} g(x)\Delta\varphi(x) dx$$

where  $\Omega_\varepsilon = \mathbb{R}^d \setminus B(0, \varepsilon)$ . The same calculations as earlier in Subsection 7.2.2 show that it is equal to (we skip limit temporarily)

$$\int_{\Omega_\varepsilon} (\Delta g(x))\varphi(x) dx + \int_{S(0,\varepsilon)} \left[ (-\partial_r \varphi(x))g(x) + \varphi(x)\partial_r g(x) \right] d\sigma$$

and since  $\Delta g = 0$  in  $\Omega_\varepsilon$  the first term is 0 and the second one is

$$\int_{S(0,\varepsilon)} \left[ (-\varepsilon^{2-d}\partial_r \varphi(x)) + \underbrace{(2-d)\varepsilon^{1-d}} \varphi(x) \right] d\sigma$$

where for  $d = 2$  selected expression should be replaced by  $\varepsilon^{-1}$ . Taking the limit we see that since the area of  $S(0, \varepsilon)$  is  $\sigma_d \varepsilon^{-1}$  the first term disappears and the second becomes  $(2-d)\sigma_d \varphi(0)$  as  $d \neq 2$  and  $\sigma_2 \varphi(0)$  where  $\sigma_d$  is an “area” of  $S(0, 1)$ .

Therefore

$$\Delta G(x) = \delta(x) \tag{11.3.4}$$

where

$$G(x) = \begin{cases} -(d-2)^{-1} \sigma_d^{-1} |x|^{2-d} & d \neq 2, \\ (2\pi)^{-1} \ln |x| & d = 2 \end{cases}. \quad (11.3.5)$$

But then  $u = G * f$  solves  $\Delta u = f$  in  $\mathbb{R}^d$ . Indeed, as  $\Delta$  has constant coefficients and derivatives could be applied to any “factor” in the convolution  $\Delta(G * f) = (\Delta G) * f = \delta * f = f$ .

*Remark 11.3.2.* (a) We get  $G(x) = \frac{1}{2}|x|$  as  $d = 1$ ,  $G(x) = \frac{1}{2\pi} \ln |x|$  as  $d = 2$  and  $-\frac{1}{4\pi}|x|^{-1}$  as  $d = 3$ ;

(b) As  $d \geq 3$   $G(x)$  is a unique solution to (11.3.4) under additional condition  $G(x) = o(1)$  as  $|x| \rightarrow \infty$  (or  $G(x) = O(|x|^{2-d})$  as  $|x| \rightarrow \infty$ ;

(c) Up to a numerical factor one can guess  $G(x)$  (as  $d \geq 3$ ) from the following arguments:  $\delta(x)$  is spherically symmetric positive homogeneous of degree  $-d$ ,  $\Delta$  is spherically symmetric and it decreases degree of homogeneity by 2 so  $G$  must be spherically symmetric positive homogeneous of degree  $2 - d$ . These arguments fail as  $d = 2$  as because there is no unique natural solution (solutions differ by a constant).

*Remark 11.3.3.* As  $d = 3$  from Subsection 9.1.5 we can guess that  $G(x, \omega) = -\frac{1}{4\pi}|x|^{-1}e^{\mp i\omega|x|}$  solves Helmholtz equation with Sommerfeld radiating conditions

$$(\Delta + \omega^2)G = \delta(x), \quad (11.3.6)$$

$$G = o(1) \quad \text{as } |x| \rightarrow \infty, \quad (11.3.7)$$

$$(\partial_r \pm i\omega)G = o(r^{-1}) \quad \text{as } |x| \rightarrow \infty. \quad (11.3.8)$$

*Remark 11.3.4.* Similarly Green function  $G(x, y)$  for Dirichlet boundary problem in  $\Omega$  satisfies

$$\Delta_x G = \delta(x - y), \quad (11.3.9)$$

$$G|_{x \in \partial\Omega} = 0. \quad (11.3.10)$$

and Green function  $G(x, y)$  for Robin boundary problem in  $\Omega$  satisfies the same equation but with Robin boundary condition

$$(\partial_{\nu_x} + \alpha)G|_{x \in \partial\Omega} = 0. \quad (11.3.11)$$

Here  $x, y \in \Omega$ .

### 11.3.4 Diffusion equation

Consider Green function for diffusion equation in  $\mathbb{R}^d$ :

$$G(x, t) = (4\pi kt)^{-\frac{d}{2}} e^{-\frac{|x|^2}{4kt}}. \quad (11.3.12)$$

It satisfies diffusion equation  $G_t = k\Delta G$  as  $t > 0$  and as  $t \rightarrow 0$  it tends to  $\delta(x)$ .

Further, if we define

$$H^+(x, t) = \begin{cases} G(x, t) & t > 0, \\ 0 & t \leq 0 \end{cases} \quad (11.3.13)$$

we see that

$$(\partial_t - k\Delta)H^+(x, t) = \delta(x)\delta(t). \quad (11.3.14)$$

Similarly

$$G(x, t) = (4\pi k|t|)^{-\frac{d}{2}} e^{\mp \frac{id\pi}{4}} e^{-\frac{|x|^2}{4k|t|}} \quad \text{as } \pm t > 0 \quad (11.3.15)$$

satisfies Schrödinger equation  $G_t = ik\Delta G$  (even as  $t = 0$ ) and as  $t \rightarrow 0$  it tends to  $\delta(x)$ . Further, if we define

$$H^\pm(x, t) = \begin{cases} \pm G(x, t) & \pm t > 0, \\ 0 & \pm t \leq 0 \end{cases} \quad (11.3.16)$$

we see that

$$(\partial_t - ik\Delta)H^\pm(x, t) = \delta(x)\delta(t). \quad (11.3.17)$$

### 11.3.5 Wave equation

It follows from Kirchhoff formula (9.1.12) that

$$G(x, t) = \frac{1}{4\pi c^2 |t|} (\delta(|x| - ct) - \delta(|x| + ct)) \quad (11.3.18)$$

satisfies 3-dimensional wave equation  $G_{tt} - c^2\Delta G = 0$  and also

$$G(x, t)|_{t=0} = 0, \quad G_t(x, t)|_{t=0} = \delta(x). \quad (11.3.19)$$

It follows from (9.1.15) that

$$G(x, t) = \pm \frac{1}{2\pi c} (c^2 t^2 - |x - y|^2)_+^{-\frac{1}{2}} \quad (11.3.20)$$

satisfies 2-dimensional wave equation  $G_{tt} - c^2 \Delta G = 0$  and also (11.3.19); here  $z_+^\lambda = z^\lambda \theta(z)$ ; recall that  $\theta(z)$  is a Heaviside function.

Formulae (9.1.23) and (9.1.24) allow us to construct  $G(x, t)$  for odd  $d \geq 3$  and even  $d \geq 2$ .

Formula (2.3.14) (D'Alembert formula) allows us to construct as  $d = 1$ :

$$G(x, t) = \frac{1}{2c} (\theta(x + ct) - \theta(x - ct)). \quad (11.3.21)$$

Defining  $H^\pm(x, t)$  by (11.3.16) we get

$$(\partial_t^2 - c^2 \Delta) H^\pm(x, t) = \delta(x) \delta(t). \quad (11.3.22)$$

**Definition 11.3.2.** If  $H$  satisfies  $LH = \delta(x - y)$  it is called *fundamental solution* to  $L$ .

## 11.4 Weak solutions

### 11.4.1 Examples

Weak solutions occupy a place between ordinary regular solutions and solutions which are distributions, usually when the existence of the former is not proven (or proven yet, or does not have place) and the second do not make sense.

Weak solutions must satisfy certain integral identities which in some sense are equivalent to original equations.

*Example 11.4.1.* (a) Consider equation

$$\sum_{j,k} (a_{jk} u)_{x_j x_k} + \sum_j (b_j u)_{x_j} + cu = f \quad (11.4.1)$$

in domain  $\Omega$ . In the smooth case this equation is equivalent to

$$\iint_{\Omega} u \left( \sum_{j,k} a_{jk} \varphi_{x_j x_k} - \sum_j b_j \varphi_{x_j} + c\varphi \right) dx = \iint_{\Omega} f \varphi dx \quad (11.4.2)$$

for all  $\varphi \in C_0^2(\Omega)$  and we call  $u \in C(\Omega)$  (or even worse) *weak solution* to equation (11.4.1) in this case. Note that coefficients may be even discontinuous so we cannot plug into (11.4.1) distributions.

(b) Consider equation in the *divergent form*

$$\sum_{j,k} (a_{jk} u_{x_j})_{x_k} + \frac{1}{2} \sum_j [(b_j u)_{x_j} + b_j u_{x_j}] + cu = f \quad (11.4.3)$$

in domain  $\Omega$ . In the smooth case this equation is equivalent to

$$\iint_{\Omega} \left( \sum_{j,k} -a_{jk} u_{x_j} \varphi_{x_k} + \frac{1}{2} \sum_j [-b_j u \varphi_{x_j} + b_j u_{x_j} \varphi] + cu \varphi \right) dx = \iint_{\Omega} f \varphi dx \quad (11.4.4)$$

for all  $\varphi \in C_0^1(\Omega)$  and we call  $u \in C^1(\Omega)$  (or even worse) *weak solution* to equation (11.4.3) in this case. Note that coefficients may be even discontinuous so we cannot plug into (11.4.3) distributions.

*Example 11.4.2.* Consider equation (11.4.3) again but now we add condition

$$\left[ - \sum_{jk} a_{jk} u_{x_j} \nu_k - \frac{1}{2} \sum_j b_j u \nu_j \right] \Big|_{\Gamma} = h \quad (11.4.5)$$

where  $\nu_k$  are components of the unit inner normal to  $\Gamma$ . Then in the smooth case (11.4.3) and (11.4.5) together are equivalent to

$$Q[u, \varphi] = \iint_{\Omega} f \varphi dx + \int_{\Gamma} h \varphi dS \quad (11.4.6)$$

which should hold for all  $\varphi \in C^1(\mathbb{R}^d)$  (now  $\varphi$  is not necessarily 0 near  $\Gamma$ !) and we call  $u \in C^1(\Omega)$  (or even worse) *weak solution* to problem (11.4.3), (11.4.5) in this case. Here  $Q[u, \varphi]$  is the left-hand expression in (11.4.4).

These examples could be extended to quasilinear or even nonlinear equation. See Burgers equation in Section 12.1.

# Chapter 12

## Nonlinear equations

### 12.1 Burgers equation

#### 12.1.1 Two problems

Consider equation

$$u_t + f(u)u_x = 0, \quad t > 0 \quad (12.1.1)$$

Then we consider a problem

$$u(x, 0) = \begin{cases} u_- & x < 0, \\ u_+ & x > 0 \end{cases} \quad (12.1.2)$$

There are two cases:

*Case 1.*  $f(u_-) < f(u_+)$ . In this case characteristics

$$\frac{dt}{1} = \frac{dx}{f(u)} = \frac{du}{0} \quad (12.1.3)$$

originated at  $\{(x, 0): 0 < x < \infty\}$  fill domains  $\{x < f(u_-)t, t > 0\}$  where  $u = u_-$  and  $\{x > f(u_+)t, t > 0\}$  where  $u = u_+$  and leave sector  $\{f(u_-)t < x < f(u_+)t, t > 0\}$  empty. In this sector we can construct continuous self-similar solution  $u = g(x/t)$  and this construction is unique provided  $f$  is monotone function (say increasing)

$$f'(u) > 0 \quad (12.1.4)$$



(and then  $f(u_-) < f(u_+)$  is equivalent to  $u_- < u_+$ ). Namely

$$u(x, t) = \begin{cases} u_- & x < f(u_-)t, \\ g\left(\frac{x}{t}\right) & f(u_-)t < x < f(u_+)t, \\ u_+ & x > f(u_+)t \end{cases} \quad (12.1.5)$$

provides solution for (12.1.1)-(12.1.2) where  $g$  is an inverse function to  $f$ .

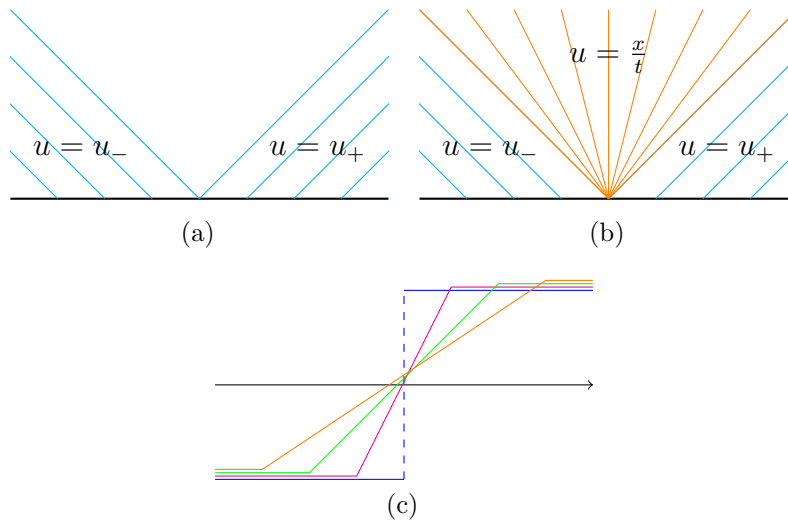

Figure 12.1: For  $f(u) = u$  as  $u_- < u_+$  characteristics and solution consecutive profiles (slightly shifted up)

Case 2.  $f(u_-) > f(u_+)$ . In this case characteristics collide

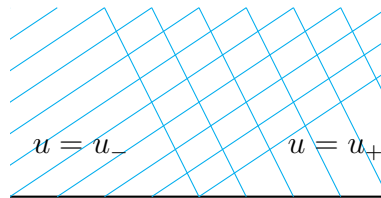

Figure 12.2: For  $f(u) = u$  as  $u_- > u_+$  characteristics collide

and to provide solution we need to reformulate our equation (12.1.1) as

$$u_t + (F(u))_x = 0, \quad t > 0 \quad (12.1.6)$$

where  $F(u)$  is a primitive of  $f$ :  $F'(u) = f(u)$ . Now we can understand equation in a weak sense and allow discontinuous (albeit bounded) solutions. So, let us look for

$$u = \begin{cases} u_- & x < st, \\ u_+ & x > st \end{cases} \quad (12.1.7)$$

where so far  $s$  is unknown. Then

$$\begin{aligned} u_t &= -s[u_+ - u_-]\delta(x - st), \\ u_x &= [F(u_+) - F(u_-)]\delta(x - st) \end{aligned}$$

where brackets contain jumps of  $u$  and  $F(u)$  respectively and (12.1.6) means exactly that

$$s = \frac{[F(u_+) - F(u_-)]}{u_+ - u_-} \quad (12.1.8)$$

which is equal to  $F'(v) = f(v)$  at some  $v \in (u_-, u_+)$  and due to (12.1.4)  $s \in (f(u_-), f(u_+))$ :

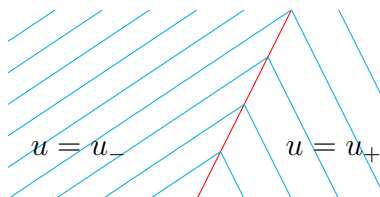
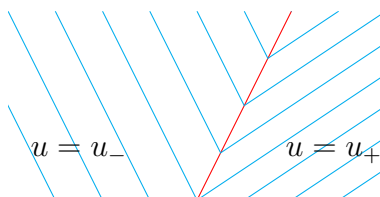

Figure 12.3: For  $f(u) = u$  as  $u_- < u_+$  characteristics and a line of jump (profiles are just shifted steps)

## 12.1.2 Shock waves

*Huston, we have a problem!!!* However allowing discontinuous solutions to (12.1.6) we opened a floodgate to many discontinuous solution and broke unicity. Indeed, let us return to Case 1 and construct solution in the same manner as in Case 2. Then we get (12.1.8)–(12.1.7) solution with  $s = F'(v)$  at some  $v \in (u_+, u_-)$  and due to (12.1.4)  $s \in (f(u_+), f(u_-))$ : So, we got two solutions: new discontinuous and old continuous (12.1.5). In fact, situation is much worse since there are many hybrid solutions in the form (12.1.8) albeit with discontinuous  $g$ . To provide a uniqueness we need to weed out all such solutions.



*Remark 12.1.1.* Equation (12.1.6) is considered to be a *toy-model* for gas dynamics. Discontinuous solutions are interpreted as *shock waves* and solution in Case 1 are considered *rarefaction waves*. Because of this was formulated principle *there are no shock rarefaction waves* which mathematically means  $u(x-0, t) \geq u(x+0, t)$  where  $u(x \pm 0, t)$  are limits from the right and left respectively. However it is not a good condition in the long run: for more general solutions these limits may not exist. To do it we multiply equation (12.1.1) by  $u$  and write this new equation

$$uu_t + f(u)u_x = 0, \quad t > 0 \quad (12.1.9)$$

in the divergent form

$$\left(\frac{1}{2}u^2\right)_t + (\Phi(u))_x = 0, \quad t > 0 \quad (12.1.10)$$

where  $\Phi(u)$  is a primitive of  $uf(u)$ .

*Remark 12.1.2.* Let us observe that while equations (12.1.1) and (12.1.9) are equivalent for continuous solutions, equations (12.1.6) and (12.1.10) are not equivalent for discontinuous ones. Indeed, for solution (12.1.7) the left-hand expression in (12.1.10) is

$$K\delta(x-st) \quad (12.1.11)$$

with

$$\begin{aligned} K(u_-, u_+) &= -s\frac{1}{2}[u_+^2 - u_-^2] + [\Phi(u_+) - \Phi(u_-)] = \\ &= -\frac{1}{2}(u_+ + u_-)[F(u_+) - F(u_-)] + [\Phi(u_+) - \Phi(u_-)] \end{aligned} \quad (12.1.12)$$

*Exercise 12.1.1.* Prove that  $K(u_-, u_+) \geq 0$  as  $u_+ \geq u_-$ . To do it consider  $K(u-v, u+v)$ , observe that it is 0 as  $v=0$  and  $\partial_v K(u-v, u+v) = v(f(u+v) - f(u-v)) > 0$  for  $v \neq 0$  due to (12.1.4).

So for “good” solutions

$$\left(\frac{1}{2}u^2\right)_t + (\Phi(u))_x \leq 0, \quad t > 0 \quad (12.1.13)$$

where we use the following

**Definition 12.1.1.** Distribution  $U \geq 0$  if  $U(\varphi) \geq 0$  for all non-negative test functions  $\varphi$ .

It was proven

**Theorem 12.1.1.** Assume that  $f'(u) > 0$ . Then solution to the problem (12.1.6), (12.1.2) with additional restriction (12.1.13) exists and is unique as  $\phi$  is **bounded total variation function**.

*Remark 12.1.3.* Restriction (12.1.13) is interpreted as *entropy cannot decrease*.

### 12.1.3 Examples

*Example 12.1.1.* The truly interesting example is Burgers equation ( $f(u) = u$ ) with initial conditions which are not monotone. So we take

$$u(x, 0) = \phi(x) := \begin{cases} 1 & x < -1, \\ -1 & -1 < x < 0, \\ 1 & x > 1. \end{cases} \quad (12.1.14)$$

Then obviously the solution is first provided by a combination of Case 1 and Case 2:

$$u(x, t) = \begin{cases} 1 & x < -1, \\ -1 & -1 < x < -t, \\ \frac{x}{t} & -t < x < t, \\ 1 & x > t. \end{cases} \quad (12.1.15)$$

This holds as  $0 < t < 1$  because at  $t > 1$  rarefaction and shock waves collide.

Now there will be a shock wave at  $x = \xi(t)$ ,  $t > 1$ . On its left  $u = 1$ , on its right  $u = \xi t^{-1}$  and therefore slope is a half-sum of those:

$$\frac{d\xi}{dt} = \frac{1}{2} + \frac{\xi}{2t}; \quad (12.1.16)$$

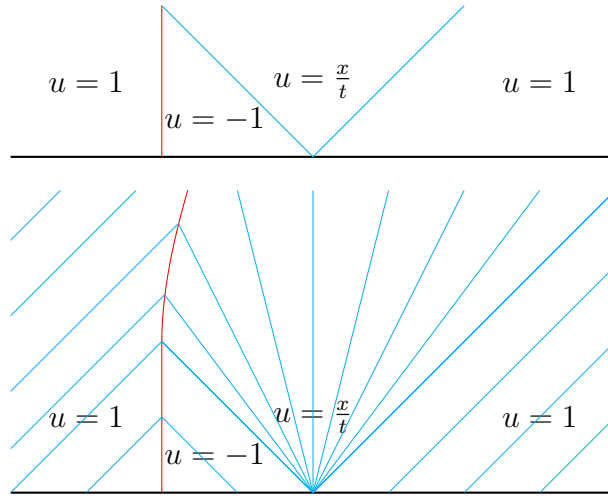

this ODE should be solved with initial condition  $\xi(1) = -1$  and we have  $\xi(t) = t - 2t^{\frac{1}{2}}$ .

Observe that

$$\begin{aligned} \max_{-\infty < x < \infty} u(x, t) &= 1, \\ \min_{-\infty < x < \infty} u(x, t) &= \xi(t)t^{-1} = 1 - 2t^{-\frac{1}{2}} \end{aligned}$$

and

$$\left( \max_{-\infty < x < \infty} u(x, t) - \min_{-\infty < x < \infty} u(x, t) \right) \rightarrow 0 \quad \text{as } t \rightarrow +\infty.$$

We can consider example with  $u(x, 0) = -\phi(x, 0)$  by changing  $x \mapsto -x$  and  $u \mapsto -u$ .

*Example 12.1.2.* Consider now

$$u(x, 0) = \phi(x) := \begin{cases} 2 & x < -1, \\ 0 & -1 < x < 1, \\ -2 & x > 1. \end{cases} \quad (12.1.17)$$

Then for  $0 < t < 1$ , we have two shock waves:

$$u(x, t) = \begin{cases} u_- & x < -1 + t, \\ u_0 & -1 + t < x < 1 - t, \\ u_+ & x > 1 - t \end{cases} \quad (12.1.18)$$

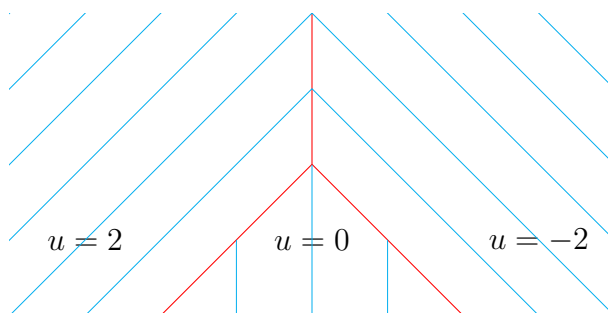

and for  $t = 1$  both shock waves collide at  $x = 0$  and then for  $t > 1$

$$u(x, t) = \begin{cases} 2 & x < 0, \\ -2 & x > 0. \end{cases} \quad (12.1.19)$$

### 12.1.4 Viscous approximation

One can prove that

**Theorem 12.1.2.** *Assume that  $f'(u) > 0$ . Then solution  $v = v(x, t, \varepsilon)$  of the problem*

$$v_t + uv_x = \varepsilon v_{xx}, \quad t > 0, -\infty < x < \infty \quad (12.1.20)$$

$$v|_{t=0} = f(x). \quad (12.1.21)$$

*converges (in the sense of distributions) to solution  $u(x, t)$  of (12.1.1) with the same initial  $u(x, 0) = f(x)$  condition as  $\varepsilon \rightarrow +0$ .*

We claim that this solution satisfies (12.1.13). Indeed, from (12.1.1) we conclude that

$$\left(\frac{1}{2}u^2\right)_t + (\Phi(u))_x = \varepsilon uu_{xx} = \varepsilon \left(\frac{1}{2}u^2\right)_{xx} - \varepsilon u_x^2;$$

applying it to test function  $\varphi \geq 0$  we pass to the limit in the left (requires justification) and in the first term on the right (also requires justification, results in 0) but the last term on the right is  $-\varepsilon u_x^2(\varphi)$  which results in  $\leq 0$  (but not necessarily equal).

It turns out that the convergence is uniform away from shockwave, but around shockwave appears a layer of the width of magnitude  $\varepsilon$  where convergence cannot be uniform (because there continuous and even infinitely smooth solution to the viscous Burgers equation (12.1.20) converges to the discontinuous one).

See [Section 9.1](#) and [Section 9.2](#) of the online textbook “Asymptotic and Perturbational Methods”.

# Chapter 13

## Eigenvalues and eigenfunctions

### 13.1 Variational theory

#### 13.1.1 Introduction

Consider quadratic forms

$$Q_0(u) = \|u\|^2 = \iiint_{\Omega} |u|^2 dx; \quad (13.1.1)$$

$$Q(u) = \iiint_{\Omega} \|\nabla u\|^2 dx + \iint_{\Sigma} \alpha |u|^2 d\sigma \quad (13.1.2)$$

where  $\Omega$  is a bounded domain with a smooth boundary  $\Sigma = \partial\Omega$ .

Let us consider a variational problem for  $Q(u)$  under restriction  $\|u\| = 1$  and

$$u|_{\Sigma^-} = 0 \quad (13.1.3)$$

where  $\Sigma^- \subset \Sigma$ .

Constructing functional  $Q_\lambda(u) = Q(u) - \lambda Q(u)$  and taking its variation we arrive at the Euler-Lagrange equation

$$-\Delta u = \lambda u \quad (13.1.4)$$

with the boundary conditions

$$u|_{\Sigma^-} = 0, \quad (\partial_\nu u - \alpha u)|_{\Sigma^+} = 0 \quad \Sigma^+ = \Sigma \setminus \Sigma^- \quad (13.1.5)$$

where  $\nu$  is a unit inner normal.

So we arrived at the eigenvalue problem. We need the following theorems from the Real Analysis:

**Theorem 13.1.1.** *Let  $\mathbf{H}$  be a Hilbert space. Let  $\|v_n\| \leq M$ ; then there exists a subsequence  $v_{n_k}$  which converges weakly in  $\mathbf{H}$ :  $(v_{n_k} - v, \phi) \rightarrow 0$  for all  $\phi \in \mathbf{H}$ .*

**Theorem 13.1.2.** *Let  $\Omega$  be a domain of a finite volume with a boundary  $\Sigma$ . Then any sequence  $v_n$  such that  $\|\nabla v_n\| \leq M$  and  $v_n|_{\Sigma} = 0$ , contains a subsequence  $v_{n_k}$  which converges in  $L^2(\Omega)$ :  $\|v_{n_k} - v\| \rightarrow 0$  for some  $v \in L^2(\Omega)$ ,  $\nabla v \in L^2(\Omega)$ .*

**Theorem 13.1.3.** *Let  $\Omega$  be a bounded domain with a smooth boundary. Then*

- (i)  $v \in L^2(\Omega)$ ,  $\nabla v \in L^2(\Omega)$  imply that  $v \in L^2(\Sigma)$ ;
- (ii) any sequence  $v_n$  such that  $\|v_n\| + \|\nabla v_n\| \leq M$  contains a subsequence  $v_{n_k}$  which converges in  $L^2(\Omega)$  and also converges in  $L^2(\Sigma)$ :  $\|v_{n_k} - v\|_{L^2(\Sigma)} \rightarrow 0$  to some  $v \in L^2(\Omega) \cap L^2(\Sigma)$ ,  $\nabla v \in L^2(\Omega)$ ;
- (iii) For any  $\epsilon > 0$  there exists  $C_\epsilon$  such that

$$\|v\|_{L^2(\Sigma)} \leq \epsilon \|\nabla v\| + C_\epsilon \|v\|. \quad (13.1.6)$$

*Remark 13.1.1.* Actually one need only assume that  $\Sigma^+$  is bounded and smooth.

## 13.1.2 Main variational principles

**Theorem 13.1.4.** *Let  $\Omega$  be a bounded domain with the smooth boundary. Then*

- (i) *There exists a sequence of eigenvalues  $\lambda_1 \leq \lambda_2 \leq \lambda_3 \leq \dots$ ,  $\lambda_k \rightarrow \infty$  and a sequence of corresponding eigenfunctions  $u_1, u_2, \dots$  which forms a basis in  $L^2(\Omega)$ ;*
- (ii) *Variational problem of minimizing  $Q(u)$  under constrains  $\|u\| = 1$  and (13.1.3) has solution  $u_1$  and this minimum is  $\lambda_1$ .*
- (iii) *Variational problem of minimizing  $Q(u)$  under constrains  $\|u\| = 1$ , (13.1.3) and  $(u, u_1) = (u, u_2) = \dots = (u, u_{n-1}) = 0$  has solution  $u_n$  and this minimum is  $\lambda_n$ .*



*Proof.* Let us prove first that  $u_1$  exists. Let us consider minimizing sequence  $v_m$  for  $Q(u)$  under constrain  $\|v_m\| = 1$ . Observe that due to Theorem 13.1.3(c)

$$\|\nabla v\|_{L^2(\Sigma)}^2 \leq (1 - \epsilon)Q(v) + C_\epsilon\|v\|^2. \quad (13.1.7)$$

Then we have  $\|v_m\| + \|\nabla v_m\| \leq M$  and in virtue of Theorem 13.1.1 and either Theorem 13.1.2 or Theorem 13.1.3 there is a subsequence  $v_{m_k}$  converging to some  $v$  both in  $L^2(\Omega)$  and weakly in  $\mathbf{K} = \{v: \|v\|_{\mathbf{K}} < \infty, u|_{\Sigma^-} = 0\}$  with  $\|v\|_{\mathbf{K}} = (C_0\|v\|^2 + Q(v))^{\frac{1}{2}}$ . Then  $\|v\| = 1$  and  $Q(v)$  is minimal. We skip the proof.

Similarly we prove existence  $\lambda_n, u_n$  by induction. Now we claim that  $\lambda_n \rightarrow \infty$ . Indeed if it is not the case then  $\|u_n\| = 1$  and  $\|\nabla u_n\| \leq M$  for some  $M$ ; then in virtue of either Theorem 13.1.2 or Theorem 13.1.3 there exists a subsequence  $u_{n_k}$  converging in  $L^2(\Omega)$  which is impossible since  $u_{n_k}$  are mutually orthogonal and  $\|u_{n_k} - u_{n_l}\|^2 = 2$  as  $k \neq l$ .

(i) (ii) Further, observe that  $u_n$  are orthogonal in  $\mathbf{K}$ . Let us prove that system  $u_n$  is complete in  $\mathbf{K}$ . If it is not the case then there exists  $u \in \mathbf{K}$  which is orthogonal to all  $u_n$ . But then  $(u_n, u)_{\mathbf{K}} = (-\Delta u_n, u) + C_0(u_n, u) = (\lambda_n + C_0)(u_n, u)$  and therefore  $u$  is orthogonal to all  $u_n$  in  $L^2(\Omega)$  as well. But then since  $\lambda_k \rightarrow \infty$  and  $Q(u) < \infty$  we conclude that  $u$  must appear as a minimizing element in the sequence which is the contradiction.

(iii) Finally,  $u_n$  is complete in  $L^2(\Omega)$  as well. It follows from completeness in  $\mathbf{K}$  and the fact that  $\mathbf{K}$  is dense in  $L^2(\Omega)$ . The latter proof is elementary but we skip it as well. □

*Remark 13.1.2.* If  $\Sigma = \Sigma^-$  we do not need to assume that  $\Sigma$  is smooth or even  $\Omega$  is bounded; it is sufficient to assume that it has a finite volume (but even this is not necessary!)

**Corollary 13.1.5.** *Consider  $n$ -dimensional subspace*

$L \subset \mathbf{H} = \{u \in C^1(u), u|_{\Sigma^-} = 0\}$ . Let  $\mu_n(L) = \max_{u \in L: \|u\|=1} Q(u)$ . Then

$$\lambda_n = \min_{L \subset \mathbf{H}: \dim(L)=n} \mu_n(L) = \min_{L \subset \mathbf{H}: \dim(L)=n} \max_{u \in L: \|u\|=1} Q(u) \quad (13.1.8)$$

*Proof.* If  $L$  is a span of  $u_1, \dots, u_n$  then  $\lambda_n(L) = \lambda_n$  so the right-hand expression is not greater than the left-hand one. On the other hand, if  $L$  is not a span of  $u_1, \dots, u_n$  then there exists  $u \in L, u \neq 0$  which is orthogonal to  $u_1, \dots, u_n$  and therefore  $Q(u) \geq \lambda_{n+1}\|u\|^2$ . □

### 13.1.3 Dependence on parameters

**Theorem 13.1.6.** (i) Eigenvalues  $\lambda_n = \lambda_n(\alpha)$  does not decrease as  $\alpha$  increases;

(ii) Eigenvalues  $\lambda_n = \lambda_n(\Sigma^-)$  does not decrease as  $\Sigma^-$  increases;

(iii) As  $\alpha \rightarrow +\infty$  these eigenvalues  $\lambda_n = \lambda_n(\alpha)$  tend to  $\lambda_{D,n}$  which are eigenvalues of Dirichlet problem (i.e. when  $\Sigma^- = \Sigma$ ).

*Proof.* (i) As  $\alpha$  increases then  $Q(u)$  also increases and then the right-hand expression in (13.1.6) cannot decrease.

(ii) As we increase  $\Sigma^-$  we make space  $\mathbf{H}$  only smaller and thus make smaller the choice of  $n$ -dimensional subspaces  $L$  so the right-hand expression in (13.1.6) cannot decrease.

(iii) Therefore  $\lambda_n \leq \lambda_{D,n}$ . Then as  $\alpha \rightarrow +\infty$  expressions  $\alpha \iint_{\Sigma} |u_n(\alpha)|^2 d\sigma$  are bounded by  $\lambda_{D,n}$  and therefore  $u|_{\Sigma} \rightarrow 0$ . Assume that  $\lambda_n(\alpha) \leq \mu_n$  for all  $\alpha$ . Then by means of Real Analysis one can prove that there is a sequence  $\alpha_k \rightarrow +\infty$  such that  $u_n(\alpha_k) \rightarrow v_n$  and  $\|\nabla v_n\|^2 \leq \mu_n$ ,  $v_n|_{\Sigma} = 0$  and  $\|v_n\| = 1$ . But then  $\mu_n \geq \lambda_n$ . Therefore  $\lambda_n = \mu_n$  and  $\lambda_n(\alpha) \rightarrow \lambda_{D,n}$ . □

### 13.1.4 Dependence on domain

Consider now *only* Dirichlet boundary problem.

**Theorem 13.1.7.** Eigenvalues  $\lambda_n = \lambda_{D,n}(\Omega)$  does not increase as  $\Omega$  increases.

*Proof.* If  $\Sigma^- = \Sigma$  we can identify  $\mathbf{H} = \mathbf{H}(\Omega)$  with  $\{u: \nabla u \in L^2(\mathbb{R}^d), u = 0 \text{ on } \mathbb{R}^d \setminus \bar{\Omega}\}$  where  $\bar{\Omega}$  is a closure of  $\Omega$ . Then

$$Q(u) = \int |\nabla u|^2 dx, \quad Q_0(u) = \int |u|^2 dx$$

with integrals taken over  $\mathbb{R}^d$ . Therefore as  $\Omega$  increases then  $\mathbf{H}(\Omega)$  increases and the choice of  $L$  increases, so the right-hand expression in (13.1.6) cannot increase. □

*Remark 13.1.3.* This statement holds only for Dirichlet eigenvalues.

**Theorem 13.1.8.** *Let vary  $\Omega$  by moving by  $h$  into direction of  $\nu$  (where  $h$  is a small function on  $\Sigma$ ). Then for a simple eigenvalue  $\lambda_n$*

$$\delta\lambda_{D,n} = \frac{1}{\|u_n\|^2} \int_{\Sigma} h |\partial_{\nu} u_n|^2 d\sigma. \quad (13.1.9)$$

*Proof.* Consider  $u_n + \delta u_n$  matching to a new domain. Since it must be 0 on the new boundary, modulo smaller terms we conclude that it is  $u_n + \delta u_n = -h\partial_{\nu} u_n$  on the old boundary  $\Sigma$  and since  $u_n = 0$  there we conclude that

$$\delta u_n = -h\partial_{\nu} u_n \quad \text{on } \Sigma. \quad (13.1.10)$$

On the other hand  $(\Delta + \lambda_n + \delta\lambda_n)(u_n + \delta u_n) = 0$  and then modulo smaller terms we conclude that

$$(\Delta + \lambda_n)\delta u_n = -\delta\lambda_n u_n. \quad (13.1.11)$$

Let us multiply by  $u_n$  and integrate over  $\Omega$ ; the left-hand expression becomes

$$\begin{aligned} \int_{\Omega} (\Delta + \lambda_n)\delta u_n \cdot u_n dx = \\ \int_{\Omega} \delta u_n \cdot (\Delta + \lambda_n)u_n dx - \int_{\Sigma} \partial_{\nu} \delta u_n \cdot u_n d\sigma + \int_{\Sigma} \delta u_n \cdot \partial_{\nu} u_n d\sigma = \\ - \int_{\Sigma} h |\partial_{\nu} u_n|^2 d\sigma \end{aligned} \quad (13.1.12)$$

where we used that  $(\Delta + \lambda_n)u_n = 0$ ,  $u_n|_{\Sigma} = 0$  and (13.1.10).

Meanwhile the right-hand expression becomes  $-\delta\lambda_n \|u_n\|^2$ . Since it must be equal to the right-hand expression of (13.1.12) we arrive to (13.1.9).  $\square$

## 13.2 Asymptotic distribution of eigenvalues

### 13.2.1 Introduction

We are interested how eigenvalues are distributed. We introduce eigenvalue distribution function  $N(\lambda)$  which is the number of eigenvalues (of operator  $-\Delta$ ) which are less than  $\lambda$ . In other words,

$$N(\lambda) = \max_{\lambda_n < \lambda} n \quad (13.2.1)$$

where  $\lambda_n$  are eigenvalues, or, using Corollary 13.1.5 we reformulate it as

**Definition 13.2.1.** Eigenvalue distribution function is

$$N(\lambda) = \max_{L \subset H: Q(v) < \lambda \|v\|^2 \quad \forall 0 \neq v \in L} \dim L \quad (13.2.2)$$

*Remark 13.2.1.* While these two definitions coincide in our particular case there is a huge difference: formula (13.2.1) counts only eigenvalues. However formula (13.2.2) takes into account also a *continuous spectrum*: this way defined  $N(\lambda)$  is  $+\infty$  if  $(-\infty, \lambda)$  contains (some) points of continuous spectrum. This definition is one wide, labelindent=0ptly used.

In the same way as Theorem 13.1.6 and Theorem 13.1.7 one can prove

**Theorem 13.2.1.** (i)  $N(\lambda; \alpha)$  does not increase as  $\alpha$  increases;

(ii)  $N(\lambda; \Sigma^-)$  does not increase as  $\Sigma^-$  increases;

(iii) As  $\alpha \rightarrow +\infty$   $N(\lambda; \alpha) \rightarrow N_D(\lambda)$  which is an eigenvalue counting function for Dirichlet problem (i.e. when  $\Sigma^- = \Sigma$ ).

(iv)  $N_D(\lambda; \Omega)$  does not decrease as  $\Omega$  increases.

## 13.2.2 Rectangular box

Consider rectangular box in  $\mathbb{R}^d$ :  $\Omega = \{x: 0 < x_1 < a_1, 0 < x_2 < a_2, \dots, 0 < x_d < a_d\}$  with Dirichlet or Neumann boundary conditions. Then separation of variables brings us eigenfunctions and eigenvalues

$$X_m = \sin\left(\frac{\pi m_1 x_1}{a_1}\right) \sin\left(\frac{\pi m_2 x_2}{a_2}\right) \cdots \sin\left(\frac{\pi m_d x_d}{a_d}\right), \quad (13.2.3)$$

$$\lambda_m = \pi^2 \left( \frac{m_1^2}{a_1^2} + \frac{m_2^2}{a_2^2} + \cdots + \frac{m_d^2}{a_d^2} \right) \quad m_1 \geq 1, \dots, m_d \geq 1 \quad (13.2.4)$$

for Dirichlet problem and

$$X_m = \cos\left(\frac{\pi m_1 x_1}{a_1}\right) \cos\left(\frac{\pi m_2 x_2}{a_2}\right) \cdots \cos\left(\frac{\pi m_d x_d}{a_d}\right), \quad (13.2.5)$$

$$\lambda_m = \pi^2 \left( \frac{m_1^2}{a_1^2} + \frac{m_2^2}{a_2^2} + \cdots + \frac{m_d^2}{a_d^2} \right) \quad m_1 \geq 0, \dots, m_d \geq 0 \quad (13.2.6)$$

for Neumann problem where  $m = (m_1, \dots, m_d) \in \mathbb{Z}^d$  in both cases.

*Exercise 13.2.1.* Prove it by separation of variables.

Therefore

**Theorem 13.2.2.** For rectangular box  $\Omega = \{x: 0 < x_1 < a_1, 0 < x_2 < a_2, \dots, 0 < x_d < a_d\}$

(i)  $N_D(\lambda)$  equals to the number of integer points (points with all integer coordinates) in the domain

$$E_-(\lambda) = \left\{ m = (m_1, \dots, m_d): m_1 > 0, m_2 > 0, \dots, m_d > 0, \right. \\ \left. \frac{m_1^2}{a_1^2} + \frac{m_2^2}{a_2^2} + \dots + \frac{m_d^2}{a_d^2} < \pi^{-2}\lambda \right\};$$

(ii)  $N_N(\lambda)$  equals to the number of integer points (points with all integer coordinates) in the domain

$$E_+(\lambda) = \left\{ m = (m_1, \dots, m_d): m_1 \geq 0, m_2 \geq 0, \dots, m_d \geq 0, \right. \\ \left. \frac{m_1^2}{a_1^2} + \frac{m_2^2}{a_2^2} + \dots + \frac{m_d^2}{a_d^2} < \pi^{-2}\lambda \right\}.$$

Calculation of the number of integer points in the “large” domains is an important problem of the *Number Theory*. For us the answer “the number of integer points inside of the large domain approximately equals to its volume” is completely sufficient but let us use the following

**Theorem 13.2.3.** As  $d \geq 2$  the number of integer points inside ellipsoid

$$\mathcal{E}(\lambda) = \left\{ m = (m_1, \dots, m_d): \frac{m_1^2}{a_1^2} + \frac{m_2^2}{a_2^2} + \dots + \frac{m_d^2}{a_d^2} < \pi^{-2}\lambda \right\}$$

equals to the volume of  $\mathcal{E}(\lambda)$  plus  $o(\lambda^{(d-1)/2})$ .

*Remark 13.2.2.* Actually much more precise results are known.

Observe that the volume of this ellipsoid  $\mathcal{E}(\lambda)$  is  $\pi^{-d}\omega_d a_1 a_2 \cdots a_d \lambda^{d/2}$  where  $\omega_d$  is a volume of the unit ball in  $\mathbb{R}^d$ .

*Exercise 13.2.2.* Prove it observing that ellipsoid  $\mathcal{E}(\lambda)$  is obtained by stretching of the unit ball.

Observe also that both  $E_+(\lambda)$  and  $E_-(\lambda)$  constitute  $1/2^d$  part of  $\mathcal{E}(\lambda)$  and therefore their volumes are  $(2\pi)^{-d}\omega_d a_1 \cdots a_d \lambda^{d/2}$ . However if we consider integer points we observe that

- (a) the number of integer points in  $E_-(\lambda)$  multiplied by  $2^d$  equals to the number of integer points in  $\mathcal{E}(\lambda)$  minus the number of integer points belonging to the intersection of  $\mathcal{E}(\lambda)$  with one of the planes  $\Pi_j = \{m = (m_1, \dots, m_d) : m_j = 0\}$  while
- (b) the number of integer points in  $E_+(\lambda)$  multiplied by  $2^d$  equals to the number of integer points in  $\mathcal{E}(\lambda)$  plus the number of integer points belonging to the intersection of  $\mathcal{E}(\lambda)$  with one of the planes  $\Pi_j = \{m = (m_1, \dots, m_d) : m_j = 0\}$ .

Actually, it is not completely correct as one needs to take into account intersections of  $\mathcal{E}(\lambda)$  with two different planes  $\Pi_j$  and  $\Pi_k$  but the number of integer points there is  $O(\lambda^{(d-2)/2})$ .

Since intersections of  $\mathcal{E}(\lambda)$  with  $\Pi_j$  is an ellipsoid we conclude that the number of integer points there is  $\pi^{1-d}\omega_{d-1}(a_1 a_2 \cdots a_d / a_j) \lambda^{(d-1)/2}$ .

Therefore the number of integer points in  $E_{\pm}(\lambda)$  is equal to

$$(2\pi)^{-d}\omega_d a_1 a_2 \cdots a_d \lambda^{d/2} \pm \frac{1}{2}(2\pi)^{1-d}\omega_{d-1} \underbrace{a_1 a_2 \cdots a_d (a_1^{-1} + a_2^{-1} + \dots + a_d^{-1})}_{\text{boundary area}} \lambda^{(d-1)/2} + o(\lambda^{(d-1)/2}).$$

Observe that  $a_1 a_2 \cdots a_d$  is a volume of  $\Omega$  and  $a_1 a_2 \cdots a_d (a_1^{-1} + a_2^{-1} + \dots + a_d^{-1})$  is a half of area of its boundary  $\partial\Omega$ .

So we arrive to

**Theorem 13.2.4.** For rectangular box  $\Omega = \{x : 0 < x_1 < a_1, 0 < x_2 < a_2, \dots, 0 < x_d < a_d\}$ ,  $d \geq 2$

$$N(\lambda) = (2\pi)^{-d} \text{mes}_d(\Omega) \lambda^{d/2} + O(\lambda^{(d-1)/2}) \quad (13.2.7)$$

and more precisely

$$N(\lambda) = (2\pi)^{-d} \text{mes}_d(\Omega) \lambda^{d/2} \pm \frac{1}{4} (2\pi)^{1-d} \text{mes}_{d-1}(\partial\Omega) \lambda^{(d-1)/2} + o(\lambda^{(d-1)/2}) \quad (13.2.8)$$

where “+” corresponds to Neumann and “−” to Dirichlet boundary conditions and  $\text{mes}_k$  means  $k$ -dimensional volume.

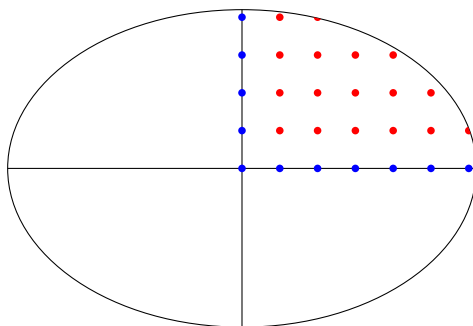

Figure 13.1: For Dirichlet boundary condition we do not count points with  $m_i = 0$  (blue) and for Neumann problem we count them.

*Remark 13.2.3.* (a) Asymptotics (13.2.7) holds for  $d = 1$  as well;

(b) Asymptotics (13.2.7) and (13.2.8) with the sign “+” hold for Robin boundary condition.

### 13.2.3 Weyl formula

Now we want to generalize these results for an arbitrary domain  $\Omega$ . To do so let us consider domain  $\Omega_\varepsilon^+$  which includes  $\Omega$  and all points on the distance  $\leq C\varepsilon$  from  $\partial\Omega$  and partition it into cubic boxes such that

- (a) The side of any box is at least  $\varepsilon$ ;
- (b) If the box is not inside of  $\Omega$  completely its side is exactly  $\varepsilon$ .

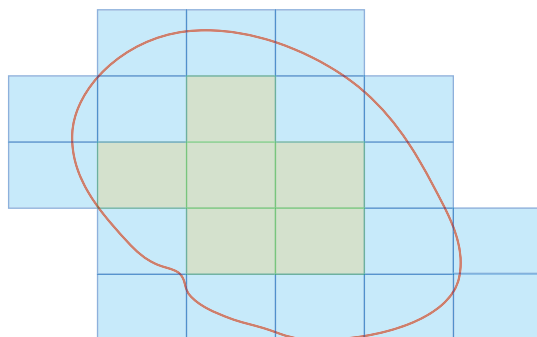

13.2: Inner and boundary boxes

The boxes which are completely inside of  $\Omega$  are called *inner boxes* and the boxes which intersect  $\partial\Omega$  are called *boundary boxes*.

We consider now *only* Dirichlet conditions. Let us use Definition 13.2.1 for  $N(\lambda)$ ; for Dirichlet boundary conditions we can consider  $\mathbf{H}$  as the space of all functions which vanish outside of  $\Omega$ .

Let us tighten constraints to these functions: we assume that they are 0 in the boundary boxes as well and that they vanish on the walls of all boxes. Then  $N(\lambda)$  can only decrease:  $N(\lambda) \geq N_*(\lambda)$  where  $N_*(\lambda)$  is an eigenvalue counting function under these new constraints. But under these constraints calculation in each box becomes independent and we arrive to

$$N_*(\lambda) = \left[ (2\pi)^{-d} \omega_d \lambda^{d/2} - c \lambda^{(d-1)/2} \varepsilon^{-1} \right] \sum_{\iota} \text{mes}_d(B_{\iota})$$

where we sum over all inner boxes. As  $\varepsilon \geq c_1 \lambda^{-1/2}$  this expression is greater than  $\left[ (2\pi)^{-d} \omega_d \lambda^{d/2} - c \lambda^{(d-1)/2} \varepsilon^{-1} \right] \text{mes}_d(\Omega_{\varepsilon}^-)$  where  $\Omega_{\varepsilon}^-$  is the set of all points of  $\Omega$  on the distance  $> \varepsilon$  from  $\partial\Omega$ . Thus

$$N_D(\lambda) \geq \left[ (2\pi)^{-d} \omega_d \lambda^{d/2} - c \lambda^{(d-1)/2} \varepsilon^{-1} \right] (\text{mes}_d(\Omega) - \text{mes}_d(\Omega \setminus \Omega_{\varepsilon}^-)). \quad (13.2.9)$$

Let us loosen constraints to these functions: we assume that they are arbitrary in the boundary boxes as well and that they can be discontinuous on the walls of all boxes (then  $Q(u)$  is calculated as a sum of  $Q_{\iota}(u)$  all over boxes). Then  $N(\lambda)$  can only increase:  $N(\lambda) \leq N^*(\lambda)$  where  $N^*(\lambda)$  is an eigenvalue counting function under these new constraints. But under these constraints calculation in each box becomes independent and we arrive to

$$N^*(\lambda) = \left[ (2\pi)^{-d} \omega_d \lambda^{d/2} + c \lambda^{(d-1)/2} \varepsilon^{-1} \right] \sum_{\iota} \text{mes}_d(B_{\iota})$$

where we sum over all inner and boundary boxes. Thus

$$N_D(\lambda) \leq \left[ (2\pi)^{-d} \omega_d \lambda^{d/2} + c \lambda^{(d-1)/2} \varepsilon^{-1} \right] (\text{mes}_d(\Omega) + \text{mes}_d(\Omega_{\varepsilon}^+ \setminus \Omega)). \quad (13.2.10)$$

But what is the gap between the right-hand expressions of (13.2.9) and (13.2.10)? It does not exceed

$$C \lambda^{(d-1)/2} \varepsilon^{-1} \text{mes}_d(\Omega_{\varepsilon}^+) + C \lambda^{d/2} \text{mes}_d(\Sigma_{\varepsilon})$$

where  $\Sigma_{\varepsilon}$  is the set of all points on the distance  $\leq C_0 \varepsilon$  from  $\Sigma = \partial\Omega$ .



We definitely want  $\text{mes}_d(\Sigma_\varepsilon) \rightarrow 0$  as  $\varepsilon \rightarrow +0$ . According to *Real Analysis* we say that it means exactly that  $\Sigma$  is a set of measure 0.

Thus we arrive to

**Theorem 13.2.5.** *If  $\Omega$  is a bounded domain and  $\partial\Omega$  is a set of measure 0 then*

$$N_D(\lambda) = (2\pi)^{-d}\omega_d\lambda^{d/2} + o(\lambda^{d/2}) \quad (13.2.11)$$

as  $\lambda \rightarrow +\infty$ .

*In particular, it holds if  $\Omega$  is a bounded domain and  $\partial\Omega$  is smooth.*

### 13.2.4 Remarks

*Remark 13.2.4.* (a) This Theorem 13.2.5 (in a bit less general form) was proven by H.Weyl in 1911;

(b) In fact we need neither of assumptions: even if  $\partial\Omega$  is not a set of measure 0 asymptotics (13.2.11) holds but in this case  $\text{mes}_d(\Omega)$  means a Lebesgue measure of  $\Omega$  (see *Real Analysis*).

(c) Further, as  $d \geq 3$  we can assume only that  $\text{mes}_d(\Omega) < \infty$ .

*Remark 13.2.5.* (a) We can always make a more subtle partition into cubic boxes: we can assume additionally that the size of the inner box  $B_\iota$  is of the same magnitude as a distance from  $B_\iota$  to  $\partial\Omega$ ; then we can get a remainder estimate

$$C\lambda^{(d-1)/2} \iiint_{\{x: \gamma(x) \geq c\lambda^{-1/2}\}} \gamma(x)^{-1} dx + C\lambda^{d/2}\text{mes}_d(\Sigma_{c\lambda^{-1/2}}) \quad (13.2.12)$$

where  $\gamma(x)$  is a distance from  $x$  to  $\Sigma = \partial\Omega$ .

(b) If  $\Omega$  is a bounded set and  $\partial\Omega$  is smooth then for Dirichlet and Robin boundary condition

$$N_D(\lambda) = (2\pi)^{-d}\omega_d\lambda^{d/2} + O(\lambda^{(d-1)/2} \ln \lambda). \quad (13.2.13)$$

(c) Even if the boundary is highly irregular one can define Neumann Laplacian. However in this case even if domain is bounded it can have non-empty continuous spectrum and then  $N_N(\lambda) = \infty$  for  $\lambda \geq C$ .

*Remark 13.2.6.* Let  $\Omega$  be bounded domain and  $\partial\Omega$  be smooth.

(a) Much more delicate proof based on completely different ideas shows that for Dirichlet and Robin boundary condition

$$N(\lambda) = (2\pi)^{-d}\omega_d\lambda^{d/2} + O(\lambda^{(d-1)/2}). \quad (13.2.14)$$

(b) Even more delicate proof shows that under some *billiard condition* asymptotics (13.2.8) holds with sign “+” for Robin boundary condition and “-” for Dirichlet boundary conditions.

(c) This billiard condition is believed to be fulfilled for any domain in  $\mathbb{R}^d$ . However it is not necessarily true on manifolds; for Laplacian on the sphere only (13.2.14) holds but (13.2.14) fails.

(d) Actually, one can allow Dirichlet boundary condition on some part of the boundary ( $\Sigma^-$ ) and Robin boundary condition on the remaining part of the boundary ( $\Sigma^+ = \Sigma \setminus \Sigma^-$ ) provided transition between those parts is regular enough. Then the formula becomes

$$N(\lambda) = (2\pi)^{-d}\text{mes}_d(\Omega)\lambda^{d/2} + \frac{1}{4}(2\pi)^{1-d}(\text{mes}_{d-1}(\Sigma^+) - \text{mes}_{d-1}(\Sigma^-))\lambda^{(d-1)/2} + o(\lambda^{(d-1)/2}) \quad (13.2.15)$$

(e) There are generalizations allowing some kinds or “regular singularities” of  $\partial\Omega$ .

*Remark 13.2.7.* There are many generalizations of these asymptotics; let us mention only few. We consider Schrödinger operator

$$H = -\hbar^2\Delta + V(x). \quad (13.2.16)$$

Then Weyl formula for this operator is

$$N(\lambda, \hbar) \approx (2\pi\hbar)^{-d}\omega_d \iiint (\lambda - V(x))_+^{d/2} dx \quad (13.2.17)$$

where  $z_+ = \max(z, 0)$ . This formula is justified

- (a) As  $\hbar \rightarrow +0$  and  $V(x) \geq \lambda + \epsilon$  as  $|x| \geq C$ ;
- (b) As  $\hbar$  is either fixed or tends to  $+0$  and  $\lambda \rightarrow +\infty$  provided  $V(x) \rightarrow +\infty$  as  $|x| \rightarrow \infty$ ;
- (c) As  $\hbar$  is either fixed or tends to  $+0$  and  $\lambda \rightarrow -0$  provided  $V(x) \rightarrow 0$  and  $|x|^2(-V(x))_+ \rightarrow \infty$  as  $|x| \rightarrow \infty$ .

## 13.3 Properties of eigenfunctions

### 13.3.1 Base state

We assume that  $\Omega$  is connected domain. Consider the lowest eigenvalue  $\lambda_1$  and a corresponding eigenfunction  $u_1$ .

**Theorem 13.3.1.** *Let  $\Omega$  be a connected domain. Then*

- (a) *Eigenfunction  $u_1$  does not change its sign;*
- (b)  *$\lambda_1$  is a simple eigenvalue.*

*Proof.* (i) Let  $v = |u_1|$ . Observe that  $\|v\| = \|u_1\|$  and  $Q(v) = Q(u_1)$ . Then  $|u_1| = v$  is also an eigenfunction corresponding to eigenvalue  $\lambda_1$  and then  $u_{1,\pm} = \frac{1}{2}(|u_1| \pm u_1) = \max(\pm u_1, 0)$  are also eigenfunctions corresponding to  $\lambda_1$ . At least one of these two eigenfunctions, say  $u_{1,+}$  is positive on some open set  $\Omega' \subset \Omega$  and then  $u_{1,-} = 0$  on  $\Omega'$ . However  $(\Delta + \lambda_1)u_{1,-} = 0$  and there are many different theorems implying that since  $u_{1,-} = 0$  on  $\Omega'$  it must be 0 on  $\Omega$ . (For example: solutions of  $(\Delta + \lambda_1)v = 0$  are analytic functions and there for analytic functions there is a unique continuation theorem.) Then  $u_1 \geq 0$  in  $\Omega$ .

(ii) If  $u_1$  and  $v_1$  are two linearly independent eigenfunctions corresponding to the same lowest eigenvalue  $\lambda_1$ , then one can find  $w_1 = u_1 + \alpha v_1$  which also is an eigenfunction and  $(u_1, w_1) = 0$  which is impossible since both of them have constant signs in  $\Omega$  and therefore  $u_1 w_1$  has a constant sign in  $\Omega$  and does not vanish identically in virtue of argument of (a). □

*Remark 13.3.1.* (a) Let  $\lambda_1 \geq 0$ . Assuming that  $u_1 \geq 0$  we see that  $u_1$  is superharmonic function ( $\Delta u_1 \leq 0$ ) but such functions cannot reach minimum inside domain unless constant. So  $u_1 > 0$  in  $\Omega$ .

(b) Let  $\lambda_1 < 0$ . Assuming that  $u_1 \geq 0$  we see that  $u_1$  is subharmonic function ( $\Delta u_1 \geq 0$ ) and such functions cannot reach maximum inside domain unless constant.

(c) While  $\lambda_1$  is always simple,  $\lambda_n$  with  $n \geq 2$  may be multiple.

**Corollary 13.3.2.**  *$u_n$  with  $n \geq 2$  changes sign.*

Indeed, it is orthogonal to  $u_1$  which does not change a sign.

### 13.3.2 Nodal sets

**Definition 13.3.1.** Let  $u_n$  be an eigenfunction. Then  $\{x: u_n(x) = 0\}$  is called a *nodal set* (*nodal line* as  $d = 2$ ) and connected components of  $\{x \in \Omega, u_n(x) \neq 0\}$  are called *nodal domains*.

We know that for  $n = 1$  is just one nodal domain and for  $n \geq 2$  there are at least 2 nodal domains. We need the following theorem from *Ordinary Differential Equations*:

**Theorem 13.3.3.** For  $d = 1$  there are exactly  $n - 1$  nodal points and  $n$  nodal intervals for  $u_n$ .

**Theorem 13.3.4.** For  $d \geq 2$  if  $u$  is an eigenfunction with an eigenvalue  $\lambda_n$  then  $u_n$  has no more than  $n$  nodal domains.

*Proof.* Let  $u$  have  $m \geq n$  nodal domains. Consider  $w_k$  coinciding with  $u$  in  $k$ -th nodal domain  $\Omega_k$  of  $u$ . Then  $w_1, \dots, w_m$  are linearly independent and

$$\begin{aligned} \|c_1 w_1 + \dots + c_m w_m\|^2 &= \sum_{1 \leq j \leq m} c_j^2 \|w_j\|^2, \\ Q(c_1 w_1 + \dots + c_m w_m) &= \sum_{1 \leq j \leq m} c_j^2 Q(w_j). \end{aligned}$$

Consider the space  $L$  of linear combinations of  $w_1, \dots, w_m$  which are orthogonal to  $u_1, \dots, u_{n-1}$ ; then  $L \neq \{0\}$ . By definition  $Q(v) \geq \lambda_n \|v\|^2$  on  $L$ . Since  $u \in L$  we conclude that  $Q(u) \geq \lambda_n \|u\|^2$ ; however  $Q(u) = \lambda \|u\|^2$  and then  $\lambda \geq \lambda_n$ . It proves theorem if  $\lambda_{n+1} > \lambda_n$ .

Observe that since  $(\Delta + \lambda_n)w_k = 0$  in  $\Omega_k$  and  $w_k = 0$  in  $\Omega \setminus \Omega_k$  we integrating by parts see that  $Q(w_k) = \lambda_n \|w_k\|^2$  for all  $k$ . Then  $Q(v) = \lambda_n \|v\|^2$  for all  $v \in L$ .

Assume now that  $m > n$ . Then there exists  $0 \neq v \in L$  which is a linear combination of  $w_1, \dots, w_n$ . Then  $v$  is an eigenfunction but it is 0 in  $\Omega_{n+1}$  and therefore it must be 0. Contradiction.

Therefore if  $\lambda_{n-1} < \lambda_n = \dots = \lambda_m$  then each eigenfunction corresponding to multiple eigenvalue  $\lambda_n$  has no more than  $n$  nodal domains.

Then we can use it in the case when variables are separated (we consider only  $d = 2$  and only Dirichlet boundary condition:

*Example 13.3.1.* Let  $\Omega = \{0 < x < a, 0 < y < b\}$  be a rectangular box. Let us separate variables; then

$$u_{pq} = \sin\left(\frac{p\pi x}{a}\right) \sin\left(\frac{q\pi y}{b}\right), \quad \mu_{pq} = \pi^2 \left(\frac{p^2}{a^2} + \frac{q^2}{b^2}\right). \quad (13.3.1)$$

Then nodal lines form a rectangular grid (see below). Let  $a = b = \pi$ .

(a) Then  $\lambda_1 = 2$  and  $\lambda_2 = \lambda_3 = 10$  (where  $\lambda_n$  are  $\mu_{pq}$  ordered). First figure shows nodal lines for  $u_{21}$  (and nodal lines for  $u_{12}$  are exactly like this but flipped over  $x = y$ ). Consider now linear combinations of  $u_{21}$  and  $u_{12}$ ;

(b) Next  $\lambda_4 = 8$ ;

(c) Further,  $\lambda_5 = \lambda_6 = 10$ . First figure shows nodal lines for  $u_{31}$  (and nodal lines for  $u_{13}$  are exactly like this but flipped over  $x = y$ ). Consider now linear combinations of  $u_{31}$  and  $u_{13}$ ; Comparing two last pictures we see that crossing opens under small perturbations.

(d) Further,  $\lambda_7 = \lambda_8 = 13$ , First figure shows nodal lines for  $u_{32}$  (and nodal lines for  $u_{23}$  are exactly like this but flipped over  $x = y$ ). Consider now linear combinations of  $u_{32}$  and  $u_{23}$ ;

(e) Further,  $\lambda_9 = \lambda_{10} = 17$ , First figure shows nodal lines for  $u_{41}$  (and nodal lines for  $u_{14}$  are exactly like this but flipped over  $x = y$ ). Consider now linear combinations of  $u_{41}$  and  $u_{14}$ ;

(f) Further,  $\lambda_{11} = 18$  is simple  $p = q = 3$  and thus trivial; furthermore  $\lambda_{12} = \lambda_{13} = 20$  with  $p = 4, q = 2$  is also trivial: we need just to take any picture for  $p = 2, q = 1$  and make its double mirror reflection (we do not draw  $u_{pq}$  anymore).

(g) Further,  $\lambda_{14} = \lambda_{15} = 25$  does not produce anything much different from (d) but simply more nodal domains:

(h) Further,  $\lambda_{16} = \lambda_{17} = 26$ ;

(i) Skipping  $\lambda_{18} = \lambda_{19} = 29, \lambda_{20} = 32, \lambda_{21} = \lambda_{22} = 34$ , consider  $\lambda_{23} = \lambda_{24} = 37$ .

(j) Starting from  $\lambda = 50 = 7^2 + 1^2 = 5^2 + 5^2$  multiplicities could be larger than 2 and the following gallery is just a tiny sample

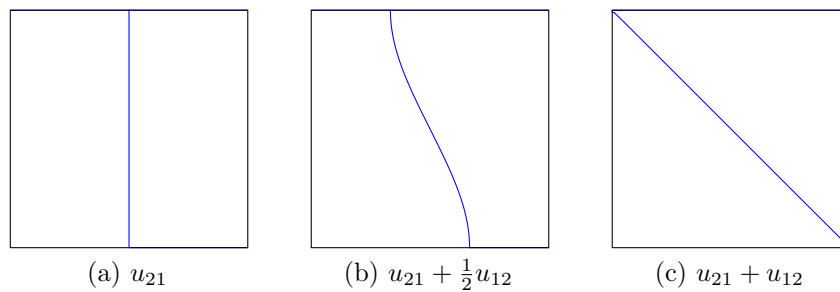

Figure 13.3:  $\lambda = 5$

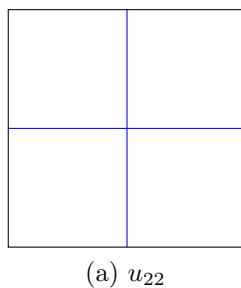

Figure 13.4:  $\lambda = 8$

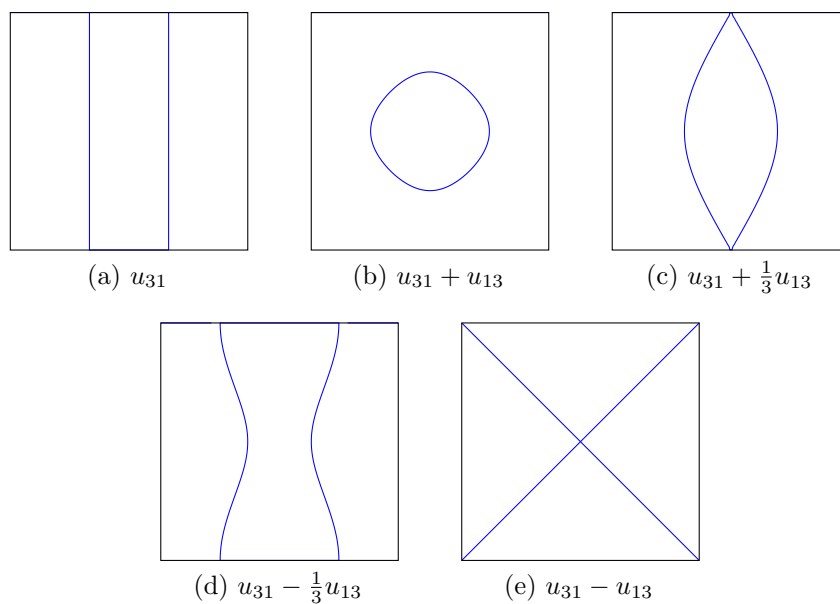

Figure 13.5:  $\lambda = 10$

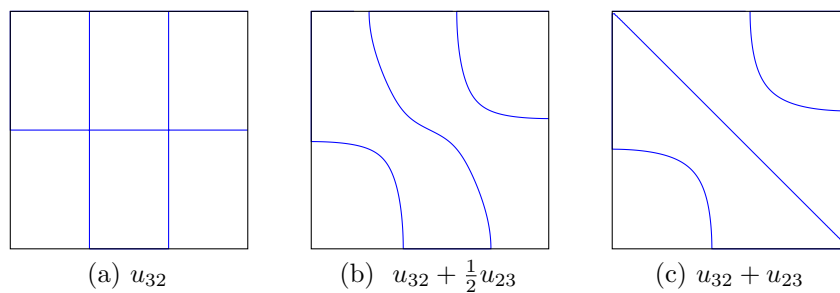

Figure 13.6:  $\lambda = 13$

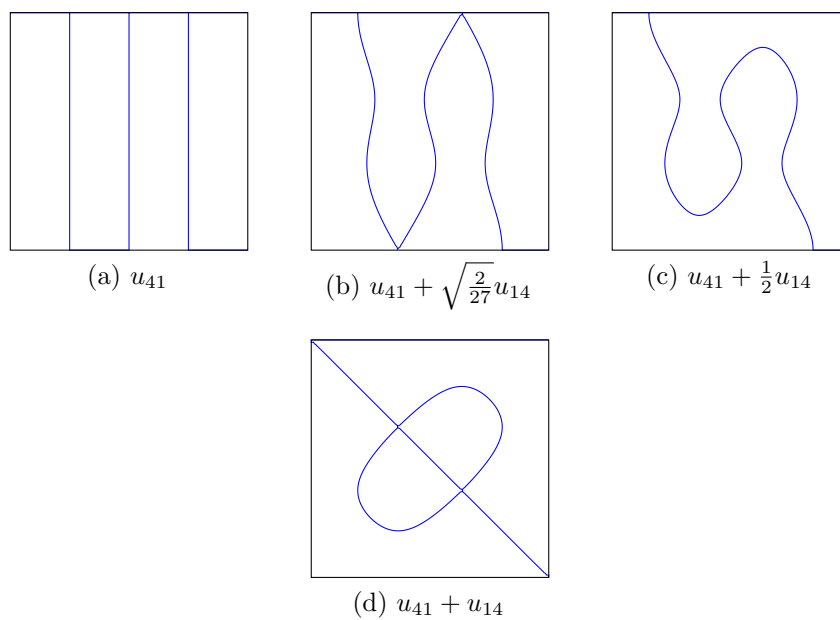

Figure 13.7:  $\lambda = 17$

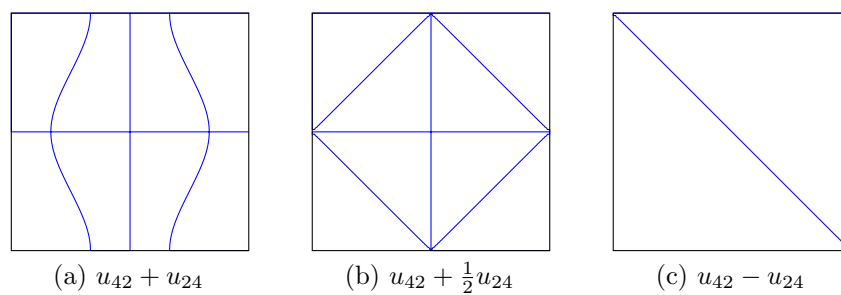

Figure 13.8:  $\lambda = 20$

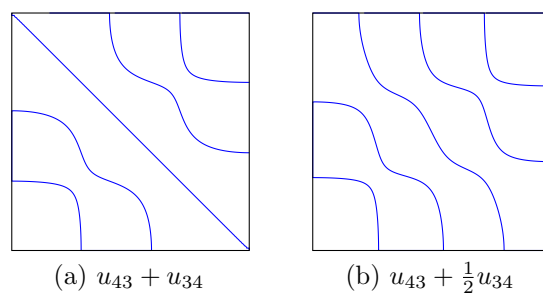

Figure 13.9:  $\lambda = 25$



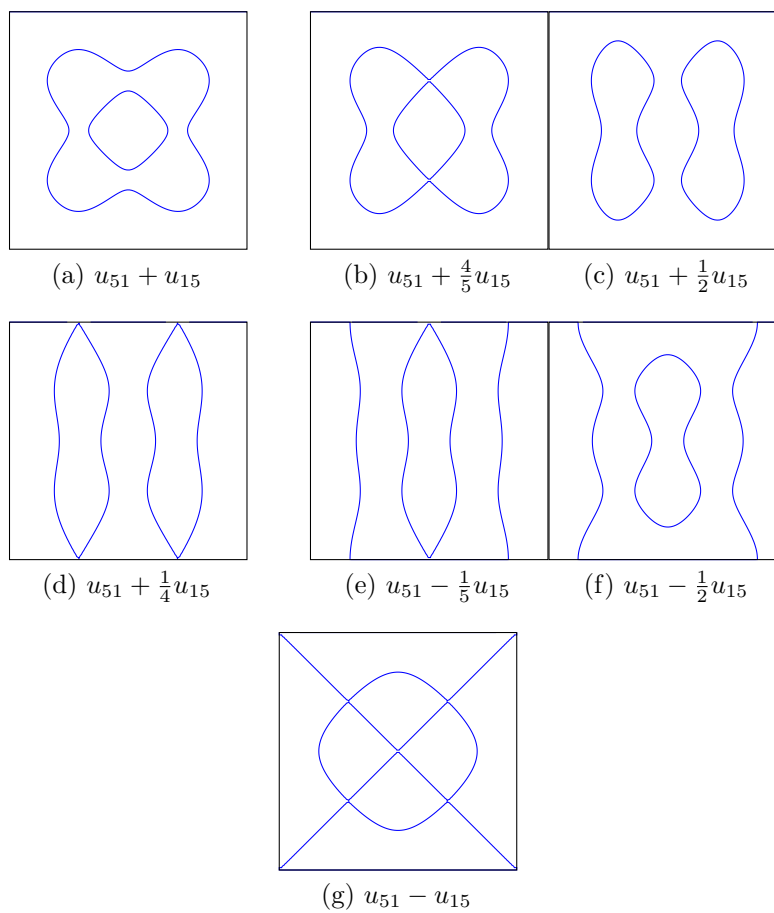

Figure 13.10:  $\lambda = 26$

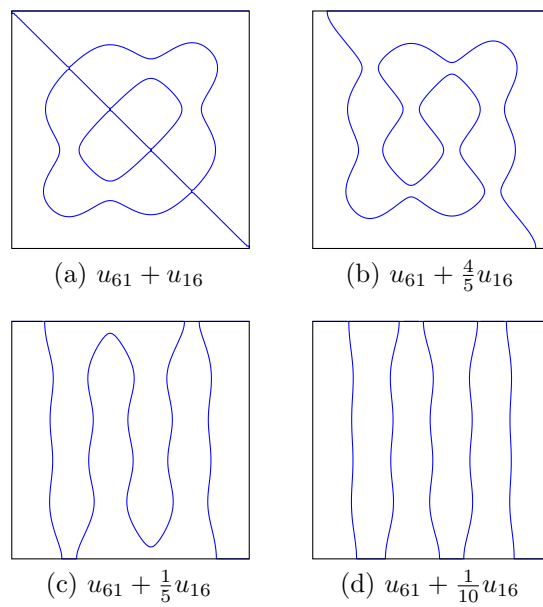

Figure 13.11:  $\lambda = 37$

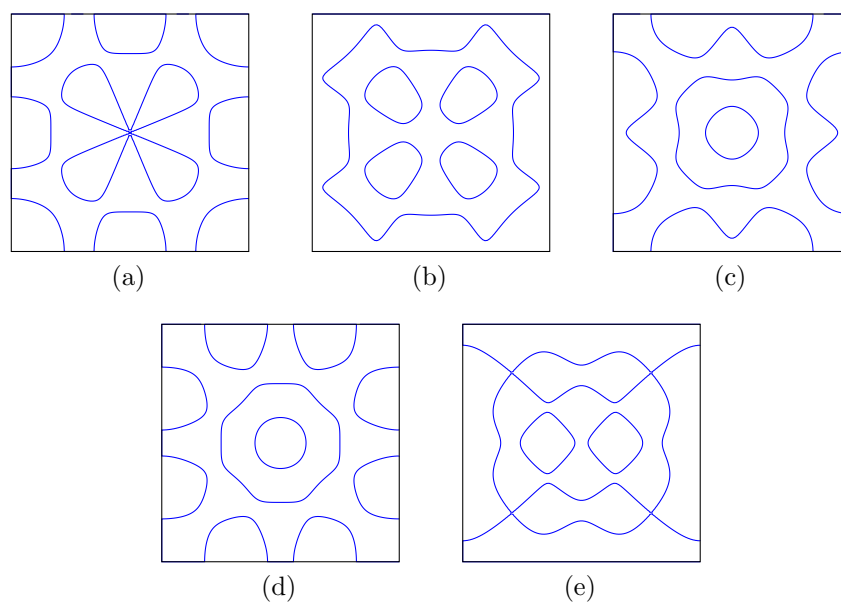
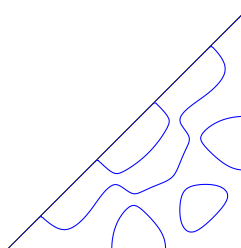

Figure 13.12:  $\lambda = 50$

*Example 13.3.2.* Consider  $\Omega = \{0 < y < x < \pi\}$  which is a triangle.

(a) If on the diagonal  $x = y$  a Dirichlet condition is required, then eigenfunctions are  $u_{pq}(x, y) - u_{pq}(y, x)$  with  $p \neq q$  (or their linear combination like  $u_{83}(x, y) - u_{83}(y, x)$  and  $u_{74}(x, y) - u_{74}(y, x)$ ).

(b) If on the diagonal  $x = y$  a Neumann condition is required, then eigenfunctions are  $u_{pq}(x, y) + u_{pq}(y, x)$  (or their linear combination like  $u_{71}(x, y) + u_{71}(y, x)$  and  $u_{55}(x, y)$ ).



(a)

*Example 13.3.3.* (a) Let  $\Omega = \{r \leq b\}$  be a disk. Then nodal lines form a circular grid:  $u_{pq}(r, \theta) = \cos(p\theta)J_p(k_{pq}r)$  where  $J_p(z)$  are Bessel functions and  $k_{pq}b$  is  $q$ -th root of  $J_p(z)$ . The similar statement is true for circular sectors, rings etc.

(b) Let  $\Omega$  be an ellipse. Then (see 6.3.3) in the elliptical coordinates Laplacian is

$$\Delta = \frac{1}{c^2(\sinh^2(\sigma) + \sin^2(\tau))}(\partial_\sigma^2 + \partial_\tau^2) \quad (13.3.2)$$

and separating variables  $u = S(\sigma)T(\tau)$  we get

$$S''' + (\lambda c^2 \sinh^2(\sigma) - k)S = 0, \quad (13.3.3)$$

$$T'' + (\lambda c^2 \sin^2(\tau) + k)T = 0. \quad (13.3.4)$$

For  $T$  we have either  $\pi$ -periodic or  $\pi$ -antiperiodic boundary condition:  $T(\tau + \pi) = \pm T(\tau)$  and for  $S$  we have Dirichlet boundary condition as  $\cosh(\sigma) = a/c$  and respectively Neumann and Dirichlet boundary condition as  $\sigma = 0$  arising from  $S(\pm\sigma) = \pm S(\sigma)$ . So we have a grid consisting from confocal ellipses and hyperbolas. The similar statement is true for elliptical “sectors”, rings etc.

(c) Let  $\Omega$  be an parabolic lense. Then (see Subsection 6.3.3) in the parabolic coordinates

$$\Delta = \frac{1}{\sigma^2 + \tau^2}(\partial_\sigma^2 + \partial_\tau^2) \quad (13.3.5)$$

and separating variables  $u = S(\sigma)T(\tau)$  we get

$$S'' + (\lambda\sigma^2 - k)S = 0, \quad (13.3.6)$$

$$T'' + (\lambda c^2\tau^2 + k)T = 0. \quad (13.3.7)$$

So we have a grid consisting from confocal parabolas.

*Remark 13.3.2.* For generic domains (any sufficiently small perturbation of generic domain is a generic domain again but an arbitrarily small perturbation of non-generic domain may result in generic domain)

- (a) All eigenvalues are simple;
- (b) Nodal lines do not have self-intersections.

*Remark 13.3.3.* Historically interest to nodal lines appeared from [Chladni plates](#) but those are nodal lines for biharmonic operator

$$(\Delta^2 - \lambda)u = 0 \quad (13.3.8)$$

with free boundary conditions (appearing from variational problem

$$\delta \left( \iint (u_{xx}^2 + 2u_{xy}^2 + u_{yy}^2 - \lambda u^2) dx dy \right) = 0 \quad (13.3.9)$$

(without boundary conditions). This is much more complicated question which was (partially) solved by [Marie-Sophie Germain](#).

For such equation works Fourier method: we can decompose solutions into Fourier series by  $\theta$  and for coefficients  $R_n(r)$  we get equation

$$\left( \partial_r^2 - \frac{1}{r} \partial_r - \frac{n^2}{r^2} - \omega \right) \left( \partial_r^2 - \frac{1}{r} \partial_r - \frac{n^2}{r^2} + \omega \right) R_n = 0 \quad (13.3.10)$$

$\omega = \sqrt{\lambda}$ , and we get nodal lines corresponding to zeroes either of  $\Theta_n$  (radial) or  $R_n$  (circular).

### 13.3.3 Hearing the shape of the drum

In 1966 Marc Kac asked the question “Can one hear the shape of the drum” which meant: if we know all the eigenvalues of the Dirichlet Laplacian  $\Delta$ :  $0 < -\lambda_1 < -\lambda_2 \leq \lambda_3 \leq \dots$  in the connected domain  $\Omega$ , can we restore  $\Omega$  (up to isometric movements—shift and rotations). The extensive study was using the method of *spectral invariants*, which are numbers which have some geometric meaning and which can be calculated from  $0 < -\lambda_1 < -\lambda_2 \leq \lambda_3 \leq \dots$ .

The main source of such invariants was the *method of heat equation*: Namely let  $G(x, y, t)$  with  $x, y \in \Omega$  and  $t > 0$  be a Green function:

$$G_t - \Delta_x G = 0, \quad (13.3.11)$$

$$G|_{t=0} = \delta(x - y), \quad (13.3.12)$$

$$G|_{x \in \partial\Omega} = 0 \quad (13.3.13)$$

and let

$$\sigma(t) = \iint u(x, x, t) dx = \sum_{n \geq 1} e^{-\lambda_n t} \quad (13.3.14)$$

be a *heat trace*; then

$$\sigma(t) \sim \sum_{k \geq -d} c_k t^{k/2} \quad \text{as } t \rightarrow +0 \quad (13.3.15)$$

where  $c_k$  are heat invariants. It was proven that (as  $d = 2$ , for  $d \geq 3$  similarly) area, perimeter, number of holes and many other geometric characteristic are spectral invariants but the final answer was negative: there are *isospectral* domains  $\Omega$  and  $\Omega'$  (so that eigenvalues of Laplacians in those are equal) which are not *isometric* (have different shapes).

## 13.4 About spectrum

### 13.4.1 Definitions and classification

#### Definitions

Let  $H$  be a Hilbert space (see Definition 4.3.3).

**Definition 13.4.1.** Linear operator  $L : \mathbf{H} \rightarrow \mathbf{H}$  is *bounded* if

$$\|Lu\| \leq M\|u\| \quad \forall u \in \mathbf{H}; \quad (13.4.1)$$

the smallest constant  $M$  for which it holds is called *operator norm* of  $L$  and denoted  $\|L\|$ .

**Definition 13.4.2.** Let  $L : \mathbf{H} \rightarrow \mathbf{H}$  be a bounded linear operator.

(a) Adjoint operator  $L^*$  is defined as

$$(Lu, v) = (u, L^*v) \quad \forall u, v \in \mathbf{H}; \quad (13.4.2)$$

(b) Operator  $L$  is *self-adjoint* if  $L^* = L$ .

However one needs to consider also unbounded operators. Such operators not only fail (13.4.1) but they are not defined everywhere.

**Definition 13.4.3.** Consider a linear operator  $L : D(L) \rightarrow \mathbf{H}$  where  $D(L)$  is a linear subset in  $\mathbf{H}$  (i.e. it is a linear subspace but we do not call it this way because it is not closed) which is *dense* in  $\mathbf{H}$  (i.e. for each  $u \in \mathbf{H}$  there exists a sequence  $u_n \in D(L)$  converging to  $u$  in  $\mathbf{H}$ ). Then

(a) Operator  $L$  is *closed* if  $u_n \rightarrow u$ ,  $Lu_n \rightarrow f$  imply that  $u \in D(L)$  and  $Lu = f$ ;

(b) Operator  $L$  is *symmetric* if

$$(Lu, v) = (u, Lv) \quad \forall u, v \in D(L); \quad (13.4.3)$$

(c) Symmetric operator  $L$  is *self-adjoint* if  $(L \pm i)^{-1} : \mathbf{H} \rightarrow D(L)$  exist:  $(L \pm i)(L \pm i)^{-1} = I$ ,  $(L \pm i)^{-1}(L \pm i) = I$  (identical operator)

*Remark 13.4.1.* (a) For bounded operators “symmetric” equals “self-adjoint”;

(b) Not so for unbounded operators. F.e.  $Lu = -u''$  on  $(0, l)$  with  $D(L) = \{u(0) = u'(0) = u(l) = u'(l) = 0\}$  is symmetric but not self-adjoint;

(c) Self-adjoint operators have many properties which symmetric but not self-adjoint operators do not have;

(d) In Quantum Mechanics *observables* are self-adjoint operators.

**Theorem 13.4.1.** *The following statements are equivalent:*

- (i)  $L$  is self-adjoint;
- (ii)  $L$  generates unitary group  $e^{itL}$  ( $t \in \mathbb{R}$ :  $\|e^{itL}u\| = \|u\|$ ,  $e^{i(t_1+t_2)L} = e^{it_1L}e^{it_2L}$ ,  $u \in D(L) \implies e^{itL}u \in D(L)$ ,  $\frac{d}{dt}e^{itL}u = Le^{itL}u$  for all  $u \in D(L)$  (and conversely, if  $e^{itL}u$  is differentiable by  $t$  then  $u \in D(L)$ );
- (iii) Exist spectral projectors – operators  $\theta(\tau - L)$  ( $\theta(\tau) = 0$  as  $\tau \leq 0$  and  $\theta(\tau) = 1$  as  $\tau > 0$ ) such that  $\theta(\tau - L)$  are orthogonal projectors,  $\theta(\tau_1 - L)\theta(\tau_2 - L) = \theta(\tau - L)$  with  $\tau = \min(\tau_1, \tau_2)$ ,  $\theta(\tau - L)u \rightarrow 0$  as  $\tau \rightarrow -\infty$ ;  $\theta(\tau - L)u \rightarrow u$  as  $\tau \rightarrow +\infty$ ;  $\theta(\tau - L)u \rightarrow \theta(\tau^* - L)u$  as  $\tau \rightarrow \tau^* - 0$  and

$$f(L) = \int f(\tau)d_\tau\theta(\tau - L) \quad (13.4.4)$$

**Definition 13.4.4.** Let us consider operator  $L$  (bounded or unbounded). Then

- (a)  $z \in \mathbb{C}$  belongs to the *resolvent set* of  $L$  if  $(L - z)^{-1} : \mathbf{H} \rightarrow D(L)$  exists and is a bounded operator:  $(L - z)^{-1}(L - z) = I$ ,  $(L - z)(L - z)^{-1} = I$ .
- (b)  $z \in \mathbb{C}$  belongs to the *spectrum* of  $L$  if it does not belong to its resolvent set. We denote spectrum of  $L$  as  $\sigma(L)$ .

*Remark 13.4.2.* (a) Resolvent set is always open (and spectrum is always closed) subset of  $\mathbb{C}$ ;

- (b) If  $L$  is self-adjoint then  $\sigma(L) \subset \mathbb{R}$ ;
- (c) If  $L$  is bounded then  $\sigma(L)$  is a bounded set.

### Classification

*Not all points of the spectrum are born equal!* From now on we consider only self-adjoint operators.

**Definition 13.4.5.** (a)  $z \in \mathbb{C}$  is an *eigenvalue* if there exists  $u \neq 0$  s.t.  $(A - z)u = 0$ . Then  $u$  is called *eigenvector* (or *eigenfunction* depending on context) and  $\{u : (A - z)u = 0\}$  is an *eigenspace* (corresponding to

eigenvalue  $z$ ). The dimension of the eigenspace is called a *multiplicity* of  $z$ . Eigenvalues of multiplicity 1 are *simple*, eigenvalues of multiplicity 2 are *double*,  $\dots$ , but there could be eigenvalues of infinite multiplicity!

- (b) The set of all eigenvalues is called *pure point spectrum*;
- (c) Eigenvalues of the finite multiplicity which are isolated from the rest of the spectrum form a *discrete spectrum*; the rest of the spectrum is called *essential spectrum*.

**Definition 13.4.6.**  $z \in \mathbb{C}$  belongs to *continuous spectrum* if  $z$  is not an eigenvalue and inverse operator  $(L - z)^{-1}$  exists but is not a bounded operator (so its domain  $D((L - z)^{-1})$  is dense).

*Remark 13.4.3.* Continuous spectrum could be classified as well. The difference between *absolutely continuous* and *singular continuous* spectra will be illustrated but one can define also multiplicity of continuous spectrum as well. However one needs a *Spectral Theorem* to deal with these issues properly.

## 13.4.2 Spectrum: examples

*Example 13.4.1.* Schrödinger operator

$$L = -\frac{1}{2}\Delta + V(x) \quad (13.4.5)$$

with potential  $V(x) \rightarrow +\infty$  as  $|x| \rightarrow \infty$  has a discrete spectrum: its eigenvalues  $E_n \rightarrow +\infty$  have finite multiplicities. In dimension  $d = 1$  all these eigenvalues are simple, not necessarily so as  $d \geq 2$ .

*Example 13.4.2.* Consider Laplacian on 2-dimensional sphere which appears after separation of variables for Laplacian in  $\mathbb{R}^3$  in spherical coordinates in Subsection 6.3.2. Then  $-\Delta$  has a spectrum  $\{E_n = n(n + 1) : n = 0, 1, \dots\}$ ;  $E_n$  is an eigenvalue of multiplicity  $(2n + 1)$ . Corresponding eigenfunctions are *spherical harmonics*. See Definition 8.1.1.

*Example 13.4.3.* Schrödinger operator in 2D with a constant magnetic and no electric field

$$L = \frac{1}{2}(-i\partial_x - \frac{1}{2}By)^2 + \frac{1}{2}(-i\partial_y + \frac{1}{2}By)^2 \quad (13.4.6)$$



with  $B > 0$  (or  $B < 0$ ) has a pure point spectrum. Eigenvalues  $E_n = |B|(n + \frac{1}{2})$ ,  $n = 0, 1, 2, \dots$  have infinite multiplicity and are called *Landau levels*.

*Example 13.4.4.* “Free” particle Schrödinger operator  $L = -\frac{1}{2}\Delta$  in  $\mathbb{R}^d$  has a continuous spectrum  $[0, +\infty)$ .

*Example 13.4.5.* Schrödinger operator (13.4.5) with potential  $V(x) \rightarrow 0$  as  $|x| \rightarrow \infty$  has a continuous spectrum  $[0, +\infty)$  but it can have a finite or infinite number of negative eigenvalues  $E_n < 0$ .

- (a) If  $|V(x)| \leq M(|x| + 1)^{-m}$ ,  $m > 2$  the number of eigenvalues is finite.
- (b) For *Coulomb potential*  $V(x) = -Z|x|^{-1}$  ( $Z > 0$ )  $E_n = -\frac{Z^2}{4n^2}$  of multiplicity  $n^2$ ,  $n = 1, 2, \dots$

*Example 13.4.6.* Free particle *Dirac operator*

$$L = \sum_{j=1}^3 \gamma^j (-i\partial_{x_j}) + \gamma^0 m, \quad m > 0 \quad (13.4.7)$$

(where  $\gamma^j$  are *Dirac matrices* has a continuous spectrum  $(-\infty, -m] \cup [m, \infty)$ . Perturbing it by a potential  $V(x)$ ,  $V(x) \rightarrow 0$  as  $|x| \rightarrow \infty$

$$L = \sum_{j=1}^3 \gamma^j (-i\partial_{x_j}) + m\gamma^0 + V(x)I, \quad m > 0 \quad (13.4.8)$$

can add a finite or infinite number of eigenvalues in *spectral gap*  $(-m, m)$ . They can accumulate only to the borders of the spectral gap.

*Example 13.4.7.* Perturbing Example 13.4.3 by a potential  $V(x)$ ,  $V(x) \rightarrow 0$  as  $|x| \rightarrow \infty$

$$L = \frac{1}{2}(-i\partial_x - \frac{1}{2}By)^2 + \frac{1}{2}(-i\partial_y + \frac{1}{2}Bx)^2 + V(x) \quad (13.4.9)$$

breaks Landau levels into sequences of eigenvalues  $E_{n,k}$ ,  $n = 0, 1, \dots$ ,  $k = 1, 2, \dots$ ,  $E_{n,k} \rightarrow E_n = |B|(n + \frac{1}{2})$  as  $k \rightarrow \infty$ .

*Example 13.4.8.* Consider Schrödinger operator (13.4.5) with periodic potential in  $\mathbb{R}^d$ :  $V(x+a) = V(x)$  for all  $a \in \Gamma$  where  $\Gamma$  is a *lattice of periods*, see Definition 4.B.1. Then  $L$  has a *band spectrum*.

Namely on the *elementary cell* (Definition 4.B.3)  $\Omega$  consider operator  $L(k)$  where  $k \in \Omega^*$  is a *quasimomentum*;  $L(k)$  is given by the same formula as  $L$  but is defined on functions which are *quasiperiodic with quasimomentum*  $k$ . Its spectrum is discrete:  $\sigma(L(k)) = \{E_n(k) : n = 1, 2, \dots\}$ .

Then spectrum  $\sigma(L)$  consists of *spectral bands*

$$\sigma_n := [\min_{k \in \Omega^*} E_n(k), \max_{k \in \Omega^*} E_n(k)], \quad (13.4.10)$$

$$\sigma(L) = \bigcup_{n=1}^{\infty} \sigma_n; \quad (13.4.11)$$

these spectral bands can overlap. The spectrum  $\sigma(L)$  is continuous.

1. As dimension  $d = 1$  we can do better than this:  $E_n(k)$  are increasing (decreasing) functions of  $k$  on  $(0, \pi/a)$  (where  $a$  is the period) as  $n$  is odd (respectively even) and

$$E_n^* := \max_{k \in [0, \pi/a]} E_n(k) \leq E_{(n+1)^*} := \min_{k \in [0, \pi/a]} E_{n+1}(k) \quad (13.4.12)$$

and for *generic potential*  $V(x)$  all inequalities are strict and all *spectral gaps*  $(E_n^*, E_{(n+1)^*}^*)$  are open.

2. As dimension  $d \geq 2$  only finite number of spectral gaps could be open.
3. Perturbation of such operator  $L$  by another potential  $W(x)$ ,  $W(x) \rightarrow 0$  as  $|x| \rightarrow \infty$  could add a finite or infinite number of eigenvalues in *spectral gaps*. They can accumulate only to the borders of the spectral gaps.

*Example 13.4.9.* In the space  $\ell^2(\mathbb{Z})$  (which is the space of sequences  $u_n$ ,  $n = \dots, -2, -1, 0, 1, 2, \dots$  such that  $\|u\|^2 := \sum_{n=-\infty}^{\infty} |u_n|^2 < \infty$ ) consider *almost Mathieu operator* (which appears in the study of *quantum Hall effect*).

$$(Lu)_n = u_{n+1} + u_{n-1} + 2\lambda \cos(2\pi(\theta + n\alpha)) \quad (13.4.13)$$

with  $|\lambda| \leq 1$ . Assume that  $\alpha$  is a *Diophantine number* (which means it is an irrational number which cannot be approximated well by rational numbers; almost all irrational numbers (including all algebraic like  $\sqrt{2}$ ) are Diophantine).

Then the spectrum  $\sigma(L)$  is continuous (no eigenvalues!) but it is *singular continuous*: for any  $\varepsilon > 0$  it can be covered by the infinite sequence of segments of the total length  $< \varepsilon$ . As an example of such set see *Cantor set*.

*Remark 13.4.4.* (a) Example 13.4.8 was completely investigated only in the end of the 20-th century.

(b) Example 13.4.9 was completely investigated only in the 21-st century.

### 13.4.3 Spectrum: explanations

#### Landau levels

Consider Example 3: Schrödinger operator in 2D with a constant magnetic and no electric field

$$L = \frac{1}{2}(-i\partial_x - \frac{1}{2}By)^2 + \frac{1}{2}(-i\partial_y + \frac{1}{2}By)^2 \quad (13.4.14)$$

with  $B > 0$  (or  $B < 0$ ) has a pure point spectrum. For simplicity assume that  $B > 0$ . We apply a *gauge transformation* which for Schrödinger operator means multiplying it from the left and right by  $e^{i\hbar^{-1}\phi(x)}$  and  $e^{-i\hbar^{-1}\phi(x)}$  respectively with a real-valued  $\phi$  (which is an unitary transformation) and replaces  $-i\hbar\nabla$  by  $-i\hbar\nabla - (\nabla\phi)$  (which is equivalent to changing vector potential  $\mathbf{A}(x)$  by  $\nabla\phi$  which in turn does not change  $\nabla \times \mathbf{A}$ ). Taking  $\hbar = 1$  and  $\phi = \frac{1}{2}Bxy$  we arrive to

$$L' = \frac{1}{2}(-i\partial_x - By)^2 + \frac{1}{2}(-i\partial_y)^2;$$

then making Fourier transform by  $x \mapsto \xi$  we get

$$L'' = \frac{1}{2}(-\xi - By)^2 + \frac{1}{2}(-i\partial_y)^2;$$

and plugging  $y = B^{-\frac{1}{2}}(y_{\text{new}} - B^{-1}\xi)$  we get

$$\frac{1}{2}B(-\partial_y^2 + y^2)$$

which is a harmonic oscillator multiplied by  $B$  and in virtue of Section 4.5.6 its spectrum consists of eigenvalues  $E_n = |B|(n + \frac{1}{2})$ ,  $n = 0, 1, 2, \dots$  which are called *Landau levels*.

However there is a “hidden variable”  $\xi$ , so eigenfunctions Hermite functions of  $y$  but multiplied by arbitrary functions  $C(\xi)$  rather than by constants which implies that these eigenvalues have constant multiplicities.

## Band spectrum

Consider Example 13.4.8: Schrödinger operator with periodic potential in  $\mathbb{R}^d$ :  $V(x+a) = V(x)$  for all  $a \in \Gamma$  where  $\Gamma$  is a lattice of periods.

Let us decompose function  $u(\mathbf{x})$  into  $n$ -dimensional Fourier integral

$$u(x) = \iiint_{\mathbb{R}^n} e^{i\mathbf{k}\cdot\mathbf{x}} \hat{u}(\mathbf{k}) d^n \mathbf{k},$$

then replace this integral by a sum of integrals over dual elementary cell  $\Omega^*$  shifted by  $\mathbf{n} \in \Gamma^*$

$$\sum_{\mathbf{n} \in \Gamma^*} \iiint_{\Omega^* + \mathbf{n}} e^{i\mathbf{k}\cdot\mathbf{x}} \hat{u}(\mathbf{k}) d^n \mathbf{k},$$

then change variable  $\mathbf{k} = \mathbf{k}_{\text{new}} + \mathbf{n}$

$$\iiint_{\Omega^*} e^{i(\mathbf{k}+\mathbf{n})\cdot\mathbf{x}} \underbrace{\left( \sum_{\mathbf{n} \in \Gamma^*} e^{i\mathbf{n}\cdot\mathbf{x}} \hat{u}(\mathbf{k} + \mathbf{n}) \right)}_{=U(\mathbf{k},\mathbf{x})} d^n \mathbf{k},$$

we observe that  $U(\mathbf{k}, \mathbf{x})$  is quasiperiodic with quasimomentum  $\mathbf{k}$ .

In advanced Real Analysis it would be a decomposition of our Hilbert space  $\mathbf{H} = L^2(\mathbb{R}^n)$  into *direct integral of Hilbert spaces*  $\mathbf{H}(\mathbf{k})$  of such functions, and our operator is acting in each of those spaces separately, with a spectrum  $\sigma(L(\mathbf{k})) = \{E_n(\mathbf{k}) : n = 1, 2, \dots\}$ . This implies that  $L$  has a *band spectrum*: it consists of *spectral bands*  $\sigma_n := [\min_{\mathbf{k} \in \Omega^*} E_n(\mathbf{k}), \max_{\mathbf{k} \in \Omega^*} E_n(\mathbf{k})]$ :

$$\sigma(L) = \bigcup_{n=1}^{\infty} \sigma_n;$$

these spectral bands can overlap. One can prove that  $E_n(\mathbf{k})$  really depend on  $\mathbf{k}$  and are not taking the same value on some set of *non-zero measure* (another notion from Real Analysis) which implies that the spectrum  $\sigma(L)$  is continuous.

## 13.5 Continuous spectrum and scattering

### 13.5.1 Introduction

Here we discuss idea of scattering. Basically there are two variants of the *Scattering Theory*—non-stationary and stationary. We start from the former

but then fall to the latter. We assume that there is *unperturbed operator*  $L_0$  and *perturbed operator*  $L = L_0 + V$  where  $V$  is a perturbation. It is always assumed that  $L_0$  has only continuous spectrum (more precisely—absolutely continuous) and the same is true for  $L$  (otherwise our space  $\mathbf{H}$  is decomposed into sum  $\mathbf{H} = \mathbf{H}_{ac} \oplus \mathbf{H}_{pp}$  where  $L$  acts on each of them and on  $\mathbf{H}_{ac}$ ,  $\mathbf{H}_{pp}$  it has absolutely continuous and pure point spectra respectively. Scattering happens only on the former.

Now consider  $u = e^{itL}u_0$  be a solution of the perturbed non-stationary equation. In the reasonable assumptions it behaves as  $t \rightarrow \pm\infty$  as solutions of the perturbed non-stationary equation:

$$\|e^{itL}u_0e^{itL_0}u_{\pm}\| \rightarrow 0 \quad \text{as } t \rightarrow \pm\infty \quad (13.5.1)$$

or, in other words the following limits exist

$$u_{\pm} = \lim_{t \rightarrow \pm\infty} e^{-itL_0}e^{itL}u_0. \quad (13.5.2)$$

Then operators  $W_{\pm} : u_0 \rightarrow u_{\pm}$  are called *wave operators* and under some restrictions they are proven to be unitary operators from  $\mathbf{H}$  onto  $\mathbf{H}_{ac}$ . Finally  $S = W_+W_-^{-1}$  is called a *scattering operator*.

Despite theoretical transparency this construction is not very convenient and instead are considered some test solutions which however do not belong to space  $\mathbf{H}_{ac}$ .

### 13.5.2 One dimensional scattering

Let us consider on  $\mathbf{H} = L^2(\mathbb{R})$  operators  $L_0u := -u_{xx}$  and  $L = L_0 + V(x)$ . Potential  $V$  is supposed to be fast decaying as  $|x| \rightarrow \infty$  (or even compactly supported). Then consider a solution of

$$u_t = iLu = -iu_{xx} + V(x)u \quad (13.5.3)$$

of the form  $e^{ik^2t}v(x, k)$ ; then  $v(x, k)$  solves

$$v_{xx} - V(x)v + k^2v = 0 \quad (13.5.4)$$

and it behaves as  $a_{\pm}e^{ikx} + b_{\pm}e^{-ikx}$  as  $x \rightarrow \pm\infty$ .

Consider solution which behaves exactly as  $e^{ikx}$  as  $x \rightarrow -\infty$ :

$$v(k, x) = e^{ikx} + o(1) \quad \text{as } x \rightarrow -\infty; \quad (13.5.5)$$

then

$$v(k, x) = A(k)e^{ikx} + B(k)e^{-ikx} + o(1) \quad \text{as } x \rightarrow +\infty. \quad (13.5.6)$$

Complex conjugate solution then

$$\bar{v}(k, x) = e^{-ikx} + o(1) \quad \text{as } x \rightarrow -\infty, \quad (13.5.7)$$

$$\bar{v}(k, x) = \bar{A}(k)e^{-ikx} + \bar{B}(k)e^{ikx} + o(1) \quad \text{as } x \rightarrow +\infty. \quad (13.5.8)$$

Their Wronskian  $W(v, \bar{v})$  must be constant (which follows from equation to Wronskian from ODE) and since  $W(v, \bar{v}) = W(e^{ikx}, e^{-ikx}) + o(1) = -2ik + o(1)$  as  $x \rightarrow -\infty$  and

$$W(v, \bar{v}) = W(A(k)e^{ikx} + B(k)e^{-ikx}, \quad (13.5.9)$$

$$\bar{A}(k)e^{-ikx} + \bar{B}(k)e^{ikx}) + o(1) = -2ik(|b(k)|^2 - |a(k)|^2) + o(1) \quad (13.5.10)$$

as  $x \rightarrow +\infty$  we conclude that

$$|A(k)|^2 - |B(k)|^2 = 1. \quad (13.5.11)$$

We interpret it as the wave  $A(k)e^{ikx}$  at  $+\infty$  meets a potential and part of it  $e^{ikx}$  passes to  $-\infty$  and another part  $B(k)e^{-ikx}$  reflects back to  $+\infty$ .

We observe that (13.5.11) means that the energy of the passed (refracted) and reflected waves together are equal to the energy of the original wave. We can observe that

$$A(-k) = \bar{A}(k), \quad B(-k) = \bar{B}(k). \quad (13.5.12)$$

Functions  $A(k)$  and  $B(k)$  are *scattering coefficients* and together with eigenvalues  $-k_j^2$

$$\phi_{j,xx} - V_j(x)\phi_j - k_j^2\phi_j = 0, \quad \phi_j \neq 0 \quad (13.5.13)$$

they completely define potential  $V$ .

### 13.5.3 Three dimensional scattering

Consider  $-\Delta$  as unperturbed operator and  $-\Delta + V(x)$  as perturbed where  $V(x)$  is smooth fast decaying at infinity potential. We ignore possible point

spectrum (which in this case will be finite and discrete). Let us consider perturbed wave equation

$$u_{tt} - \Delta u + V(x)u = 0; \quad (13.5.14)$$

it is simpler than Schrödinger equation. Let us consider its solution which behaves as  $t \rightarrow -\infty$  as a plane wave

$$u \sim u_{-\infty} = e^{ik(\boldsymbol{\omega} \cdot \mathbf{x} - t)} \quad \text{as } t \rightarrow -\infty. \quad (13.5.15)$$

with  $\boldsymbol{\omega} \in \mathbb{S}^2$  (that means  $\boldsymbol{\omega} \in \mathbb{R}^3$  and  $|\boldsymbol{\omega}| = 1$ ),  $k \geq 0$ .

**Theorem 13.5.1.** *If (13.5.15) holds then*

$$u \sim u_{+\infty} = e^{ik(\boldsymbol{\omega} \cdot \mathbf{x} - t)} + v(x)e^{-ikt} \quad \text{as } t \rightarrow +\infty. \quad (13.5.16)$$

where the second term in the right-hand expression is an outgoing spherical wave i.e.  $v(x)$  satisfies Helmholtz equation (9.1.19) and Sommerfeld radiation conditions (9.1.20)–(9.1.21) and moreover

$$v(x) \sim a(\boldsymbol{\theta}, \boldsymbol{\omega}; k)|x|^{-1}e^{ik|x|} \quad \text{as } x = r\boldsymbol{\theta}, r \rightarrow \infty, \boldsymbol{\theta} \in \mathbb{S}^2. \quad (13.5.17)$$

*Sketch of Proof.* Observe that  $(u - u_{-\infty})_{tt} - \Delta(u - u_{-\infty}) = f := -Vu$  and  $(u - u_{-\infty}) \sim 0$  as  $t \rightarrow -\infty$  and then applying Kirchhoff formula (9.1.12) with 0 initial data at  $t = -\infty$  we arrive to

$$u - u_{-\infty} = \frac{1}{4\pi} \iiint |x - y|^{-1} f(y, t - |x - y|) dy \quad (13.5.18)$$

and one can prove easily (13.5.17) from this.  $\square$

**Definition 13.5.1.**  $a(\boldsymbol{\theta}, \boldsymbol{\omega}; k)$  is *Scattering amplitude* and operator  $S(k) : L^2(\mathbb{S}^2) \rightarrow L^2(\mathbb{S}^2)$ ,

$$(S(k)w)(\boldsymbol{\theta}) = w(\boldsymbol{\theta}) + \iint_{\mathbb{S}^2} a(\boldsymbol{\theta}, \boldsymbol{\omega}; k)w(\boldsymbol{\omega}) d\sigma(\boldsymbol{\omega}) \quad (13.5.19)$$

is a *scattering matrix*.

It is known that

**Theorem 13.5.2.** *Scattering matrix is a unitary operator for each  $k$ :*

$$S^*(k)S(k) = S(k)S^*(k) = I. \quad (13.5.20)$$

*Remark 13.5.1.* (a) The similar results are proven when the *scatterer* is an obstacle rather than potential, or both.

(b) Determine scatterer from scattering amplitude is an important *Inverse scattering problem*.

(c) In fact *fast decaying at infinity* potential means decaying faster than Coulomb potential; for the latter theory needs to be heavily modified.

## More

Those who are interested in the spectral theory can see my talk

[Etudes in spectral theory](#)



# Chapter 14

## Miscellaneous

### 14.1 Conservation laws

#### 14.1.1 Theory

We start from example. Consider the liquid with density  $\rho = \rho(\mathbf{x}; t)$  and velocity  $\mathbf{v} = \mathbf{v}(\mathbf{x}; t)$ ,  $\mathbf{x} = (x_1, x_2, x_3)$ . Consider a small surface  $dS$  with a normal  $\mathbf{n}$  and let us calculate the quantity of the liquid passing through  $dS$  in the direction  $\mathbf{n}$  for time  $dt$ . It will be a volume swept by this surface shifted by  $\mathbf{v}dt$  and it will be equal to  $\mathbf{v} \cdot \mathbf{n} dS dt$ . It is negative as  $\mathbf{v} \cdot \mathbf{n} < 0$  which means that the liquid passed in the opposite direction is counted with the sign “-”. Then the mass will be  $\rho \mathbf{v} \cdot \mathbf{n} dS dt$  and if we consider now surface  $\Sigma$  which is not small we get the flux through  $\Sigma$  in the direction of  $\mathbf{n}$

$$\iint_{\Sigma} \rho \mathbf{v} \cdot \mathbf{n} dS \times dt. \quad (14.1.1)$$

Consider now volume  $V$  bounded by surface  $\Sigma$ . Then it contains  $\iiint_V \rho dV$  of the liquid; for time  $dt$  it is increased by

$$\iiint \rho_t dV \times dt;$$

on the other hand, the quantity of the liquid which arrived to  $V$  through  $\Sigma$  for time  $dt$  is given by (14.1.1) where  $\mathbf{n}$  is an inner normal to  $\Sigma$  and by Gauss formula (14.1.2) it is equal

$$- \iiint_V \nabla \cdot (\rho \mathbf{v}) dV \times dt.$$

Equalizing these two expressions and we get

$$\iiint_V (\rho_t + \nabla \cdot (\rho \mathbf{v})) dV = 0.$$

Since it holds for any volume  $V$  we conclude that

$$\rho_t + \nabla \cdot (\rho \mathbf{v}) = 0. \quad (14.1.2)$$

It is called *continuity equation* and it means the *conservation law*.

*Remark 14.1.1.* (a) It may happen that there is a *source* with the density  $f = f(\mathbf{x}, t)$  which means that for time  $dt$  in the volume  $V$  the quantity of the liquid  $\iiint_V f dV \times dt$  emerges (if  $f < 0$  we call it *sink*). Then (14.1.2) should be replaced by

$$\rho_t + \nabla \cdot (\rho \mathbf{v}) = f. \quad (14.1.3)$$

(b) Since  $\rho$  is a mass per unit volume,  $\mathbf{p} = \rho \mathbf{v}$  is a momentum per unit volume i.e. *density of momentum*.

(c) One can rewrite (14.1.2) as

$$\rho_t + \mathbf{v} \cdot \nabla \rho + \rho \nabla \cdot \mathbf{v} = \frac{d\rho}{dt} + \rho \nabla \cdot \mathbf{v} = 0 \quad (14.1.4)$$

where

$$\frac{d}{dt} = \frac{\partial}{\partial t} + \mathbf{v} \cdot \nabla \quad (14.1.5)$$

is a *differentiation along the trajectory*  $\frac{d\mathbf{x}}{dt} = \mathbf{v}$ .

(d) Instead of  $\rho$  usual density (of the mass) it could be an (electric) charge; then  $\mathbf{j} = \rho \mathbf{v}$  a *density of the current*. In fact  $\rho$  could be density of anything which is preserved and flows (rather than disappears in one place and emerges in the other).

(e) In fact, we can consider a mixture of particles; then  $\mathbf{v}$  is not defined but  $\mathbf{p}$  still is and equation

$$\rho_t + \nabla \cdot \mathbf{p} = 0 \quad (14.1.6)$$

makes sense.

**Definition 14.1.1.** Equation (14.1.6) which could be written as

$$\rho_t + \sum_j p_{j,x_j} = 0 \quad (14.1.7)$$

is called a *conservation law*.

*Remark 14.1.2.* Since not only scalar but also vector quantities could be conserved such conservation laws could be written in the form

$$p_{i,t} + \sum_j F_{ij,x_j} = 0, \quad i = 1, 2, 3. \quad (14.1.8)$$

Here  $F_{ij}$  is a *tensor* (more precise meaning of this word is not important here but those who specialize in mathematics or theoretical physics will learn it eventually). Using Einstein summation rule (which also indicates the nature of vector and tensors) one can rewrite (14.1.7) and (14.1.8) as

$$\rho_t + p_{x_j}^j = 0, \quad (14.1.9)$$

$$p_{i,t} + F_{i,x_j}^j = 0 \quad (14.1.10)$$

respectively.

## 14.1.2 Examples

*Example 14.1.1.* For wave equation

$$u_{tt} - c^2 \Delta u = 0 \quad (14.1.11)$$

the following conservation laws hold:

$$\partial_t \left( \frac{1}{2} (u_t^2 + c^2 |\nabla u|^2) \right) + \nabla \cdot \left( -c^2 u_t \nabla u \right) = 0; \quad (14.1.12)$$

and

$$\partial_t \left( u_t u_{x_i} \right) + \sum_j \partial_{x_j} \left( \frac{1}{2} (c^2 |\nabla u|^2 - u_t^2) \delta_{ij} - c^2 u_{x_i} u_{x_j} \right) = 0; \quad (14.1.13)$$

*Example 14.1.2.* For elasticity equation

$$\mathbf{u}_{tt} - \lambda \Delta \mathbf{u} - \mu \nabla (\nabla \cdot \mathbf{u}) = 0 \quad (14.1.14)$$

one can write conservation laws similar to (14.1.12) and (14.1.13) but they are too complicated; we mention only that in (14.1.12)  $\frac{1}{2}(u_t^2 + c^2|\nabla u|^2)$  is replaced by

$$\frac{1}{2}(|\mathbf{u}_t|^2 + \lambda|\nabla \otimes \mathbf{u}|^2 + \mu|\nabla \cdot \mathbf{u}|^2) \quad (14.1.15)$$

with  $|\nabla \otimes \mathbf{u}|^2 = \sum_{i,j} u_{j,x_i}^2$  as  $\mathbf{u} = (u_1, u_2, u_3)$ .

*Example 14.1.3.* For membrane equation

$$u_{tt} + \Delta^2 u = 0 \quad (14.1.16)$$

the following conservation law holds:

$$\partial_t \left( \frac{1}{2}(u_t^2 + \sum_{i,j} |u_{x_i x_j}^2) \right) + \sum_k \partial_{x_k} \left( \sum_j u_{x_j x_j x_k} u_t - u_{x_j x_k} u_{x_j t} \right) = 0. \quad (14.1.17)$$

*Example 14.1.4.* For Maxwell equations

$$\begin{cases} \mathbf{E}_t = \nabla \times \mathbf{H}, \\ \mathbf{H}_t = -\nabla \times \mathbf{E}, \\ \nabla \cdot \mathbf{E} = \nabla \cdot \mathbf{H} = 0 \end{cases} \quad (14.1.18)$$

the following conservation laws hold:

$$\partial_t \left( \frac{1}{2}(\mathbf{E}^2 + \mathbf{H}^2) \right) + \nabla \cdot (\mathbf{E} \times \mathbf{H}) = 0; \quad (14.1.19)$$

(where  $\mathbf{P} = \mathbf{E} \times \mathbf{H}$  is a Poynting vector) and if  $\mathbf{P} = (P_1, P_2, P_3)$  then

$$\partial_t P_k + \sum_j \partial_{x_j} \left( \frac{1}{2}(\mathbf{E}^2 + \mathbf{H}^2) \delta_{jk} - \mathbf{E}_j \mathbf{E}_k - \mathbf{H}_j \mathbf{H}_k \right) = 0. \quad (14.1.20)$$

*Example 14.1.5.* For Schrödinger equations

$$-i\hbar\psi_t = \frac{\hbar^2}{2m}\Delta\psi - V(\mathbf{x})\psi \quad (14.1.21)$$

the following conservation law holds:

$$\left( \bar{\psi}\psi \right)_t + \nabla \cdot \operatorname{Re} \left( -\frac{i\hbar}{m} \bar{\psi} \nabla \psi \right) = 0 \quad (14.1.22)$$

## 14.2 Maxwell equations

### 14.2.1 General form

$$\nabla \cdot \mathbf{E} = \frac{\rho}{\varepsilon_0} \quad (14.2.1)$$

$$\nabla \cdot \mathbf{B} = 0 \quad (14.2.2)$$

$$\nabla \times \mathbf{E} = -\frac{\partial \mathbf{B}}{\partial t} \quad (14.2.3)$$

$$\nabla \times \mathbf{B} = \mu_0 \mathbf{J} + \mu_0 \varepsilon_0 \frac{\partial \mathbf{E}}{\partial t} \quad (14.2.4)$$

where  $\rho$  and  $\mathbf{J}$  are density of charge and current, respectively. See in [Wikipedia](#).

*Remark 14.2.1.* (a) Equation (14.2.1) is a *Gauss' law*, (14.2.2) is a *Gauss' law for magnetism*, (14.2.3) is a *Faraday's law of induction*.

(b) Equations (14.2.1) and (14.2.4) imply *continuity equation*

$$\rho_t + \nabla \cdot \mathbf{J} = 0. \quad (14.2.5)$$

(c) In crystals (which are anisotropic)  $\varepsilon$  is not a scalar but a symmetric matrix. Then all equations below (in particular (14.2.6)) do not hold.

### 14.2.2 No charge and no current

In absence of the charge and current we get

$$\mathbf{E}_t = \mu^{-1} \varepsilon^{-1} \nabla \times \mathbf{B}, \quad \mathbf{B}_t = -\nabla \times \mathbf{E}$$

and then

$$\begin{aligned} \mathbf{E}_{tt} &= \mu^{-1} \varepsilon^{-1} \nabla \times \mathbf{B}_t = -\mu^{-1} \varepsilon^{-1} \nabla \times (\nabla \times \mathbf{E}) = \\ &= \mu^{-1} \varepsilon^{-1} (\Delta \mathbf{E} - \nabla(\nabla \cdot \mathbf{E})) = \mu^{-1} \varepsilon^{-1} \Delta \mathbf{E}; \end{aligned}$$

so we get a wave equation

$$\mathbf{E}_{tt} = c^2 \Delta \mathbf{E} \quad (14.2.6)$$

with  $c = 1/\sqrt{\mu\varepsilon}$ .

### 14.2.3 Field in the conductor

On the other hand, if we have a *relatively slowly changing field in the conductor*, then  $\rho = 0$ ,  $\mathbf{J} = \sigma \mathbf{E}$  where  $\sigma$  is a conductivity and we can neglect the last term in (14.2.4) and  $\nabla \times \mathbf{B} = \mu \sigma \mathbf{E}$  and

$$\begin{aligned} \mathbf{B}_t &= -\nabla \times \mathbf{E} = \mu^{-1} \sigma^{-1} \nabla \times (\nabla \times \mathbf{B}) = \\ &\mu^{-1} \sigma^{-1} (\Delta \mathbf{B} - \nabla(\nabla \cdot \mathbf{B})) = \mu^{-1} \sigma^{-1} (\Delta \mathbf{B}) \end{aligned}$$

so  $\mathbf{B}$  satisfies heat equation

$$\mathbf{B}_t = \mu_0^{-1} \sigma^{-1} \Delta \mathbf{B}. \quad (14.2.7)$$

## 14.3 Some quantum mechanical operators

### 14.3.1 General

In Quantum mechanics dynamics is described by

$$-i\hbar\psi_t + \mathbf{H}\psi = 0 \quad (14.3.1)$$

where  $\psi = \psi(\mathbf{x}, t)$  is a *wave function* and  $\mathbf{H}$  is a *quantum Hamiltonian*;  $\hbar$  is *Planck's constant*.

### 14.3.2 Classical Schrödinger operator

$$\mathbf{H} := \frac{1}{2m} (-i\hbar\nabla)^2 + eV(\mathbf{x}) = -\frac{\hbar^2}{2m} \Delta + V(\mathbf{x}) \quad (14.3.2)$$

Here  $V(x)$  is electric potential,  $e$  is particle's,  $m$  is particle's mass,  $-i\hbar\nabla$  is a (generalized) momentum operator.

If we add *magnetic field* with vector potential  $\mathbf{A}(\mathbf{x})$  we need to replace  $-i\hbar\nabla$  by  $\mathbf{P} = -i\hbar\nabla - e\mathbf{A}(\mathbf{x})$ :

$$\mathbf{H} := \frac{1}{2m} (-i\hbar\nabla - e\mathbf{A}(\mathbf{x}))^2 + eV(\mathbf{x}) \quad (14.3.3)$$

### 14.3.3 Schrödinger-Pauli operator

Particles with spin  $\frac{1}{2}$  are described by

$$\mathbf{H} := \frac{1}{2m} \left( (-i\hbar\nabla - e\mathbf{A}(\mathbf{x})) \cdot \boldsymbol{\sigma} \right)^2 + eV(\mathbf{x}) \quad (14.3.4)$$

where  $\boldsymbol{\sigma} = (\sigma_1, \sigma_2, \sigma_3)$  are  $2 \times 2$  Pauli matrices: namely Hermitian matrices satisfying

$$\sigma_j \sigma_k + \sigma_k \sigma_j = 2\delta_{jk} I \quad j, k = 1, 2, 3, \quad (14.3.5)$$

$I$  is as usual a unit matrix, and  $\psi$  is a complex 2-vector,

$$(-i\hbar\nabla - e\mathbf{A}(\mathbf{x})) \cdot \boldsymbol{\sigma} := \sum_{1 \leq k \leq 3} (-i\hbar\partial_{x_k} - eA_k(\mathbf{x}))\sigma_k. \quad (14.3.6)$$

*Remark 14.3.1.* It does not really matter which matrices satisfying (14.3.5). More precisely, we can replace  $\sigma_k$  by  $Q\sigma_k$  and  $\psi$  by  $Q\psi$  where  $Q$  is a unitary matrix and we can reduce our matrices to

$$\sigma_1 = \sigma_x = \begin{pmatrix} 0 & 1 \\ 1 & 0 \end{pmatrix}, \quad (14.3.7)$$

$$\sigma_2 = \sigma_y = \begin{pmatrix} 0 & -i \\ i & 0 \end{pmatrix}, \quad (14.3.8)$$

$$\sigma_3 = \sigma_z = \begin{pmatrix} 1 & 0 \\ 0 & -1 \end{pmatrix}. \quad (14.3.9)$$

Actually, it is not completely correct, as it may happen that instead of  $\sigma_3$  we get  $-\sigma_3$  but the remedy is simple: replace  $x_3$  by  $-x_3$  (changing orientation). We assume that our system is as written here.

*Remark 14.3.2.* Actually here and in Dirac operator  $\psi$  are not vectors but (spinors) <https://en.wikipedia.org/wiki/Spinor> which means that under rotation of coordinate system components of  $\psi$  are transformed in a special way.

Observe that

$$\begin{aligned} \left( (-i\hbar\nabla - e\mathbf{A}(\mathbf{x})) \cdot \boldsymbol{\sigma} \right)^2 = \\ (-i\hbar\nabla - e\mathbf{A}(\mathbf{x}))^2 + \sum_{j < k} [\sigma_j, \sigma_k][P_j, P_k], \end{aligned} \quad (14.3.10)$$

$$[P_j, P_k] = -i\hbar e(\partial_j A_k - \partial_k A_j) \quad (14.3.11)$$

and

$$[\sigma_1, \sigma_2] = i\sigma_3, \quad [\sigma_2, \sigma_3] = i\sigma_1, \quad [\sigma_3, \sigma_1] = i\sigma_2. \quad (14.3.12)$$

Then

$$\left( (-i\hbar\nabla - e\mathbf{A}(\mathbf{x})) \cdot \boldsymbol{\sigma} \right)^2 = (-i\hbar\nabla - e\mathbf{A}(\mathbf{x}))^2 - e\hbar\mathbf{B}(\mathbf{x}) \cdot \boldsymbol{\sigma}, \quad (14.3.13)$$

where  $\mathbf{B} = \nabla \times \mathbf{A}$  is a *vector intensity* of magnetic field.

### 14.3.4 Dirac operator

$$\mathbb{H} := (-i\hbar\nabla - e\mathbf{A}(\mathbf{x})) \cdot \boldsymbol{\gamma} + m\gamma_4 + eV(\mathbf{x}) \quad (14.3.14)$$

where  $\boldsymbol{\gamma} = (\gamma_1, \gamma_2, \gamma_3)$  are  $4 \times 4$  Dirac matrices: namely Hermitian matrices satisfying (14.3.5) for  $j, k = 1, 2, 3, 4$ . Respectively  $\psi$  is 4-vector.

As  $V = 0$

$$\mathbb{H}^2 = \left( (-i\hbar\nabla - e\mathbf{A}(\mathbf{x})) \cdot \boldsymbol{\gamma} \right)^2 + m^2 I \quad (14.3.15)$$

Again, the precise choice of Dirac matrices is of no importance and one can

assume that  $\gamma_j = I_2 \otimes \sigma_j := \begin{pmatrix} \sigma_j & 0 \\ 0 & \sigma_j \end{pmatrix}$  for  $j = 1, 2, 3$  and

$\gamma_4 = \begin{pmatrix} 0 & 1 \\ -1 & 0 \end{pmatrix} \otimes I_2 := \begin{pmatrix} 0 & I_2 \\ -I_2 & 0 \end{pmatrix}$  (all blocks are  $2 \times 2$  matrices). Then

$$\mathbb{H}^2 = (-i\hbar\nabla - e\mathbf{A}(\mathbf{x}))^2 - \mathbf{B}(\mathbf{x}) \cdot \boldsymbol{\gamma} + m^2 I. \quad (14.3.16)$$



# Appendix A

## Appendices

### A.1 Field theory

#### A.1.1 Green, Gauss, Stokes formulae

Let  $D$  be a bounded domain in  $\mathbb{R}^2$  and  $L = \partial D$  be its boundary. Then

$$-\int_L \mathbf{A} \cdot \mathbf{n} \, ds = \iint_D (\nabla \cdot \mathbf{A}) \, dS \quad (\text{A.1.1})$$

where the left-hand side expression is a linear integral, the right-hand side expression is an area integral and  $\mathbf{n}$  is a unit inner normal to  $L$ . This is *Green formula*.

Let  $V$  be a bounded domain in  $\mathbb{R}^3$  and  $\Sigma = \partial V$  be its boundary. Then

$$-\iiint_{\Sigma} \mathbf{A} \cdot \mathbf{n} \, dS = \iiint_D (\nabla \cdot \mathbf{A}) \, dV \quad (\text{A.1.2})$$

where the left-hand side expression is a surface integral, the right-hand side expression is a volume integral and  $\mathbf{n}$  is a unit inner normal to  $\Sigma$ . This is *Gauss formula*.

*Remark A.1.1.* (a) Here sign “−” appears because  $\mathbf{n}$  is a unit *inner* normal.

(b) Gauss formula holds in any dimension. It also holds in any “straight” coordinate system.

(c) In the curvilinear coordinate system  $(u_1, \dots, u_n)$  in also holds but divergence must be calculated as

$$\nabla \cdot \mathbf{A} = \sum_k J^{-1} \partial_{u_k} (A^k J) = \sum_k \partial_{u_k} A^k + \sum_k (\partial_{u_k} \ln J) A^k \quad (\text{A.1.3})$$

where  $J du_1 \dots du_n$  is a volume form in these coordinates. F.e. in the spherical coordinates if  $\mathbf{A}$  is radial,  $\mathbf{A} = A_r \mathbf{r}/r$  (with  $r = |\mathbf{r}|$  we have  $\partial_r \ln J = (n-1)r^{-1}$  and therefore  $\nabla \cdot A_r \mathbf{r}/r = \partial_r A_r + (n-1)r^{-1} A_r$ .

Let  $D$  be a bounded domain in  $\mathbb{R}^2$  and  $L = \partial D$  be its boundary, counter-clockwise oriented (if  $L$  has several components then inner components should be clockwise oriented). Then

$$\oint_L \mathbf{A} \cdot d\mathbf{r} = \iint_D (\nabla \times \mathbf{A}) \cdot \mathbf{n} dS \quad (\text{A.1.4})$$

where the left-hand side expression is a line integral, the right-hand side expression is an area integral and  $\mathbf{n} = \mathbf{k}$ . This is *Green formula* again.

Let  $\Sigma$  be a bounded piece of the surface in  $\mathbb{R}^3$  and  $L = \partial \Sigma$  be its boundary. Then

$$\oint_L \mathbf{A} \cdot d\mathbf{l} = \iint_{\Sigma} (\nabla \times \mathbf{A}) \cdot \mathbf{n} dS \quad (\text{A.1.5})$$

where the left-hand side expression is a line integral, the right-hand side expression is a surface integral and  $\mathbf{n}$  is a unit normal to  $\Sigma$ ; orientation of  $L$  should match to direction of  $\mathbf{n}$ . This is *Stokes formula*.

*Remark A.1.2.* (a) We can describe orientation in the Green formula as “the pair  $\{d\mathbf{r}, \mathbf{n}\}$  has a right-hand orientation”.

(b) We can describe orientation in the Stokes formula as “the triple  $\{d\mathbf{r}, \boldsymbol{\nu}, \mathbf{n}\}$  has a right-hand orientation” where  $\boldsymbol{\nu}$  is a normal to  $L$  which is tangent to  $\Sigma$  and directed inside of  $\Sigma$ .

(c) Stokes formula holds in any dimension of the surface  $\Sigma$  but then it should be formulated in terms of differential forms

$$\int_{\Sigma} d\omega = \int_{\partial \Sigma} \omega \quad (\text{Stokes formula})$$

which is the material of Analysis II class (aka Calculus II Pro).

### A.1.2 Definitions

**Definition A.1.1.** (a) Operator  $\nabla$  is defined as

$$\nabla = \mathbf{i}\partial_x + \mathbf{j}\partial_y + \mathbf{k}\partial_z. \quad (\text{A.1.6})$$

(b) It could be applied to a scalar function resulting in its gradient ( $\text{grad } \phi$ ):

$$\nabla\phi = \mathbf{i}\partial_x\phi + \mathbf{j}\partial_y\phi + \mathbf{k}\partial_z\phi$$

(c) and to vector function  $\mathbf{A} = A_x\mathbf{i} + A_y\mathbf{j} + A_z\mathbf{k}$  resulting in its divergence ( $\text{div } \mathbf{A}$ )

$$\nabla \cdot \mathbf{A} = \partial_x A_x + \partial_y A_y + \partial_z A_z$$

(d) and also in its curl ( $\text{curl } \mathbf{A}$ ) or rotor ( $\text{rot } \mathbf{A}$ ), depending on the mathematical tradition:

$$\nabla \times \mathbf{A} = \begin{vmatrix} \mathbf{i} & \mathbf{j} & \mathbf{k} \\ \partial_x & \partial_y & \partial_z \\ A_x & A_y & A_z \end{vmatrix}$$

which is equal to

$$(\partial_y A_z - \partial_z A_y)\mathbf{i} + (\partial_z A_x - \partial_x A_z)\mathbf{j} + (\partial_x A_y - \partial_y A_x)\mathbf{k}.$$

### A.1.3 Double application

**Definition A.1.2.**

$$\Delta = \nabla^2 = \nabla \cdot \nabla = \partial_x^2 + \partial_y^2 + \partial_z^2. \quad (\text{A.1.7})$$

is *Laplace operator* or simply *Laplacian*.

There are four formulae to remember:

$$\nabla(\nabla\phi) = \Delta\phi, \quad (\text{A.1.8})$$

$$\nabla \times (\nabla\phi) = 0, \quad (\text{A.1.9})$$

$$\nabla \cdot (\nabla \times \mathbf{A}) = 0, \quad (\text{A.1.10})$$

$$\nabla \times (\nabla \times \mathbf{A}) = -\Delta\mathbf{A} + \nabla(\nabla \cdot \mathbf{A}) \quad (\text{A.1.11})$$

where all but the last one are obvious and the last one follows from

$$\mathbf{a} \times (\mathbf{a} \times \mathbf{b}) = -\mathbf{a}^2 \mathbf{b} + (\mathbf{a} \cdot \mathbf{b}) \mathbf{a} \quad (\text{A.1.12})$$

which is the special case of

$$\mathbf{a} \times (\mathbf{b} \times \mathbf{c}) = \mathbf{b}(\mathbf{a} \cdot \mathbf{c}) - \mathbf{c}(\mathbf{a} \cdot \mathbf{b}). \quad (\text{A.1.13})$$

*Exercise A.1.1.* (a) Prove these formulae.

(b) Rewrite these formulae, using grad, div and curl, where appropriate.

### A.1.4 Application to the product

Recall *Leibniz rule* how to apply the first derivative to the product which can be symbolically written as

$$\partial(uv) = (\partial_u + \partial_v)(uv) = \partial_u(uv) + \partial_v(uv) = v\partial_u(u) + u\partial_v(v) = v\partial u + u\partial v$$

where subscripts “ $u$ ” or “ $v$ ” mean that it should be applied to  $u$  or  $v$  only.

Since  $\nabla$  is a linear combination of the first derivatives, it inherits the same rule. Three formulae are easy

$$\nabla(\phi\psi) = \phi\nabla\psi + \psi\nabla\phi, \quad (\text{A.1.14})$$

$$\nabla \cdot (\phi\mathbf{A}) = \phi\nabla \cdot \mathbf{A} + \nabla\phi \cdot \mathbf{A}, \quad (\text{A.1.15})$$

$$\nabla \times (\phi\mathbf{A}) = \phi\nabla \times \mathbf{A} + \nabla\phi \times \mathbf{A}, \quad (\text{A.1.16})$$

and the fourth follows from the Leibniz rule and (A.1.13)

$$\begin{aligned} \nabla \times (\mathbf{A} \times \mathbf{B}) = \\ (\mathbf{B} \cdot \nabla)\mathbf{A} - \mathbf{B}(\nabla \cdot \mathbf{A}) - (\mathbf{A} \cdot \nabla)\mathbf{B} + \mathbf{A}(\nabla \cdot \mathbf{B}). \end{aligned} \quad (\text{A.1.17})$$

*Exercise A.1.2.* (a) Prove these formulae.

(b) Rewrite these formulae, using grad, div and curl, where appropriate.

## A.2 Some notations

Compare behaviour of two functions  $f(\boldsymbol{x})$  and  $g(\boldsymbol{x})$  as  $\boldsymbol{x}$  “tends to something” (in the usage it is clear).

**Definition A.2.1.** (a)  $f = O(g)$  : if  $f/g$  is bounded:  $|f| \leq M|g|$  with some constant  $M$ ;

(b)  $f = o(g)$  : if  $f/g \rightarrow 0$ :  $\lim(f/g) = 0$ ;

(c)  $f \sim g$  : if  $f/g \rightarrow 1$ :  $\lim(f/g) = 1$  which is equivalent to  $f = g + o(g)$  or  $f = g(1 + o(1))$ ;

(d)  $f \asymp g$  : if  $f = O(g)$  and  $g = O(f)$  which means that  $M^{-1}|g| \leq f \leq M|g|$ . We say then that  $f$  and  $g$  have the same magnitudes.

Obviously (c) implies (d) but (d) does not imply (c).

See in details [https://en.wikipedia.org/wiki/Big\\_O\\_notation](https://en.wikipedia.org/wiki/Big_O_notation); also  $\Omega$  notation (which we do not use).